



## **History of the New York and Philadelphia Coastal Defenses, 1944**

This .pdf is a scanned historical document which screen readers for the visually impaired may find difficult reading.

If you are have difficulty accessing this document and would still like to learn more about the topic of this document, please contact the park using the contact information below.

Thank you!

Point of Contact: Thomas Hoffman, Sandy Hook Historian  
[Tom\\_Hoffman@nps.gov](mailto:Tom_Hoffman@nps.gov)

SECRET

SECRET  
:Auth: CG, SES, EDC:  
:Date: 18 July 1944:  
:Initials: BM:  
:

23325

TABLE OF CONTENTS

INTRODUCTION

SECTION I - Background of Sector

SECTION II - Sector in Operation

Part 1 - General

Part 2 - Liaison, HECP and The Amagansett Affair

Part 3 - Troops of Sector

SECTION III- Subsectors and Harbor Defenses in Operation

Part 1 - New York Subsector and Harbor Defenses of New York  
(HECP, Forts and Armament)

Part 2 - Philadelphia Subsector and Harbor Defenses of  
The Delaware  
(HECP, Forts and Armament)

SECTION IV - General Information

Story of Headquarters  
Coast Artillery District, Sector Commanders  
Coastal Defense (Definitions)  
Harbor Defense Units  
Categories of Defense  
Classes of Material

SECURITY CLASSIFICATION REVIEWED  
& JUSTIFIED BY (A. B. S. G. C. N.)  
AUTH SEC ARMY BY TAG PER 9 KK 38

SECRET

## INTRODUCTION

This is the story of the New York-Philadelphia Sector in the Second World War, the story of the men who wore the two red shells on the field of gold bordered in olive drab. It was this team of Coast Artillery, Field Artillery, Infantry, tanks and anti-aircraft that stood guard with Navy and Coast Guard on a front of nearly 300 miles of United States Coastline. Few Realize the scope of the work they did. No great battles marked Sector's history. The task of the two red shells was the unspectacular task of constant vigilance while others carried the fight to the enemy secure in the knowledge that at their back stood a guarded shore, the ramparts of New York-Philadelphia Sector, joined with the New England Sector, Chesapeake Bay Sector and Southern Sector in the Eastern Defense Command.

They faced the great water barrier that has stood between Europe and the United States since the beginning of time, the Atlantic Ocean. Today this ocean has shrunk and the mere span of water is not enough to obtain the security of our Nation in war. To guarantee the tactical advantage of this Atlantic barrier the shore must be guarded. How the task was accomplished is an example of military team work worthy of a place in the annals of our military history.

Basically water barriers are the major terrain that govern the tactics of an army either in attack or defense. And, the world being what it is, military expediency governs the boundaries of nations and even dictates the racial cleavage of peoples. With few exceptions, where mountain ranges furnish the barriers, you will find rivers, seas or chains of lakes on your national boundaries.

The economic scheme of existence of nations also is measured by coastlines - or an outlet to the sea. It is for these ports that nations wage war as a starving man commits violence to obtain food denied him by a social order against which he wars. By the same reasoning those who thirst for power first attempt to grasp control of ports.

A "corridor" to the sea was the immediate cause of the present war. No matter what the madmen of Germany intended in the long run it was Poland's resistance to the demand that would cost her her outlet to the sea that touched the fuse that brought England and France in the conflict and ultimately the United States. It was the now historically famous Polish Corridor.

Thereafter it became a battle of coastlines. Neither Forrest nor Maginot Line stopped the power of the arms of the enemy. The English Channel, the coastal defense of England, did. Even airpower had to measure its strategic success in terms of coastline defense. It was not a question of merely transporting fire power across a channel; that fire power had to knock out the defense of a coastline. The success of Dunkirk could not be cashed by Germany otherwise.

It never happened! Bulwarked by Churchill's "valiant few", England's front across the channel remained unbreached. Germany's leaders, even swollen by success as they were, did not dare to cross the stretch of water. And so France was overrun, not England.

New England is an armed camp, a threat aimed at the conquered lands

across that same channel, a threat of English, Canadian, and American might behind the same bulwark, the coastal defenses along the English Channel.

The Mediterranean was another question of a battle of coastlines. With fallen France and Greece, and Italy on one side, and enemy-controlled North Africa on the other, the Mediterranean was closed to the Allies. Long voyages, with resultant loss of time, were forced on our military strategists to reach the back doors of India, Iran and Australia. We were forced to the perilous Northern route to supply Russia.

Then our coast, the Eastern seaboard of the United States attacked that coast, first Africa, then Sicily, then Italy itself - and held on. It worked in that direction, eastward. We did not let it work in reverse, westward.

The fact is evident that no matter how planes, ships or whatever manner of means is conceived to bring firepower across a water barrier, increase in range or destructive effect, the attack is always from shore to shore. The attack is from one shore, and the blow falls on the other with an army ready to step on the beaches when the defenses are neutralized. The attack will fall on the coast, the attack will start from the coast.

The Pacific coast also faced its problem with its coastal outposts of the Philippines and Wake Island fallen. But it is with this Atlantic, the "no man's land" of the Eastern Defense Command and the New York-Philadelphia Sector, that we are concerned. And for the Sector the "front line" was not so far away. Oil on our beaches from sunken tankers was mute evidence of battles lost, bodies of seaman on our shores mute testimony to the cost in lives, wreckage in our surf telling the cost in ships and labor on cargoes.

That was the fight that Sector had to fight.

And how did Sector meet the threat? The history of this effort, its problems and solutions is the purpose of this chronicle.

Through the history of the United States "Sector," the territory included in Sector's present-day boundaries, has been one of the major battlegrounds of the would-be possessor of North America. The Indian knew no problem of coastal defense and yielded beachhead to Dutchman, Swede and Englishman by default. The Indian lost a continent.

The first white settlers built of earth and logs forts to guard their rivers before they planted their crops. And as America grew in stature and as the Atlantic "barrier" even then began its shrinking process as sail gave way to steam, the forts of old became stone bulwarks close against the cities they would protect. Then the Navy took care of the outer seas and once the line of ships was breached or evaded the forts held the enemy from the cities. But these cities were then useless ports - blockaded. They were denied to friend and foe alike. This was coastal defense with a capital D.

But today, facing the new enemy with his swift warship and plane, and his hidden submarine, a new defense was to be devised. The new defense was to be in reality an aggressive offense that was to reach hundreds of miles to sea with coastal troops, armament, warships and airpower welded into one bristling war machine, ready for action over, under or on the Atlantic Ocean. It is more than a defense, it is America's first line of attack to the east.

It is a line of attack because it is from these shores that our strength must flow toward the enemy. It is from Boston, New York, Philadelphia, Norfolk, Charleston and other ports and airfields that our ships of war, ships laden with troops, ships laden with cargoes must depart and be able to return. The enemy had to be - and was - driven back from the approaches to our ports. Navy bases must be held safe, cities must labor and build, railroads had to run, the people on our seaboard were not to be refugees.



The center of that line, the keystone of attack, is the New York-Philadelphia Sector.

Sector activities in this present day stage of development of warfare have assumed such proportions and indulged in such ramifications that the immensity of the project is apt to be lost in the details. The individual is likely to lose the sense of the size of the problem that faces a command in defense of a populated coastline or the measure of success that rewards the effort. In fact it is one of the evidences of success that so little is realized of the effort.

Not one of the least phases of coastal defense is the shield of silence that has to be thrown about the activities of our coast, a shield not against enemy shells or bombs but against information reaching our foes. Our campaign was one for silence waged through poster, motion picture, platform speaker and radio speaker as far as the thoughtless individual in our ranks at home was concerned. Our planes and ships, our beach patrolman watched to keep enemy eyes off our bastions of supply. It was Sector's job to deny the foe the details of the "jig saw" military puzzle.

As an example we may cite the final phase of the African Campaign that was launched with such suddenness on the coastline of Vichy French held territory. The French were reluctant defenders but bulwarked by any sizable Nazi force would have had to fight in a more determined spirit.

As the forces were gathered for the blow, armadas sailed from eastern U.S. ports to power the push. Had these armadas been observed and the information "leaked", the enemy would have been given the key to the situation far enough in advance to blunt the attack, if not to foil it altogether, with a resultant higher toll in American lives and material. So, in the final analysis, it is a function of "defense" over here to guarantee success of the attack over there. How well we succeeded can be judged by the war map today that shows all North Africa in Allied hands, North Africa, the starting point for the attacks on Sicily and Italy.

Specifically, the New York-Philadelphia Sector includes that section of the eastern seaboard that extends from the Connecticut, New York border on the north to the Delaware, Maryland border, and on the south, including virtually all of Long Island. In its care are placed the entrance to two of the Nation's most valuable harbors; harbors that are gateways from the sea to the nation's two largest cities, New York and Philadelphia. The density of the population, mile for mile is greater than any other section of our coast line. The value of property in Sector's care runs in astronomical figures. Board a train south of Wilmington, Del., and ride to New York City and before the train windows will unroll a panorama of industry, from ships to ball bearings, that should impress any observer. With a little imagination one can easily conceive that havoc that could be created in such a concentration of industrial activity by an attack by an enemy force, however isolated.

And on the flanks of the New York-Philadelphia Sector, a responsibility that is bound to be shared by Sector, rests two other great port entrances, those to Boston on the North and Norfolk and Baltimore to the South.

These properties, valuable as they may be, are only a small part of the picture for these ports represent the nerve ends of transportation and industry that extend into the vitals of the nation, the farm lands, the mines and the mills.

That the potential danger to this National treasure has not resolved itself into disaster upon attack by an enemy can be taken as some measure of the

success of Sector defense. That the danger didn't exist cannot be claimed for on the "frontier" of this battleground of the coast the enemy did have some degree of success with undersea boat and raider that should be a signboard, to anyone who gives it thought, to what might have been if he had ever been permitted to close in.

The result of these somewhat minimized "battle reverses" was perhaps the major discomfort of John Q Public in this war, the exchange of his automobile for crowded bus and train. From a military standpoint the loss of ships to carry war supplies overseas and the loss of these supplies themselves as cargoes was vastly more important.

While this outlying battleground was primarily a function of Navy operation, it was in the broad sense the initial contact the Eastern Defense Command, of which Sector is a part, had with the enemy. In the war of this day all forces are bound so closely together in their efforts that the responsibility is one for Army, Navy or Air. Sector employes all of these arms although is commands but a part. With this situation in mind the inclusion of "defense" in the title of command is somewhat of a misnomer for ~~it is~~ only from one standpoint a static defense. We repeat that in the big picture it is a function of attack, it is the coast of the United States, and particularly that of the New York-Philadelphia Sector, that is the springboard for attack. If the enemy moves in our direction we defend (by attacking), but succeeding in this dynamic defense we send out the sinews of war that will beat the enemy to his knees on his own shores, in his own cities -- NOT OURS. To this end we worked, for a sustained and successful campaign. Only fairy tale armies spring fully equipped from the earth to do battle.

Without a battle it is hard to point to a victory. However in New York-Philadelphia Sector; Back of its beach patrols, its fortifications, its airfields stand its navy yards unscathed, its shipyards still building, its factories still operating, its business intact, its railroads running and its homes serene. This after all is the measure of success, the success of a mission, an enemy held from our shores. And all this was accomplished on the busy front doorstep of the United States at the cost of a few dimmed lights and darkened seashore communities.

This is the story of this effort, Sector's "Victory of Security".

SECTION I

BACKGROUND OF SECTOR

9-38

9-38

The plans for costal defense were laid long before the National emergency that ended in the declarations of war on December 7, 1941 was felt by the public. This planning , was the result of the realization of military leaders that a well knit plan of cooperation between Army and Navy was necessary if the nation was to be able to throw its full strength against any foe attempting to assault our shores. The plan was to undergo a number of alterations as experience and the development of the military problem dictated.

The basic plan or the first plan to be considered in this survey was that of The Joint Board, 1927 as revised by the Joint Board in 1935.

in 1935 we find the United States divided into four huge Army Areas, further subdivided into nine Army Corps areas. The Navy divided the nation into thirteen Naval Districts. The boundaries of the Army and Navy command did not coincide. In the northeastern United States the discrepancies were slight while in the southeast, interior of United States and on the west coast the boundaries were at greater variance. On the coasts a Corps Area was apt to include more than one Naval District as on the west coast where the Ninth Corps Area included parts of three Naval Districts, the seventh, twelfth and thirteenth, or on the east coast where the Fourth Corps Area included the Sixth, Seventh and part of the Eight Naval Districts. In the interior the condition was reversed such as where the Ninth Naval District included almost all of the Sixth and Seventh Corps Areas. This was to be expected when the missions of Army and Navy are considered.

But when faced with the problem of coastal defense and the imperative demand for cooperation between the services it becomes evident that a coincidence of command in corps area and naval district must be sought.

The 1935 "Joint Action" plan met this problem by dividing the coasts of the

SECRET

(1)

SECURITY CLASSIFICATION REVIEWED  
& JUSTIFIED (NOT A REVISION)  
AUTH SEC ARMY BY TAG PER 1 KK 35

United States into four parcels, the North Atlantic Coastal Frontier that stretched from Maine to North Carolina; the Southern Coastal Frontier that stretched from North Carolina to the Mexican Border; the Great Lakes Coastal Frontier that covered the Great Lakes on the Canadian Border, and the Pacific Coastal Frontier that included the entire Pacific Coast.

These frontiers were then further divided into sectors and subsectors, whose boundaries, in all cases, coincided with naval district boundaries but not with corps area boundaries. However, generally, the frontier boundaries did coincide with those of army areas - the First Army backed the North Atlantic Frontier; the Third Army backed the Southern Coastal Frontier; the Second Army backed the Great Lakes Coastal Frontier and the Fourth Army the Pacific Coastal Frontier.

Since coastal frontier defense involved just what the name implied it is evident that the brunt of the first attack on our shores would fall on the navy and the Coast Artillery Corps in turn. The transition from peace to war would therefore concern most vitally as far as the Army is concerned, the Coast Artillery District in the matter of frontier defense.

The Coast Artillery District is a military command within a certain corps area which contains harbor defenses. It is established for the purpose of decentralizing the corps area commanders functions of discipline, instruction and routine training of the coast artillery troops within the corps area. This definition of a coast artillery districts makes the next step an obvious one since "routine" ends in an emergency. According to the wording of the 1935 plan:

"When frontier commands, sectors, and subsectors come into active existence, coast artillery districts, as such, cease to exist and all coast artillery troops, including the district staff, located within the frontier, sector, or subsector automatically become a part of the frontier, sector, or subsector command, as the case may be. The coast artillery district commander automatically becomes a coastal frontier or sector commander, as prescribed ..... or (as called for) in

SECRET

specific war plans. As frontier commander, he is responsible to the army commander as long as the latter retains tactical responsibility with the area. Upon departure of the army commander, the frontier commander is responsible directly to the commanding general of the field forces."

The picture of command, under the 1935 proposal, would have changed as depicted for the North Atlantic coast, the area in which the now Philadelphia, New York Sector lies, had an emergency caused the activation of sector as such before 1941 (see plates Nos. 1 and 2).

However this basic proposal was made flexible permitting lower echelons of command to alter, refine and improve; through proper channel and always within the confines of the overall plan; the details of cooperation between corps area on one hand and the naval district on the other.

The machinery for this function was set up by War and Navy Department in 1923 and incorporated in the 1935 Joint Action which states;

"Commanding generals of departments, armies and/or corps areas, and commandants of naval districts whose headquarters are in the same vicinity, (will) appoint from among their immediately available officer personnel not more than three officers from each service to constitute a permanent local joint planning committee. ....

"The local joint planning committee takes cognizance of questions referred to it by proper authority and originates questions on such local subjects as, in its judgement, are necessary. Its reports and recommendations are made jointly to the commanding general and commandant of the naval district concerned."

Watching over these activities of local planners was the Joint Economy Board of the War and Navy Departments ..... "charged with continuing responsibility of investigating and reporting to the The Joint Board on economies which can be effected, from time to time, without loss of efficiency, by the elimination of overlap or the simplification of functioning in those activities of the War and Navy Departments concerned with joint operations of the two services, or which have approximately parallel functions."

Generally speaking, however, this condition for the joint action of Army and Navy on the East Coast held until crisis in World affairs had reached the

BEFORE EMERGENCY ACTION

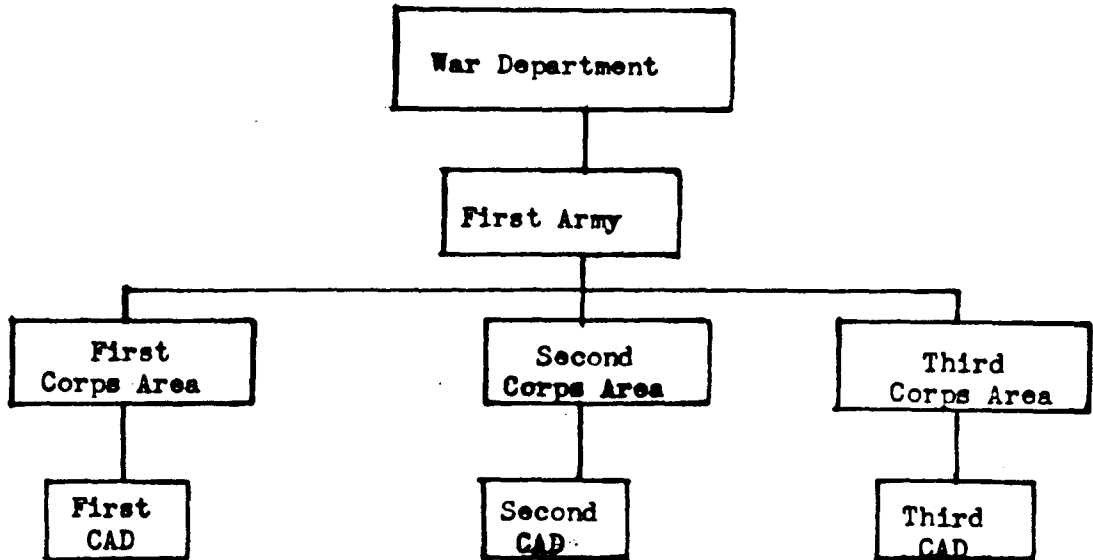

IN EMERGENCY ACTION

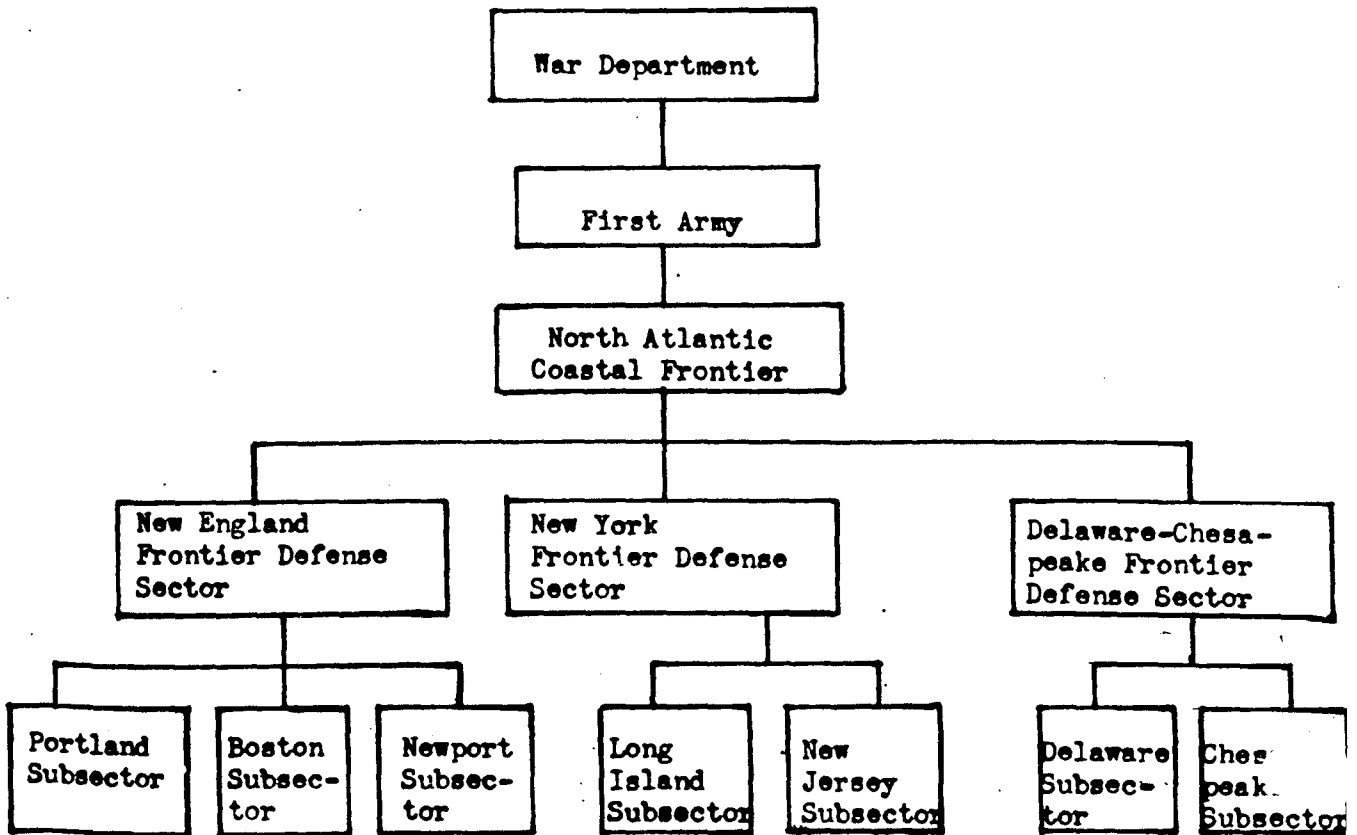

GREAT LAKES  
COASTAL FRONTIER

BOUNDARIES OF  
SECTORS AND SUBSECTORS  
BEFORE 1917 PLAN FOR THE DEFENSE  
OF THE NORTHEASTERN THEATER

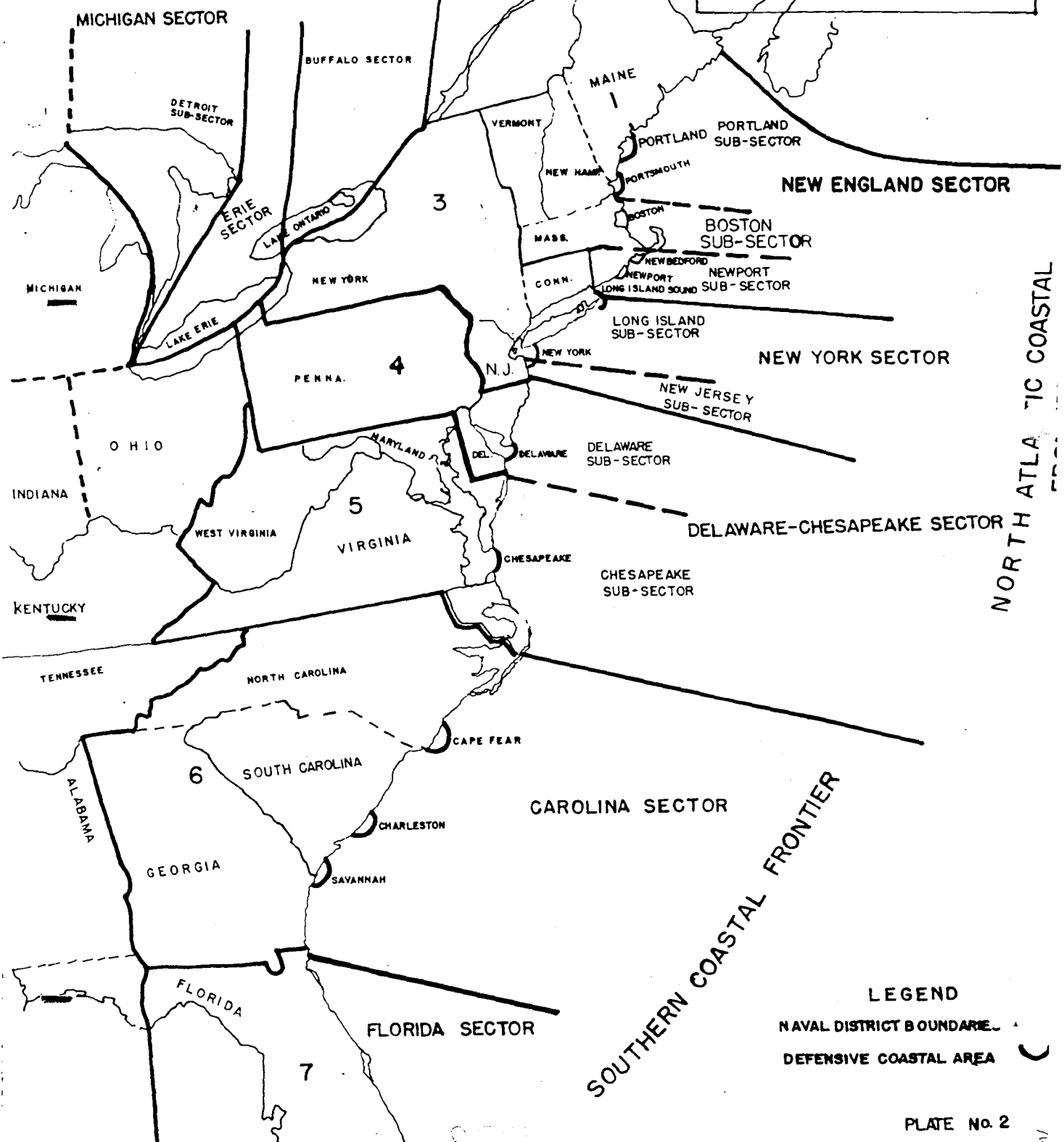

NORTH ATLANTIC COASTAL FRONTIER

SOUTHERN COASTAL FRONTIER

LEGEND  
 NAVAL DISTRICT BOUNDARIES  
 DEFENSIVE COASTAL AREA



point that brought the war too close to the shores of the United States for measures of strict neutrality and eventually pushed our country into the war in December 1941.

On September 2, 1940 the United States exchanged 50 World War I destroyers for bases on British territory on this side of the Atlantic. On April 9, 1941 United States Forces were sent to Greenland and on July 7, 1941 United States forces were sent to Iceland.

On August 21, 1941 the President of the United States extended the training period of the National Guard and Inductees on the Selective Service and Training Act of 1940 to eighteen months instead of a year. On November 17, 1941, the bill was signed permitting the arming of U.S. merchant ships and their entry into all combat zones. On November 24, 1941 the United States occupation of Dutch Guiana was announced.

In the flurry of all this pre-war activity a new plan of coastal defense was evolved, a Northeastern Theater was created and Sector boundaries were shifted. When war was declared against Japan by the United States on December 8, 1941, and on Germany and Italy on December 11, 1941 it was that plan that was placed in action to meet the emergency of World War II.

Several moves had been made by the War Department in the interim, however, moves that were gradually swinging the Army in Continental United States from a peace time to a war time basis and although the so-called "Northeastern Theater Plan" was the basis of operations on the outbreak of war, another, more comprehensive plan, the "Northeast Defense Command Plan" was even then in preparation and was soon to supersede the local plan.

The first of these interim moves came shortly after Congress had passed the Selective Service Act, September 16, 1940, when the War Department issued a

directive on 3 October, 1940 (Ref. 62.2/154) by which the Army was separated from the Corps Area. It was ordered that Army Headquarters be separated from Corps Area Headquarters not later than November 15, 1940 although they could be separated prior to that date at the option of Army Commanders. Further that "otherwise, this directive becomes effective as groupings are established ....." This action relieved tactical commanders of the onus of responsibility for or supervision over Corps Area activities.

The grouping of divisions and corps in the large tactical units for training and tactical supervision was announced on October 7, 1940. The tactical setup for the First Army was as follows:

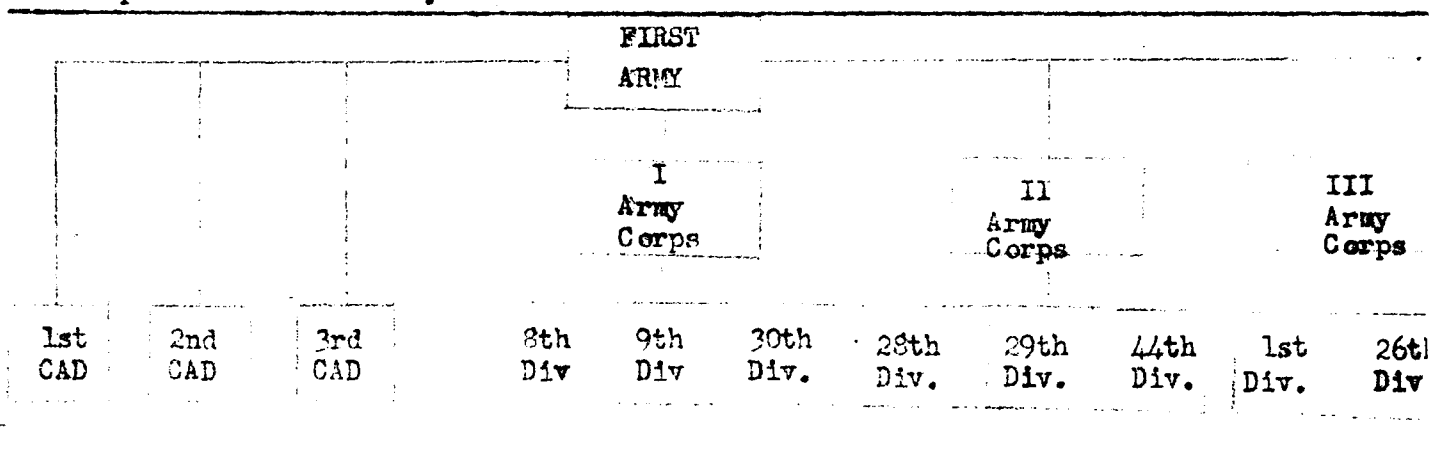

Ref. 660.3/131, 126, 127 LJPC 2nd CAD; 381/3 NET

A plan for the Defense of the Northeastern Theater was sent from First Army Headquarters to the Commanding General, Second Coast Artillery District March 17, 1941. It was in this plan that the boundaries of the original New York Sector were extended southward to include the Harbor Defense of the Delaware and "sector" was redesignated the "New York-Philadelphia Sector of the North Atlantic Coastal Frontier", or briefly "New York-Philadelphia Frontier Sector."

This reorganization of plans for the defense of Continental United States was brought about by the separation of the Army from the Corps Area and an interim or "stop gap" plan was to be drawn up by the Northeastern Theater Joint Planning

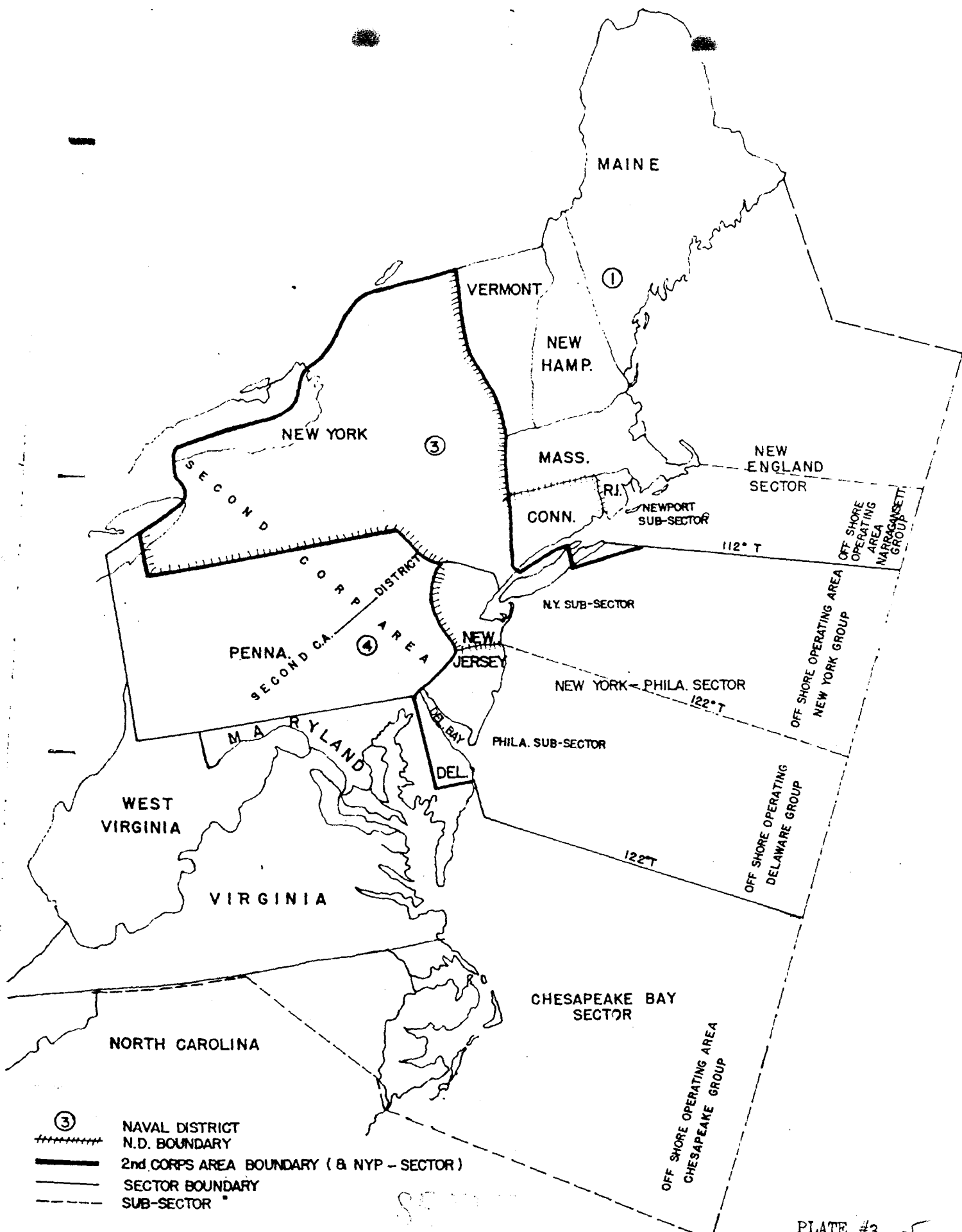

- ③ NAVAL DISTRICT
- +++++ N.D. BOUNDARY
- 2nd CORPS AREA BOUNDARY ( & NYP - SECTOR )
- SECTOR BOUNDARY
- - - - - SUB-SECTOR

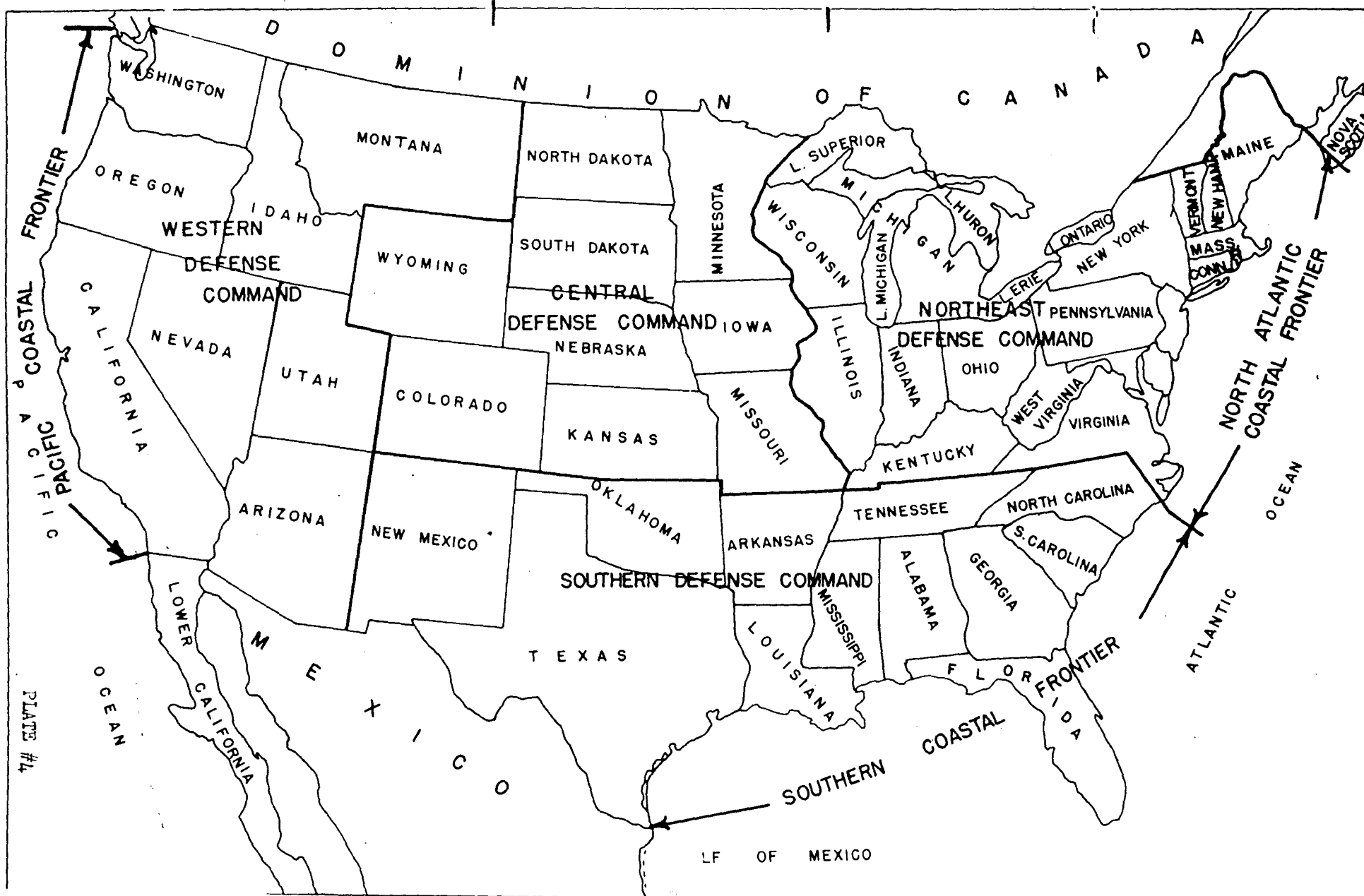

PLATE #4

15853

Committee constituting representatives of the First Army and the Third Naval District. The plan was to be for the area encompassed by the First, Second and Third Corps Area and therefore the First, Second and Third Artillery Districts.

Further Local Joint Planning Committees were directed to be constituted for each Frontier Defense Sector and each Base Command (Newfoundland). New York-Philadelphia Sector, Air Defense Region, First Corps Area and Naval Districts (Third and Fourth) were directed to be represented with members on the Local Joint Planning Committee.

This Local Joint Planning Committee for the "new" sector of 1941 held its first meeting at Fort Hamilton on March 20, 1941 and discussed the Northeastern Theater or First Army Plan, noting that the change in New York Sector was to add the Harbor Defenses of the Delaware and omit the Harbor Defenses of Long Island Sound but that no subsectors were mentioned in the new plan. This "NET" plan marked the departure from the "color" plans.

The Local Joint Planning Committee also designated the choice of locations for Harbor Entrance Control Posts at Fort Wadsworth for "Sandy Hook Subsector" (New York Subsector) and at "Henlopen" (Fort Miles) for the "Henlopen Subsector" (Philadelphia Subsector). Command post for the subsector HECPS were to be located at Fort Wadsworth and Fort Dupont respectively.

On March 29, 1941 the Second Coast Artillery District recommended a boundary of subsectors to coincide with the boundary between the Third and Fourth Naval Districts as advised by First Army. Subsequently, on April 17, 1941, First Army augmented its plan by the following designation of boundaries:

(Ref. 660.3/139 LJPC - 2nd CAD)

Within the New York-Philadelphia Frontier Defense Sector:

"New York Subsector:

"Northern boundary: Same as the boundary between New England and the

New York-Philadelphia Frontier Defense Sectors.

"Southern Boundary: Point Pleasant (Incl.) - BORDENTOWN (Excl.) - TRENTON (Incl.) - DELAWARE RIVER.

"Philadelphia Subsector:

"Northern Boundary: Same as the southern boundary of New York Subsector.

"Southern boundary: Same as the boundary between New York-Philadelphia and the Chesapeake Bay Frontier Defense Sectors."

The picture of Sector was now substantially what it remained until 1944.

(See plate No. 3)

Meanwhile, on March 17, 1941, the War Department again shifted the "Peace Organization of Field Forces of Continental United States which would, according to a letter of that date (Ref. 381/10 NET), "facilitate and clarify responsibility in defense planning ...."

Under this scheme the continental United States was divided into four strategic areas, each of which is designated a "Defense Command" as Northeast, Central, Southern and Western (See plate No. 4).

The Defense Command is defined as "a territorial agency with appropriate staff designed to coordinate prepare and to initiate the execution of all plans for the employment of Army Forces and installation in defense against enemy action in the portion of the United States lying within the command boundaries." Further:

"Present Air Districts are replaced by air forces ..... until otherwise directed, each Air Force will include all aviation and air installations that now form a part of the corresponding Air District as shown in parentheses below.

"For the purpose of defense organization and planning, primary responsibilities under the Commanding General, GHQ Air Force, are assigned to Air Forces as follows:

- "1st Air Force (NE Air Dist.) NE Defense Command.
- "2nd Air Force (NW Air Dist.) Central Defense Command.
- "3rd Air Force (SE Air Dist.) Southern Defense Command.
- "4th Air Force (SW Air Dist.) Western Defense Command.

\*NOTE - The Joint Plan for the New York-Philadelphia Sector was only approved for operation in an emergency by First Army because, as it was phrased in the approval of July 12, 1941, there were in preparation revised plans that would require a revision of the plan of defense for the North Eastern Theater to be issued in the near future. (Ref. 381/21 NET)

This peace time organization of the major elements of the field forces, to

(7)  
SECRET

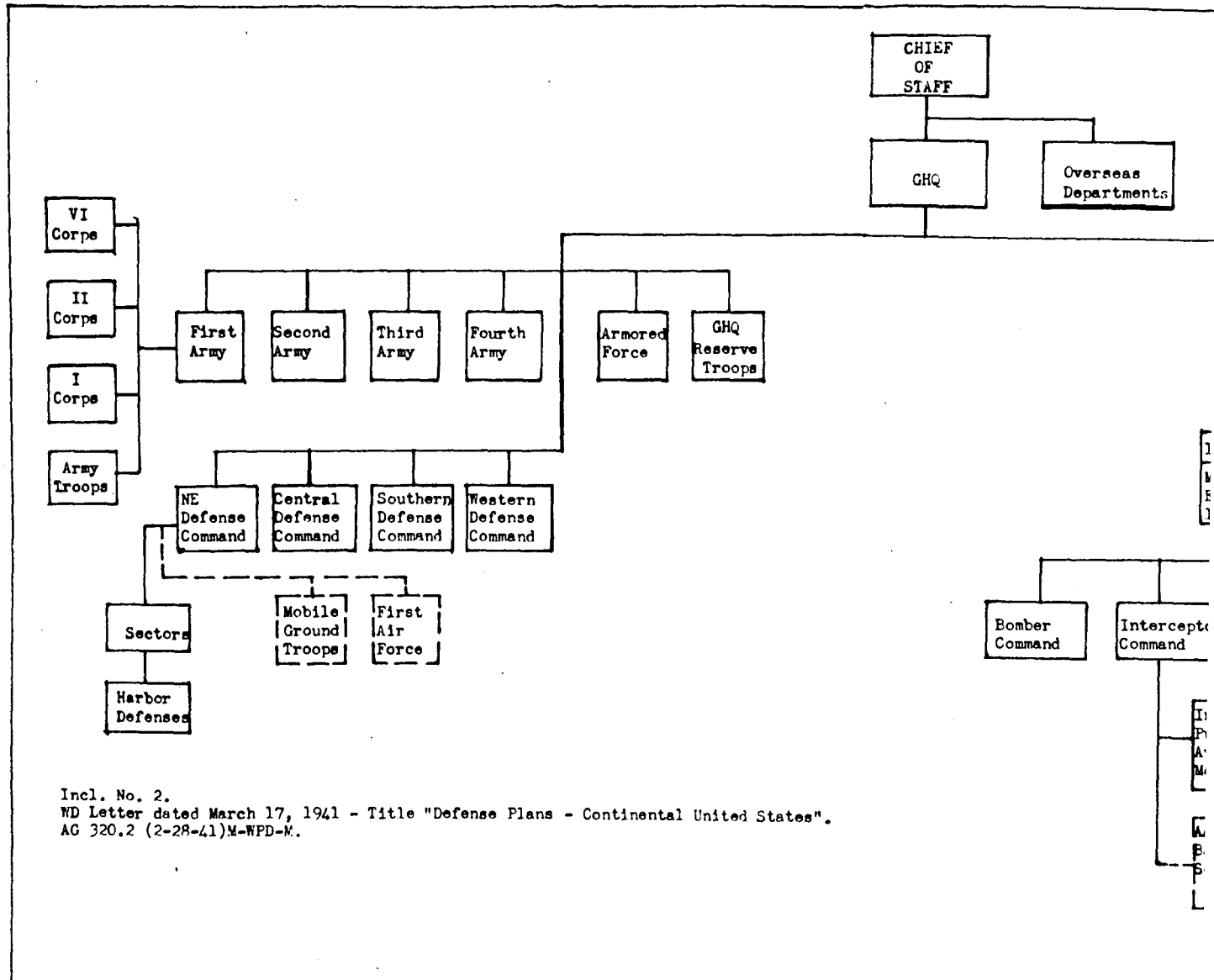

Incl. No. 2.  
 ND Letter dated March 17, 1941 - Title "Defense Plans - Continental United States".  
 AG 320.2 (2-28-41)M-WPD-M.

include these territorial commands is indicated in the graphical outline following. (See plate No. 5)

In stating responsibilities of command the letter read:

"The Commanding General, Defense Command, under GHQ, is responsible for the peace time planning for all measures of defense for that portion of the United States lying within the command boundaries. He is responsible for the local coordination of plans for the employment of all Army Forces with such plans of Naval Units. He is responsible in war for the execution of all defense operations until otherwise directed by the War Department."

"The Commanding General, GHQ Air Force, under GHQ, is responsible for the peace time organization and training for air operations and defense against air attack in the continental United States, except:

"Operation of aviation attached to ground units.

"operation of antiaircraft artillery assigned or attached to mobile ground units, and technical training of all antiaircraft artillery.

"Measures against low flying aircraft with organic means available to ground troops.

"Passive defense measures (except those pertaining to GHQ air force units and installations.)

"He is responsible for the preparation of the aviation and air defense portions of defense plans for Defense Commands."

Army Commanders were designated, in addition to their present duties as follows:

Commanding General, First Army also Commanding General, NE defense Command.

Commanding General, Second Army, also Commanding General Central Defense Command.

Commanding General, Third Army, also Commanding General Southern Defense Command.

Commanding General, Fourth Army, also Commanding General Western Defense Command.

Under this directive Corps Area Commanders retained their responsibilities in matters of domestic disturbances and passive measures for defense against air attack.

The representation of the GHQ Air Force on local joint planning committees was provided for by the designation to the commanding General of each defense command by the Commanding General GHQ Air Force, personnel for appointment as Army Members to these committees.

SECRET



It was also during this period of intensified planning for the activation of Harbor Defense troops of Harbor Defenses that were to be part of New York-Philadelphia Sector Command took place. The activations were in connection with the operation of the plan for the augmentation of the Army forces of 375,000. In compliance with a directive of the War Department, AGO, Headquarters Second Corps Area, issued General Orders No. 17 activating the following Coast Artillery units with designated permanent stations, effective 1 August 1940 as follows:

<u>UNIT</u>	<u>STATION</u>
Btry C, 7th CA (HD)	HD of Sandy Hook
Btry A, 21st CA (HD)	HD of Delaware
Btry A, 5th CA (HD)	HD of Southern New York

With General order No. 3, January 15, 1941, same headquarters, as changed by General Orders No. 3, February 12, 1941, the following units were activated at stations indicated on January 15, 1941 on authority of the Adjutant General's Office letter of December 16, 1940.

<u>UNIT</u>	<u>STATION</u>
Btrys. B & C, 21st CA (HD)	HD of Delaware
Hq. & Hq. Btry., 1st Bn, 7th CA (HD)	HD of Sandy Hook, N.J.
2nd Bn., 7th CA (HD)	HD of Sandy Hook, N.J.
Hq. & Hq. Btry., 2nd Bn, 52nd CA (Ry)	HD of Sandy Hook, N.J.
Btrys. B & D, 5th CA. (HD)	HD of Southern New York

The change of General Order No. 3, referred to above activated these elements of the 52nd CA (Ry) on January 8, 1941, stationed HD of Sandy Hook:

Hq. and Hq. Btry, 3rd Bn.	
Btry D	2nd Bn.
Btry F	3rd Bn.

On the authority of a letter from The Adjutant General, April 25, 1941, the following organizations were activated June 1, 1941 at Fort Hancock by General Order Number 15, Hq. 2nd Corps Area, May 22, 1941:

1st Bn., 52nd CA (RY)
Btry G (SL) 7th CA (HD)
151st Sta. Hosp.

The picture now was one of alertness for any sudden assault on the shores of the United States, with, at the same time, attention being devoted to intensive training of the expanding Army due to the operation of the Selective Service Act. Sectors had not been constituted as such and the Second Coast Artillery District still held command. General orders issued by this headquarters in the Summer of 1941 gives the best picture of the situation for what was to be "Sector", as seen by Staff strategists in this period.

When the President directed measures for the defense of the Western Hemisphere in the Spring of 1941, the Navy instituted certain measures that required the cooperation of the Army, and harbor defenses assumed condition three, omitting major caliber batteries. The order, General Order No. 1, Headquarters, Second Coast Artillery District, June 7, 1941, reads:

"1. By direction of the President, the Navy has instituted certain measures for the defense of the Western Hemisphere, and the Army forces have been ordered to cooperate in the execution of these measures, subject to the following:

a. Current training activities will be continued.

b. The navy retains responsibility for inshore and offshore patrols. No active reconnaissance measures by the Army are contemplated for the specific purpose of locating belligerent vessels or aircraft.

c. Under this directive Army forces will engage in combat only when necessary for their own protection, or for that of other United States military or naval forces, or for the prevention of attack on United States flag shipping by belligerents.

2. In order to carry out the above directive, the following steps will be taken with the least practicable delay:

a. Each harbor defense will assume Condition Three (TWL3, this headquarters, June 7, 1941) omitting major caliber batteries, and with no change in existing orders governing passes and furloughs for the present.

b. the 62nd Coast Artillery will continue current training, but will be ready to occupy positions for the defense of Brooklyn Navy Yard in conformity with existing plans when so directed.

c. Harbor entrance control posts will be prepared for continuous operation, and will be given frequent tests, but will not maintain continuous opera-

tion until further orders. The New York HECF will be operated by this headquarters, and the Philadelphia HECF by the Commanding Officer, Harbor Defenses of the Delaware.

d. Batteries will fire only upon orders of harbor defense commanders, who will assure themselves that combat engaged upon only when necessary for self protection, protection of other United States military or naval forces, or for the prevention of attack on United States flag shipping by belligerents.

e. In addition, all observers will be especially alert to detect, precisely locate and immediately report any evidence of mining operations by belligerents, either known or unidentified.

3. Harbor defense commanders will report as soon as the provisions for this order have been put into effect, giving the names of fixed seacoast batteries, the location and fields of fire of 155mm batteries, and the tactical numbers and location of fired AA gun batteries manned under the provisions of paragraph 2 a. above. Copies of all orders issued to carry out these orders will be inclosed with the reports, and subsequent changes will be likewise promptly reported.

4. Steps will be taken to expedite the placing in service of additional anti-aircraft batteries as soon as fire control equipment is received."

These orders were rescinded by General Orders No. 15, same headquarters, October 21, 1941, rephrasing the procedure for defense as follows:

"2. The following procedure will govern the action of forces comprising the New York-Philadelphia Sector in the execution of plans for the Defense of the Western Hemisphere:

a. Maintenance of each Harbor Defense in Condition Three SOP (TM No. 18, this Headquarters, June 7th, 1941) omitting major caliber batteries and with no change in existing orders governing the granting of passes and furloughs.

b. Maintenance of the 62d CA (AA) in a state of readiness to occupy positions for the defense of BROOKLYN NAVY YARD in conformity with existing plans, when so directed.

c. Maintenance of the New York Harbor Entrance Control Post and the Delaware Harbor Entrance Control Post on a training basis and prepared for operation on a war basis in conformity with letter AG 660.2 (9-13-41)MC-E, subject "Harbor Entrance Control Post", dated October 2nd, 1941.

d. Batteries will fire only upon orders of Harbor Defense Commanders who will assure themselves that combat is joined only when necessary for self-protection, protection of other United States military forces, or when hostile forces threaten United States and Iceland flag shipping.

NOTE: Hostile forces (surface war vessels, submarines or aircraft) will be deemed to threaten United States or Iceland flag shipping if they enter the WESTERN ATLANTIC AREA or United

States or Canadian Coastal Zones in the Atlantic and Caribbean.

3. Harbor Defense Commanders will make report, by the most expeditious means available, to this Headquarters when combat is joined under authority delegated in paragraph 2 d above."

Still another change was instituted a week later when General Order No. 16, same headquarters, directed that paragraph 2 d read:

"1. Batteries will fire only upon orders of Harbor Defense Commanders who will assure themselves that combat is joined only when necessary for:

- (1) Self-protection
- (2) Protection of other United States military forces.
- (3) Protection against hostile attack of United States and foreign flag shipping, other than German and Italian shipping."

In relation to these orders it must be remembered that at this time Anti-Aircraft Artillery was to be a part of the command of New York-Philadelphia Sector command when and if it operated.

It was in connection with this state of alertness that prompted these warning orders that Forrest E. Williford, then Commanding General, Second Coast Artillery District, called upon Col Rodney M. Smith, then commanding the 62nd CA (AA) to maintain his command in a state of instant readiness in a letter of a April 1941. Colonel Smith, at Fort Totten, was authorized to get into direct communication with the Commandant at Brooklyn Navy Yard for coordinated action.

Gen. Williford noted that the plan for the defense of the Northeastern Theater, assigned the 62nd CA (AA) to the New York-Philadelphia Sector commanded by the Commanding General, Second Coast Artillery District. Also the plan charges the 62nd CA (AA) with the antiaircraft defense of the Brooklyn Navy Yard. The supporting antiaircraft artillery in the New York Area was listed as:

- 1 battery (3 guns, fixed mount) at Fort Totten
- 1 battery (3 guns, fixed mount) at Fort Hamilton
- 1 battery (3 guns, fixed mount) at Fort Wadsworth
- 1 battery (3 guns, fixed mount) at Fort Tilden
- 1 battery (3 guns, fixed mount) at Fort Hancock

These batteries were described as being in various stages of modification, the battery at Ft. Tilden and the two batteries at Fort Hancock being in the most advanced stages of readiness for service".

One gun battery and one searchlight platoon of the regiment was on detached service in Newfoundland at the time Col. Smith described conditions preventing the 62nd CA (AA) from being put in a state of instant readiness in a letter of April 4, 1941. One was a shortage of armament allotted, lack of opportunity for target practice, the training of 93" selectees, (two thirds of the regiment) and the loss by the regiment of more than half its key men in a cadre transferred to Ft. Austin shortly before. Rather than abandon his training, Col. Smith advised against partial manning of armament by older men and wished to continue a balanced training plan.

In this Gen Williford concurred remarking that "instant readiness" did not refer to the immediate present and advised that "training advance promptly as scheduled".

An apparent conflict in missions for the 62nd CA (AA) was revealed in a letter of April 7th when Col. Smith wrote that Emergency Plan White also would require the action of the regiment as infantry for the defense of the Lower Hudson District, key New York Bridges, and the LaGuardia Airport in event of an emergency. First Army Headquarters stated its policy as follows in clarifying the apparent dual role.

".... The primary tactical function of the 62nd CA (AA) is to provide anti-aircraft protection for the Brooklyn Navy Yard and this duty, upon the outbreak of hostilities, takes precedence over all EPW missions. It is anticipated that EPW may become effective prior to the outbreak of hostilities."

This is the background. The war clouds were not to pass over but to burst into a storm on our shores, a storm that fulfilled the promise of the darkness of the clouds. Sector was in the forge and the heroic blood that ran at Pearl Harbor was to quench the steel of the blade.

SECTION II

SECTOR IN OPERATION

SECRET

SECTION II

(Part 1)

GENERAL

SECRET

The plan for operation as the New York-Philadelphia Frontier Defense Sector was put into effect December 10, 1941, when instructions from Headquarters, First Army were disseminated by radio. Under these instructions the designation, 2nd Coast Artillery District was changed to New York-Philadelphia Frontier Defense Sector, with headquarters at Fort Hamilton, N.Y., and the personnel of the 2nd Coast Artillery District manned the Sector with Brig. Gen. Arthur G. Campbell commanding.

This action was followed by written instructions issued by the 2nd Coast Artillery District in a letter of December 11, 1941, sent to the harbor defenses by command of Brigadier General Campbell. (Ref. 381/31 GEN) it read:

1. The following confirms and amplifies previous instructions.
2. The New York-Philadelphia Sector is activated.
3. Assume Condition Two SOP. Germany, Italy and Japan are hostile.
4. Place in effect such provisions of DPJNYP 41 as apply to following tasks with forces now under your command. Supporting 28th Division has been informed plan is in effect but no troop movements will be made until authorized by First Army.
5. Establish and operate subsectors as prescribed in DPJNYP 41 except that command will be exercised from Harbor Defenses of Sandy Hook and Delaware. Report when established.
6. Supported by Navy and First Air Force defend your subsector against attack by land, sea and air, in Category B.
7. Support the Navy in the protection of friendly sea communications and in destruction of enemy forces within your radius of action.
8. In cooperation with Navy execute underwater harbor defense measures. Navy will establish patrols and issue warning to shipping, but mines will be planted in New York approaches only. Report progress by wire daily.
9. Continue in effect all cooperation measures with Navy in carrying out their Defense Plan Number Five.

The following subordinate units were activated by General Orders #1, New York-Philadelphia Frontier Defense Sector:

New York Frontier Defense Subsector - C.P. Fort Hancock, N.Y. composed of:

The Harbor Defenses of Sandy Hook, Fort Hancock, N.J.  
The Harbor Defenses of Southern New York, Fort Hamilton, N.Y., and the Harbor Defenses of Eastern New York, Fort Totten, New York.

Philadelphia Frontier Defense Subsector - C.P. Fort DuPont, Delaware, composed of:

The Harbor Defenses of the Delaware, Fort DuPont Delaware.

SECRET



Actually however although the 2nd Coast Artillery District was operating under the Joint Action Plan, The District officially remained as such until the War Department orders of March 1, 1942 created the New York-Philadelphia Frontier Defense Sector. Brigadier General Campbell was commander of the 2nd Coast Artillery District on War Department orders since November 29, 1941, and orders were in process of being distributed calling General Haines to command of the 2nd Coast Artillery District from his post as Harbor Defense commander of Narragansett Bay, Fort Adams, Rhode Island. Before this was accomplished the 2nd Coast Artillery District had become in fact the New York-Philadelphia Defense Sector and Brig. Gen. R.E. Haines set up his command under the provisions of the Joint Action of the Army and Navy and the Joint Army Navy Plan for the Defenses of the New York-Philadelphia Frontier Sector.

General Campbell took over General Haines former command at Fort Adams.

Special Orders #1, dated January 2, 1942, created New York-Philadelphia

Frontier Defense Sector named General Haines Staff as follows:

- Sector Commander. General RALPH E. HAINES, O-2891, USA
- Executive. Colonel EARL BISCOE, O-1674, CAC
- Aide-de-Camp 1st Lt. WILLIAM F. MADISON, O-361426, CAC
- Morale Officer and Public Relations Officer
- Plans & Projects Officer Lt. Col. ALBERT M. JACKSON, O-5854, CAC
- S-1 & Adjutant General Captain BENITO MORALES, O-301225, AGD
- S-2 & Naval Liaison Officer Captain JOHN M. PHILLIPS, O-298606, Inf.
- S-3 & Antitank Officer Major PAUL A. JACCARD, O-16694, CAC
- Assistant S-3, and Assistant Antitank Officer Major JOHN S. MAYER, O-217175, CAC
- Assistant S-3, and Cryptographer 2nd Lt. EDWARD T. CAMPBELL, O-385886, CAC
- S-4 and Cryptographic Security Officer Major CHARLES CRANE, O-163576, CAC
- Assistant S-4 Captain JAMES C. O'CONNOR, O-288947, CAC
- Communications Officer 1st Lt. JOHN G. AUSTIN, O-343959, CAC
- Property Officer,
- Engineer Officer and
- Cryptographer

Classification Officer,  
Actg. Asst. Adjutant General,  
Asst. S-1., & C.O. Hq. Co.

2nd Lt. EVERETT H. DAVEY, O-390819, CAC.

Inspector General

Colonel SAMUEL J. TAYLOR, O-145463, IGD.

Judge Advocate General

Major FREDERICK H. HAUSER, O-311304, JAGD

D.S. First Army Provisional  
Antiaircraft Command, Fort  
Totten, New York

Colonel AVERY J. FRENCH, O-3210, CAC

The organization of command under this initial was Plan was as pictured on plate No. 6.

This plan, prepared in accordance with the DP-NET-41, was approved by the Commanding General, First Army ... "for operations in emergencies, pending the preparation of revised plans on July 12, 1942 and did not have War Department approval. It was signed by Forrest E. Williford, Brigadier General, U.S. Army, commanding the 2nd Coast Artillery District.

The emergency arrived with Pearl Harbor and on December 10, 1941 Lieutenant General Hugh A. Drum, U.S. Army, Commanding General, First Army, said "this is the plan."

The forces to be available to the New York-Philadelphia Sector under this plan were:

Hq. and Hq. Battery Second Coast Artillery District  
U.S.A.M.B. "Ord"  
U.S.A.M.P. "Henry" (cable ship)  
52nd C.A. (RY)  
28th Division (square)  
Two battalions C.A. (TD) (155mm gun)  
New York Subsector  
Philadelphia Subsector

For the New York Subsector:

Harbor Defenses of Eastern New York  
Harbor Defenses of Southern New York

Hq. and Hq. Det.  
5th C.A. (HD Type A)

Harbor Defenses of Sandy Hook

Hq. and Hq. Btry.  
7th CA (HD Type B)

245th C.A. (HD Type C)

SECRET  
(16)

34th C.A. Brigade (AA)  
 Hq. and Hq. Btry  
 67th C.A. (AA)  
 76th C.A. (AA)  
 77th C.A. (AA)  
 62nd C.A. (AA) attached  
 93rd C.A. (AA) (semi-mobile) attached  
 94th C.A. (AA) (semi-mobile) attached  
 95th C.A. (AA) (semi-mobile) attached  
 96th C.A. (AA) (semi-mobile) attached

For the Philadelphia Subsector:  
 Hq. and Hq. Det. Philadelphia Subsector  
 Harbor Defenses of the Delaware  
 Hq. and Hq. Btry  
 21st C.A. (HD Type B)  
 261st C.A. (HD Separate Battalion Type D)

38th C.A. Brigade (AA)  
 Hq. and Hq. Btry  
 70th C.A. (AA)  
 213th C.A. (AA)  
 214th C.A. (AA)  
 97th C.A. (AA) (semi-mobile) attached  
 122nd C.A. (AA) (Sep. Bn guns) attached

In addition the Navy supplied vessels for Inshore and Offshore patrols and net and boom defenses under mutual support plans.

In order to coordinate the efforts of Army and Navy, Harbor Entrance Control Posts were to be maintained at Fort Wadsworth, with Navy Liaison Officers at Forts Hancock and Tilden, for the New York Subsector, and at Cape Henlopen for the Philadelphia Subsector.

It was planned that the 28th Division would organize three combat teams consisting of 1 infantry regiment and 1 field artillery battalion and move to Fort Dix, N.J. at once, ... Initial garrisons under subsector commanders control were to be, 1 infantry Battalion (rifle) with 1 Battery Field Artillery (105 mm howitzer) and 1 Company attached each at Camp Upton, Long Island, N.Y.; Collingwood, Park, N.J. and Georgetown, Del.

A battalion of the mobile 155's was to be attached to the New York Subsector; another Battalion, less one battery, was to be attached to the

HQ NORTHEASTERN THEATER  
HQ FIRST ARMY

NEW ENGLAND  
FRONTIER DEFENSE SECTOR

NEW YORK - PHILADELPHIA  
FRONTIER DEFENSE SECTOR

CHESAPEAKE BAY  
FRONTIER DEFENSE SECTOR

NEW YORK  
SUB - SECTOR

U.S.A.K.F.  
ORD

MOBILE  
RESERVE

U.S.A.K.F.  
HENRY

PHILADELPHIA  
SUB - SECTOR

HD EASTERN  
NEW YORK

HD SOUTHERN  
NEW YORK

HD  
SANDY HOOK

BEACH  
FORCES

NY AREA  
AA DEFENSE

FT. TOTTEN

FT. HAMILTON

FT. WADSWORTH

FT. HANCOCK

FT. TILDEN

HD  
DELAWARE

BEACH  
FORCES

PHILA. AREA  
AA DEFENSE

FT. DU FONT

FT. SAULSBURY

FT. DELAWARE

HENLOPEN

FT. MOTT

CAPE MAY

SECRET

SECRET

ARMY  
ORGANIZATION OF COMMAND  
NEW YORK - PHILADELPHIA  
FRONTIER DEFENSE SECTOR  
1961

PLATE #6

17

28th Division, and a mobile 155 battery was to be attached to the Philadelphia subsector. The 52nd C.A. (RY) (less 1 Btry.) was to remain at Fort Hancock under Sector control in a state of readiness to support the defense against landing operations in the New York-Philadelphia Sector.

These forces were given the following missions:

To maintain a close surveillance of all beaches within the area to which assigned.

To resist hostile landing operations in the Sector areas.

To resist hostile action in the Defense Coastal Areas.

To provide antiaircraft artillery protection.

To establish liaison with all elements of command, the Navy elements and the adjacent elements of flanking sectors.

The operation of the wheels for war were set in motion in the order sent to Harbor Defenses of the New York Area and the Harbor Defenses of the Delaware to "assume Condition Two."

Then on December 15, 1941, the Northeastern Defense Command, as the Northeastern Theater was then known, advised all units of command that the North Atlantic Coastal Frontier was assuming Defense Category C. This changed the category of defense designated in the "Sector" letter of instructions of December 11, which assumed Defense Category B.

Within a day of Pearl Harbor the anti-aircraft artillery units had been thrown into action by movement orders from Headquarters, First Army, dated 8 December, 1941. These movement orders distributed Coast Artillery units for the defense of the northeastern United States from attack by enemy aircraft. That part of those movements that included the area to be encompassed by New York-Philadelphia Sector were as follows:

"The 67th Coast Artillery Regiment (AA) from Fort Bragg, N.C, to defense of Mitchel Field, Long Island, New York.

(18)

SECRET

"The 61st Coast Artillery Regiment (AA), Fort Sheridan, Illinois; the 197th Coast Artillery Regiment (AA), Camp Hulen, Texas; the 213th Coast Artillery Regiment (AA), Camp Stewart, Georgia and the 62nd Coast Artillery Regiment (AA), Fort Totten, New York, from stations indicated to defense of the New York Area. The Commanding General, with Headquarters and Headquarters Battery 38th Coast Artillery Brigade (AA), Camp Stewart, Georgia, will assume command of the groupment.

"The 67th Coast Artillery Regiment (AA), Fort Bragg, North Carolina to defense of Philadelphia Area.

"The 77th Coast Artillery Regiment (AA), Fort Bragg, North Carolina, to defense of Wilmington, Delaware, Area."

The orders directed these regiments, and others, to "move at once upon receipt of these orders." Leaves and furloughs were cancelled. (Ref. 370.05/20)

Although these Antiaircraft commands were included in the NET plan for New York-Philadelphia Sector they were soon to be removed and placed in a separate Air Command under control of Eastern Theater of Operations, and later Eastern Defense Command, and First Army as will be seen in following pages.

Another of the first moves upon outbreak of hostilities was to throw into action the Regimental Combat Team that was to fill the coastal gaps between Harbor Defenses for Sector. The organizations that were to supply these troops had been shifting due to reassignment of troops in the National picture.

In a letter from Headquarters, 2nd Coast Artillery District to the 12th Infantry, September 16, 1941 (Ref. 381/26) it was stated that during the absence of the 28th Division on maneuvers the Sector Mobile Reserve would consist of the 12th Infantry and the 372nd Infantry and such other units as are both suitable and available.

This marked the disappearance of the 28th Division from the Sector picture since a letter from Headquarters, First Army, December 11, 1941 (Ref. 381/32) noted in a paragraph 4 that "the 44th Division is substituted

SECRET

for the 28th Division as mobile reinforcements for the New York-Philadelphia Frontier Defense Sector .....

The following day, December 12, 1941 the Headquarters, First Army in movement order 504 (Ref. 350.05/23) directed the Commanding General, II Army Corps, Wilmington, Del., to order the movement of one Infantry Battalion(rifle) reinforced by one field artillery battery (105mm how.) and one engineer's company (combat) all from the 44th Division to proceed without delay from Fort Dix to Mitchell Field, N.Y., "reporting on arrival to the Commanding General, the New York-Philadelphia Frontier Sector (Commanding General 2nd Coast Artillery District, Fort Hamilton, N.Y.) for duty."

Another movement order, 505, dated December 16, 1941 from Headquarters First Army (Ref. 350.05/29) directed the II Army Corps to supply troops for attachment of Sector as follows:

Move one Battalion Combat Team from 113th Infantry to concealed bivouacs in the vicinity of Georgetown, Del. and the 113th, less detachments, with one battery of light field artillery and one Company of combat engineers attached, to concealed bivouacs in the vicinity of Freehold, N.J. for temporary, "reporting on arrival to the Commanding General, New York-Philadelphia Defense Sector, Fort Hamilton, N.Y.

Subsequently, in Special Orders 295, 44th Division, Fort Dix, N.J., dated December 18, 1941, the 2nd Battalion, 113th Infantry (Mtd) with 2nd Battalion communications Sections and Medical Section, 113th Infantry; Battery C, 156th Field Artillery; Company A, 104th Engineers; Second Platoon, Company A, 119th Quartermaster Regiment, with two additional trucks and drivers, and one ambulance, 119th Medical Regiment attached, was ordered to proceed without delay ..... to vicinity of Georgetown, Del. .... (U)

SECRET

The use of these mobile forces as prescribed by the category of defense in effect was outlined in a contemporary directive issued by the Northeast Defense Command as follows:

"The Mobile Forces allotted to Sectors are for the primary purpose of defense against landing operations by establishing outposts, outside the Harbor Defenses, covering the likely landing areas, and patrolling between such outposts and the harbor defenses themselves. They will not be assigned to the local defenses of nor as reinforcements for Harbor Defenses except in emergencies." (Ref. 370.05/37).

The best picture of the distribution of these forces is found in the S-4 report of housing dated December 20, 1941. (Ref. 370.05/41). It showed:

At Cape May - Detached Company, Second Battalion, and detachments Machine Gun Company and Anti Tank Company quartered in buildings owned by Lower Township, Cape May County.

Vicinity of Georgetown - Second Battalion less detached Company in old CCC Camp. Engineer Company, Field Artillery Battery in old buildings while infantry in pyramidal tents.

Eatontown - Third Battalion and Regimental Headquarters in pyramidal tents on private property of the Monmouth Ice Company.

Mitchell Field - First Battalion, less detached Company and one Field Artillery Platoon in winterized tents at Old Camp Mills.

Camp Upton, N.Y. - one detached infantry company, First Battalion in existing quarters.

Fort Hancock, N.J. - Regimental Headquarters Company and Anti-tank Company, 113th Infantry.

A subsequent report on housing, February 5, 1942 advised that winterizing of all tents were completed.

With the employment of the Infantry Combat Team on of the awkward problems of territorial division of command is brought to our attention. It was the problem of the division of responsibility on the northern boundary of the New York-Philadelphia Sector where the defense of Long Island was divided at Shinnecock Light by the boundary between sectors. The water area to the east was assigned to the New England Sector as a part of the Harbor Defenses of Narragansett



since the armament on Montauk Point the island forts and shore batteries constitute a tactical entity for the seaward defense of Narragansett and the eastern entrance to Long Island Sound.

However when the question beach defense arose a different problem was posed. Originally a temporary agreement was reached in which, on Dec. 13, 1931, the North-east Defense Command directed that, pending availability of mobile forces to the Commanding General of the New England Frontier Defense Sector, the Commanding General of the New York-Philadelphia Frontier Defense Sector would be responsible for the mobile defense of Long Island "without regard to the boundary between Frontier Defense Sectors.

\* NOTE - It is interesting that the geography of the area divided by the boundaries of New England and New York-Philadelphia Sectors posed a question of long standing. The problem came to a question of decision in 1934 and the statement of advantages made at that time in a memorandum of Headquarters, Second Corps area, Brigadier W. E. Cole, commanding, dated January 15, 1934 would better lead to the understanding of the reason for Sector boundary on the north. The memorandum reads:

The former boundary between Corps Areas, in effect prior to February 24, 1931, placed the responsibility for the defense of Connecticut and that part of the State of New York east of Longitude 72 30' on the New England Sector. The present (January, 1934) boundary between the New England and New York Sectors coincides with the boundary between the First and Third Naval Districts, ..... The advantages of disadvantages of changing the boundary back to where it was prior to February 24, 1931, are as follows: (Ref. para. a and b 660.3 LFC 2nd CA /29)

"Advantages: The proposed armament of the three Harbor Defenses of the Narragansett Bay Area, Namely the Harbor Defenses of New Bedford, Narragansett Bay, and Long Island Sound, are interlocking in that the long-range armament of all three bears on the sea area, Montauk - Buzzards Bay (See Exhibit "A"). The fire of the batteries located in the above-named Harbor Defenses overlap and their concentrated action is necessary in forbidding access by the enemy into this area, and insuring free passage of our own Navy in and out of the area. Observation from Block Island can control the fire of the batteries in all three of these Harbor Defenses as indicated on Exhibit "A", and the fire control system based in Block Island should be made an integral part of the fire control system of all three of these Harbor Defenses. In addition, Connecticut remains a part of the First Corps Area for mobilization, but with the present boundary between Sectors, its coastal frontier becomes a part of the Second Corps Area for Defense. This obviously is unsound in principal.

"Disadvantages: Forts H. G. Wright, Michie, and Terry, and Montauk Point are geographically located in the State of New York, and normally would be under

the jurisdiction of the Second Corps Area. In Addition, a landing on the Eastern Area of Long Island in the vicinity of Montauk Point immediately becomes a problem for the Commandant of the New York Sector, however, the probabilities of a landing in force in this area is small, due to the narrow peninsula between Peconic Bay and Shinnecock Bay. Moreover, the present boundary coincides with the boundary between the 1st and 3rd Naval Districts, however, the Commandant of the 1st Naval District states that this is not a serious consideration."

The Commandant of the Third Naval District, Rear Admiral Yates Stirling, Jr., expressed his views in a somewhat different light in a letter on March 15, 1934, addressed to the Headquarters, Second Corps Area, as follows:

"The Commandant, Third Naval District appreciates the advantages from the Army point of view, of having the Coast Defenses of the Narragansett Bay Area in the same Corps Area.

"From a naval point of view this area is of primary interest to the Third Naval District rather than the First for strategical reasons, and it is not believed desirable to change the present limits of the Third Naval District to the westward.

"It therefore seems preferable to have this area under the Second Corps or at least such part of it as is now in the limits of the Third Naval District. This is the present arrangement. The defenses of Long Island Sound as far as Point Judith, and on the eastern end of Long Island, are easily accessible from New York, and in case of war, there would be less danger of their communications with the Second Corps Area Headquarters being cut than with the First Corps Area.

"It seems most logical that the defense of New York should be concentrated under one head, which would naturally be located in New York or its vicinity. From the standpoints of both the Army and the Navy, both sea entrances to New York are vital to the safety of the city, and the Army and Navy should coordinate in their defense. It would be most unwise to divide the defenses between Corps Areas.

The New York-Philadelphia Frontier Sector was directed to utilize the reinforced Infantry Battalion at Mitchel Field and Sector assigned an Infantry Company to the vicinity of Yaphank, L.I. for this purpose.

But even when mobile forces were available it was decided that the operation of the mobile defense of the eastern end of Long Island by the New England Sector was not desirable "due to the difficulty of reinforcement and of proper control" Therefore, on April 7, 1942, the now Eastern Defense Command ordered the relief of Company B, 101st Infantry, then stationed at Riverhead, L.I. by troops "presently available to the Commanding General, New York-Philadelphia Sector". Company B

was to be at the disposition of New England Sector. This called for a redistribution of forces of the 1st Battalion of Sector's combat team by New York Subsector.

This redistribution was made on the basis of two forces of approximately 180 men and three officers at Riverhead and Camp Mills with the bulk of the battalion strength being held at Camp Upton. The relief of Company B, 101st Infantry was accomplished 0700 April 13, 1942 by Company B, 113th Infantry (with 1 platoon, H.W. Company attached). Since that time the defense of Long Island has been under the control of Sector except for that section of the beaches within the confines of Camp Hero on Montauk Point. At a later date a Battalion of the 101st Infantry reinforced the 113th Infantry on Long Island but it was attached to NYPS as will be pointed out in later pages.

Shortly after the outbreak of hostilities, On December 23, 1941, a report on the assignment of Coast Artillery Batteries to armament read like this:

Unit	Name of Battery	Armament	Add. assignment AA - Type, Cal.
HARBOR DEFENSES OF NEW YORK AREA			
Harbor defense of Sandy Hook, Fort Hancock, N.J.....			
Btry. A, 7th CA	-----	Mines	
" B "	-----	Mines	
" C "	Morris	3" Barbette	3" AA
" D "	Fergusson (Tilden)	6" Barbette	.30 cal. MG
" E "	Kessler	6" "	3" AA
" F "	AA No. 3	3" AA	
" G "	-----	Searchlights	.50 cal. MG
" A, 245th CA	AA No. 1	3" AA	
" B "	AA No. 2	3" AA	
" C "	Urston	3" Barbette	Searchlights
" D "	Richardson	12" DC	3" AA
" E "	Mills	12" Barbette	37 mm AA
" F "	Kingman	12" Barbette	2 "
" G "	Harris (Tilden)	16" Barbette	"
" H "	Harris	16" Barbette	"
" I "	Kessler (Tilden)	6" Barbette	.30 cal. MG
" K "	Peck	6" Barbette	"
" L "	Gunnison	6" DC	"
" M "	Bloemfield	12" DC	3" AA
SLT. Btry.	-----	Searchlights	.50 cal. MG
Btry. C 52nd CA	8" Ry. No. 3	8" Ry.	.30 cal. MG

Harbor Defenses of Southern New York, Fort Hamilton, N.Y.			
Hq. Btry. 5th CA.	-----		Searchlights
Btry. A	"	-----	Mines
Btry. B	"	Dix (Wadsworth)	12" DC                      3" AA
		Livingston	6" DC                        3" AA

NOTES: - Personnel from batteries A and B were attached to Headquarters Battery for manning searchlights. Personnel from Battery B also furnished manning details for batteries Turnbull and Catlin, each 6-3" SC guns during emergency only. Personnel from Battery D also furnished manning details for Battery Griffin, 2-3" SC guns during emergency only.

Harbor Defenses of Eastern New York, Fort Totten, N.Y.		
Btry. E, 7th CA.	Burns	3" RF

Harbor Defenses of the Delaware, Fort DuPont, Del.		
Btry. A, 21st CA.	-----	Mines
Btry. B, 21st CA.	-----	Mines
Btry. C, 21st CA.	Btry #5	155 mm
Btry. A, 261st CA.	Btry #2	155 mm
Btry. B, 261st CA.	Btry #6 (Hall)	12" BC
Btry. C, 261st CA.	Btry #2	2-155 mm
	Btry #2	2-155 mm

An idea of the condition of Harbor Defenses in the New York-Philadelphia Sector is found in the S-4 report of July 1, 1941, slightly more than five months before the attack on Pearl Harbor.

At Fort Totten, then Harbor Defenses of Eastern New York, there was no command post, the only command features available being two wooden towers without fixtures of any kind. The armament ready for services consisted of batteries Baker and Burns, 3-inch (BC) batteries of two guns each. Three seacoast searchlights were also ready for service but the AA battery consisting of three 3" guns were not due to the lack of director, height finder, sound locators and searchlights. Four hundred rounds of ammunition were on hand for Baker and Burns but no ammunition was on hand for the AA battery.

The Harbor Defenses of Southern New York had group command posts and fire control stations all serviceable but with no splinter proof protection. The defenses included Forts Hamilton and Wadsworth and the submarine cable under

The Narrows had only a few circuits working. New cable had been ordered but not received. Radio facilities consisted of type 281 marine radio telephone sets.

Nine batteries were listed as ready for service but a note that followed the listing warned that the guns had not been fired for twenty-two years. The batteries, caliber and type, with the amount of ammunition on hand was designated as follows:

At Wadsworth: Battery Dix, 2-12" DC, 420 rounds; Battery Mills, 1-6" DC, 300 rounds; Battery Catlin, 6-3" BC, 1201 rounds; Battery Turnbull, 6-3" BC, 701 rounds.

At Hamilton: Battery Doubleday, 2-12" DC, 240 rounds; Battery Brown, 2-12" DC, 240 rounds; Battery Livingston, 2-6" BC, 339 rounds (manned 24 hours per day); Battery Johnston, 2-6" DC, 491 rounds; Battery Griffin, 2-3" BC, 336 rounds.

The AA defense consisted of two batteries of 3-3" fixed guns of three guns each but fire control installations were not complete and the armament was short two directors and one height finder, and eight searchlights, there were no ammunition, field wire or telephones. Two seacoast searchlights were ready for service. One portable was ready for service at Norton Point and two other portables were on hand and ready.

The mine command was short a planter and DB boat. The Coast Guard Cutter "Spruce" was to be available on "two days notice after August 1, 1941" as an emergency planter. It was estimated that the mine field could be planted in one week.

A mobile battery of four 155mm guns at Wadsworth was not ready for service having no ammunition, no field wire or telephones.

The Harbor Defenses of Sandy Hook had group command posts, fire control switchboards and fire control stations all ready for service although the efficiency of fire control was limited since Elberon, Short Beach and Zach's Bay towers were still incomplete. Radio stations were ready for service at both Forts Hancock and Tilden. Met. and Tide stations were serviceable at Hancock. The

armament ready for service with the ammunition on hand was as follows:

At Hancock: Battery Kingman, 2-12" BC, 600 rounds; Battery Mills, 2-12" BC, 600 rounds; Battery Richardson, 2-12" DC, 399 rounds; Battery Bloomfield, 2-12" DC, 399 rounds; Battery Gunnison, 2-6" DC, 600 rounds; Battery Peck, 2-6" BC, 1200 rounds (manned 24 hours per day); Battery Urmston, 2-3" BC, 100 rounds; Battery Morris, 4-3" BC, 1164 rounds.

At Tilden: Battery Harris, 2-16" BC, 400 rounds; Battery Fergusson, 2-6" BC, 400 rounds; Battery Lessler, 2-6" BC, 400 rounds (manned 24 hours per day).

The armament in service also included three mobile batteries of 4-155mm guns each, two at Fort Hancock and one at Fort Tilden. Each Battery was supplied with 400 rounds of ammunition.

The armament not ready for service included Battery Alexander, 2-12" DC; Battery Granger, 2-10" DC; Battery Halleck, 2-10" DC. Batteries Alexander and Halleck lacked ammunition, plotting equipment and fire control equipment. Granger had everything but ammunition.

The antiaircraft defense included three 3" batteries of three guns each, numbers 1 and 2 at Hancock and 3 at Tilden. Hancock had 698 rounds of ammunition while Tilden had 500 rounds. The batteries lacked directors and heights finders but were listed "ready for service" with battery 2 "ready to fire". There were two AA searchlights at Hancock and two sound locators. None at Tilden.

Two portable and one mobile (Ry) and four seacoast searchlights were ready for service at Hancock. Two new seacoast lights awaited installation at Fort Tilden which two portables set up on the beach.

The mine field was ready for planting but lacked shore installations at Fort Tilden. Shortages were a planter, two DB boats and two yawls.

The Harbor Defenses of the Delaware were suffering from "moving day" in addition to the other ills of defense facilities that had been "starved" for years. Group command posts and fire control stations were improvised due to the change in locations of the armament. There were no fire control instruments for any batteries except Elder, Hentig and Arnold. Telephone communications were largely dependent on the public telephone system. Radio facilities consisted of one No. 132 set for the Corps Area net supplemented by type 281 marine radio telephones. Field wire and field telephones to establish communications had been requisitioned but not received.

At Fort DuPont, Battery Elder, 2-3" BC guns with 260 rounds of ammunition.

was in service and manned 24 hours per day. A mobile battery of 2-155mm guns there was not in service, lacking ammunition.

At Fort Delaware Battery Hentig, 2-3" EC guns was ready for service with 360 rounds of ammunition.

At Fort Mott Battery Arnold's 2-12" DC guns were ready for service with 270 rounds of ammunition.

At Cape Henlopen (Fort Miles) two batteries of 4-155mm guns were ready for service with 600 rounds of ammunition. One of them was manned 24 hours per day.

At Cape May the mobile battery of 4-155mm guns were ready for service with 200 rounds of ammunition.

At Fort Saulsbury batteries Hall and Haslet, both 12" EC batteries of two guns each, were out of service. Haslet, which was scheduled to be shipped out to Cape Henlopen, had no ammunition while Hall had 540 rounds but no fire control stations.

Forts DuPont and Delaware each had a fixed searchlight ready for action and the 122d separate CA Bn (AA) had fifteen portables that could be used for seacoast work. The 122d (one battery of 4-3" AA guns), also furnished the entire AA defense for the Harbor Defense.

The mine command was short two planters, two DB boats, two yawls and casemate installation at Cape Henlopen. The only DB boat (L-56) was in poor condition and TNT was not available.

But the situation concerning the condition of armament, as well as strength of forces and plans for coastal defense, was changing rapidly. The declarations of war had found the coastal defenses in the process of modernization. This "Modernization Program of the Harbor Defenses of Continental United States" to meet the new threat to American shores had been approved only slightly more than a year before the involvement of the United States in World War II. It was approved by the Secretary of War, September 5, 1940 and outlined in a letter from the Adjutant General's Office in a letter of September 27, 1940.

(Ref. Mod. Fill) The program appeared like this:

Ref. TAG letter To CG  
2nd Corps Area  
Sept.27,'40 (660.2)

In the Second Corps Area the plan called for new 16-inch and 6-inch gun batteries, and the providing of existing batteries with overhead coverage.

all of the current project seacoast batteries with the exception of Battery Arnold at Fort Mott, on the Delaware river, were to remain in the project until the completion of the new batteries, 16-inch and 6-inch. It was directed that Battery Arnold be abandoned at once.

Other current project batteries, classified outmoded, were scheduled to be abandoned later.

Underwater defenses were not modified but some changes in current projects for rapid fire batteries that were to cover them, were directed.

A letter from the Adjutant General putting the modernization program in operation called for the naming of site boards to select the sites for the designated new batteries and in a special Second Corps Area order, No. 241, October 10, 1940, General Drum named the following.

Harbor Defenses of Southern New York - Colonel Avery J. Cooper, Coast Artillery Corps; Colonel Charles L. Hall, Corps of Engineers; Lieutenant Colonel Ernest R. Barrows, Coast Artillery Corps.

Harbor Defenses of Sandy Hook - Colonel Cooper, Hall and Colonel Forrest E. Williford, Coast Artillery Corps.

Harbor Defenses of the Delaware - Colonel Cooper, Major Harry B. Vaughn, Jr., Corps of Engineers, and Major Paul A. Harris, Coast Artillery Corps.

These site boards were to cooperate with local planning boards in that after the site board proceeding were approved by the Secretary of War they were to be given to the local board for the execution of details. In the end the proceedings were to appear as revisions of annexes of harbor defense projects.

The members of the local boards to parallel the action of the site boards were named in special order, No. 247, October 17, 1940, by the Second Corps Area as follows.



Harbor Defenses of Southern New York - Colonel Earl Biscoe, Coast Artillery Corps; Colonel Charles L. Hall, Corps of Engineers, Colonel Lucian B. Moody, Ordnance Department; Colonel Frank P. Lahm, Air Corps; Colonel John C. Moore, Signal Corps; Lieutenant Colonel Ernest R. Barrows, coast Artillery Corps; Lieutenant Colonel Leigh F. J. Zerbee, Chemical Warfare Service.

Harbor Defenses of Sandy Hook - Colonel Biscoe; Colonel Forrest E. Williford, Coast Artillery Corps; Colonel Hall, Colonel Moody; Colonel Lahm; Colonel Moore, and Lieutenant Colonel Zerbee.

Harbor Defenses of the Delaware - Colonel Biscoe, Colonel Moody, Colonel Lahm, Colonel Moore, Lieutenant Colonel James C. Hubson, Coast Artillery Corps; Lieutenant Colonel Zerbee and Major Harry B. Vaughan, jr., Corps of Engineers.

No provision was made for the Harbor Defense of Eastern New York as such. The modernization is examined and it is found that at Fort Totten the only work scheduled was for overhead shields on the 3-inch guns of batteries Baker and Burns.

In the Harbor Defenses of Southern New York Battery Livingston, two 6-inch BC, guns, and Battery Griffin, two 3-inch, BC guns were to get shields. Batteries Doubleday and Harvey Brown, both two-gun batteries of 12-inch, DC, guns were to be abandoned after completion of the program as was Battery Johnson with its two 6-inch, DC, guns. These batteries were all located at Fort Hamilton. At Fort Wadsworth Batteries Catlin and Turnbull, both gun batteries, 3-inch, BC, were to get shields while Battery Dix with its two 12-inch, DC guns was to go as was the one 6-inch, DC, gun of Battery Mills. A new 16-inch battery and a new 6-inch battery was to be constructed at Fort Wadsworth.

In the Harbor Defenses of Sandy Hook, Forts Hancock and Tilden, Batteries Richardson and Bloomfield, both two 12-inch, DC, gun batteries were to be abandoned at Fort Hancock as was Battery Gunnison, two 6-inch, DC, guns. Battery Mills and Kingman, each of two 12-inch, BC, guns to be casemated. Battery Peck, two 6-inch, BC, guns was to get shields, as were Batteries Norris (4 guns) and Urnston, (2 guns) 3-inch, BC, guns. At Fort Tilden Battery Harris, two 16-inch,

BC, guns, was to be casemated and Battery Kessler, two 6-inch, BC, guns, was to get shields. Battery Fergusson, two 6-inch, BC, guns, was to be replaced by new construction. This new construction was to include a battery of 16-inch guns in the vicinity of Sandy Hook and another in the vicinity of Fort Tilden. A modern 6-inch battery was to be constructed in the vicinity of Sandy Hook with another, built to replace Battery Fergusson, at Fort Tilden.

In the Harbor Defenses of the Delaware Batteries Hall and Haslet, each with two 12-inch, BC, guns, were to be casemated at Fort Saulsbury. At Cape Henlopen (Fort Miles) only one major calibre, fixed sea coast battery was in the current project although work of construction had not been started. It was the 16-inch, BC, casemated battery then known as construction number 118. Other batteries at Capes Henlopen and May were mobile outfits, two 155mm batteries and a two-gun 8-inch railway battery. These mobile batteries were to be removed upon completion of the projected construction which included another 16-inch casemated battery at Cape Henlopen, two 6-inch batteries at Cape Henlopen and one 6-inch battery at Cape May. At Fort Mott, Delaware, Battery Arnold was to be abandoned without delay. At Fort DuPont Battery Elder, two 3-inch guns, was to be shielded. At Fort Delaware Battery Torbert with three 12-inch, DC, guns was to be abandoned in favor modernization while battery Hentig's two 3-inch, BC, guns were to get shields.

By this program it is seen that the seacoast defense policy favored harbor defense on "sixteens and sixes," and the death knell of the disappearing carriage was sounded. Some twelves and three inchers were retained.

The 2nd Coast Artillery District was in the midst of this planning with the advent of hostilities. However the gathering war clouds already had impelled the War Department to order certain measures during modernization in a letter

of July 16, 1941 from the Adjutant Generals Office as follows:(Ref. Mod. File)

"Inasmuch as the batteries to be casemated (modernized include, in general, the most effective of the the existing types, it is desirable that precautions be taken to minimize the loss of fire power during the period of reconstruction. Accordingly, separate instructions will be issued by the Chief of Engineers requiring that the Engineering operations during the period of reconstruction be carried out in a manner that will permit at least one gun of any battery being modernized, together with adequate ammunition and fire control equipment and electric power, to be capable of readiness for service firing on not over 24-hours notice."

Sector was facing a task of many facets. It was like a chef trying to prepare a banquet, with assistants who had to be trained, while repairmen were fixing the stove and while the menu was be constantly changed. It was a case of training troops, juggling armament during modernization so as to be always ready to fulfill a mission, and of modifying plans to meet the needs of the ever-changing war situation.

While the "Northeastern Theater" plan was the plan put into effect, the so called "Rainbow" plan was already in the staff "mill" and changes in organization, designations and nomenclature were to come rapidly. Due to this the "NET" plan had a short life, being superceded less than two months later by the New York-Philadelphia Sector. Joint Defense Plan - 1942 based on Rainbow Plan No. 5.

Even as the "NET" plan was being drawn, the War Department letter of March 17, 1941 had already changed the designation of the next higher eschelon of command for Sector to the Northeastern Defense Command and linked that command to the command of First Army. (See "Background of Sector")

But this designation was to have short life with the war actually upon us and so the picture shifts again with a drastic change in the set-up of Sector's superior command when the Eastern Theatre of Operations was created. This new territorial division of command encompassed the entire Eastern Seaboard including

the Florida Peninsula with Lieutenant General Drum Commanding General as of 12 noon, EST, 24 December 1941, Headquarters Governor's Island, N.Y.

General Orders No. 1, Eastern Theater of Operations, dated December 21, 1941, directed the following:

Secret immediate action letter, W.D. 20 December, 1941 creates ETO embracing U.S. Bases in New Foundland and that portion of continental U.S. east of the following rear boundary: Ohio-Pennsylvania boundary; Ohio-W. Virginia boundary; Kentucky - Virginia boundary; thence I. & N RR. to Knoxville; thence along Southern RR. via Chattanooga to Birmingham; thence via Selma, Ala. to NW corner of Florida; thence south along the Alabama-Florida boundary to Gulf of Mexico.

**Forces : First Army**

1st. and 3rd Air Force

Units 1st. 2nd, 3rd Corps Area including attached units and that part of 4th and 5th in area.

**Forces in New Foundland**

Base command, NF

General depots, air depots, schools, training units and facilities of air corps and other establishments under War Dept., control not disturbed except in case of emergency.

Parts of former Northeast Defense Command lying within the boundaries of ETO absorbed.

Area west of said boundaries is transferred to the Central Defense Command as of the date and hour preceding.

Units passing to new command operate under current plans until otherwise directed.

The graphic picture of Sector Command with the command of which Sector was a part now appeared as shown on Plate No. 7.

General Orders No. 6, Hq. Eastern Theater of Operations and First Army, dated 12 January 1942 outlined the unification of command and shows the place of New York-Philadelphia Sector in the overall scheme of coastal defense, now under one command from Maine to Florida.

This order read that Hq. Eastern Theater of Operations and First Army consist of commander and such staff as necessary to act on plans, policies and

SECRET

directives, and supervision of execution. Staff groups of Eastern Theater of Operations and First Army function jointly under chief of staff, First Army.

Also that the "present system of defense comprising the New England, New York-Philadelphia and Chesapeake Bay Sectors is extended to include the Southern Sector (4th Artillery District) and the New Foundland Base Command. Commanders of these above will report directly to Commander ETO.

A graphic representation of this organization of command is shown by plate No. 8.

#### AAAC

The Antiaircraft Artillery Command, while not a part of Sector Command (See Plate No. 8) was a part of the closely knit defense of the coast and, under certain conditions, actively a part of Sector operations beyond the responsibility of local defense by fixed AA guns in the harbor defenses.

The Antiaircraft Artillery Command, Eastern Theater of Operations (later Eastern Defense Command) was created as such by General Orders No. 7, Hq. ETO and First Army, to supersede the Provisional First Army Antiaircraft Command. The date was 13 January, 1942.

Major General Sanderford Jarman, U.S. Army was designated as the Commanding General and still held that command in January, 1944, with headquarters at Fort Totten, N.Y.

The AAAC, ETO comprised the headquarters and all Antiaircraft Artillery units assigned or attached to the Eastern Theater of Operations (Eastern Defense Command) within the continental limits of the United States.

The Commanding General of this command was charged with:

"The organization, training, administration, discipline, and employment of his forces.

"The tactical control and training of harbor defense artillery troops in

the Theater (Defense Command) assigned solely to antiaircraft artillery armament (except automatic weapons protecting seacoast artillery installations). The tactical employment and training of harbor defense assigned to antiaircraft artillery armament as a dual mission will be coordinated with the Defense Sector Commanders concerned. The maintenance, supply, administration and discipline of harbor defense troops assigned to antiaircraft artillery armament is a function of Defense Sector and Harbor Defense Commanders."

A further elaboration of the air defense picture in relation to Sector is found in the wording of Field Orders, Hq. New York-Philadelphia Sector in which it is stated, to paraphrase:

Except for local defense by all units, the defense of the New York-Philadelphia Sector against hostile air attack is charged jointly to the First Air Force and the Antiaircraft Artillery Command, EDC. Fixed antiaircraft artillery batteries have an additional mission of supporting the harbor defenses with fire on available water borne targets.

The first of New York-Philadelphia Sector's series of Rain<sup>b</sup>bow plans was approved on January 20, 1942 in the midst of all these changes in organization and was distributed to lower eschelons of sector command and affiliated commands on February 4, 1942. (See Plate No. 7)

The approval was signed by R. E. Haines, Brigadier General, U.S. Army, Commanding, for the New York-Philadelphia Frontier Defense Sector; by Adolphus Andrews, Rear Admiral, U.S. Navy, Commandant, for the Third Naval District; and by H.E. Cook, Captain, U.S. Navy, Acting Commandant, for the Fourth Naval District.

The changes in this plan, compared to that of 1941 included a redesignation of the northern boundary as "Wantuck Shoals Light - Shinnecock Light (excl) - West Longitude 72 32' - Long Island Sound - Connecticut - New York Boundary." This, of course, also changed the northern boundary of New York Subsector to coincide.

But perhaps the greatest change, referred to in previous pages, was that which divorced the Antiaircraft Artillery from Sector Command and we find the new plan listing "forces available" under subsector less the 34th C.A. Brigade

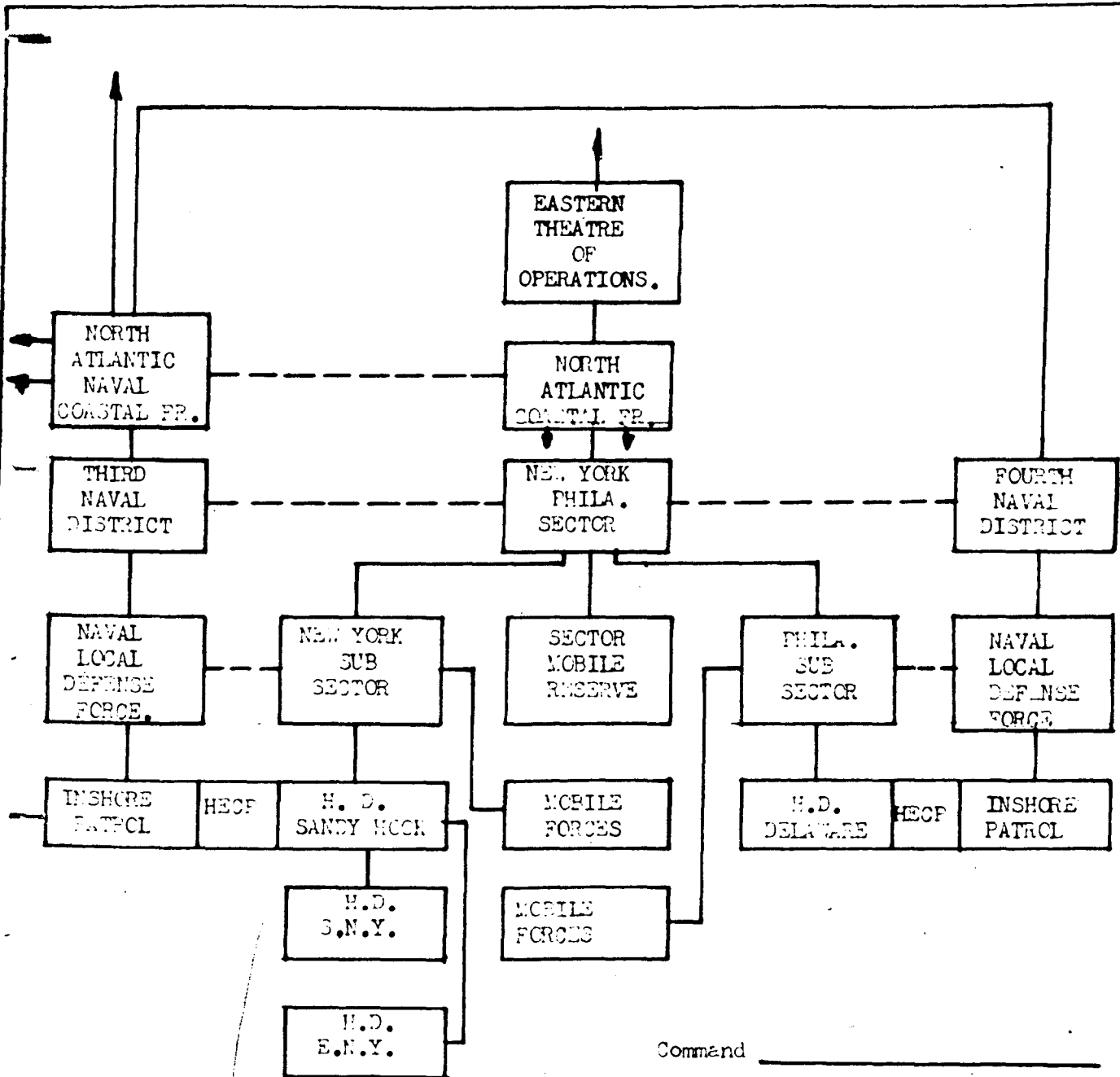

Command \_\_\_\_\_

Joint Operation and Joint Planning \_\_\_\_\_

ORGANIZATION CHART  
NEW YORK - PHILADELPHIA SECTOR

Joint Defense plan January 20, 1942.

for the New York Subsector and less the 28th C.A. Brigade for the Philadelphia Subsector as compared to the '41 plan.

The two battalions C.A. (TD) (155mm gun) were also removed from the list and the assignment of a specific division of troops (28th Division) was eliminated in favor of the designation "such mobile troops as may be attached."

Other changes were made to conform to the changes in organization noted above, including those in nomenclature. In the plan Fort Miles appears in the planning picture by name for the first time.

But the changes were not complete. In little more than a month after the distribution of Sector's Joint Plan of 1942 another change was effected in the over all tactical set-up. At that time it did little more than change title of command from the Eastern Theater of Operations and First Army to the Eastern Defense Command and First Army. The change also shifted troop strength, did away with ETO Service Command, turning those duties over to divisions of G-Staff and worked other small economies of command.

This change is described in General Orders No. 1, dated 20 March 1942, Eastern Defense Command and First Army, with General Drum Command General "as of 1201, this (20 March 1942) date. It follows in part:

According to instructions War Dept. letter, March 13, 1942 ETO becomes EDC and is not Theater of Operations. Territorial Limits same as ETO of December 21, 1941.

Mission same

Command - First Army less I and VI Army Corps, including troops assigned or attached. Less units attached to defense sectors.

Air Force ETO changed to Air Force EDC

AAA ETO " " AAA EDC

Newfoundland Base Command

Defense Sectors with all units assigned or attached I and VI Army Corps, including attached or assigned units less units attached to sectors, air bases and Corps areas, pass to control of CG Army Ground Forces at their present stations, this date.

Service Command ETO absorbed in EDC divisions of G-Staff.



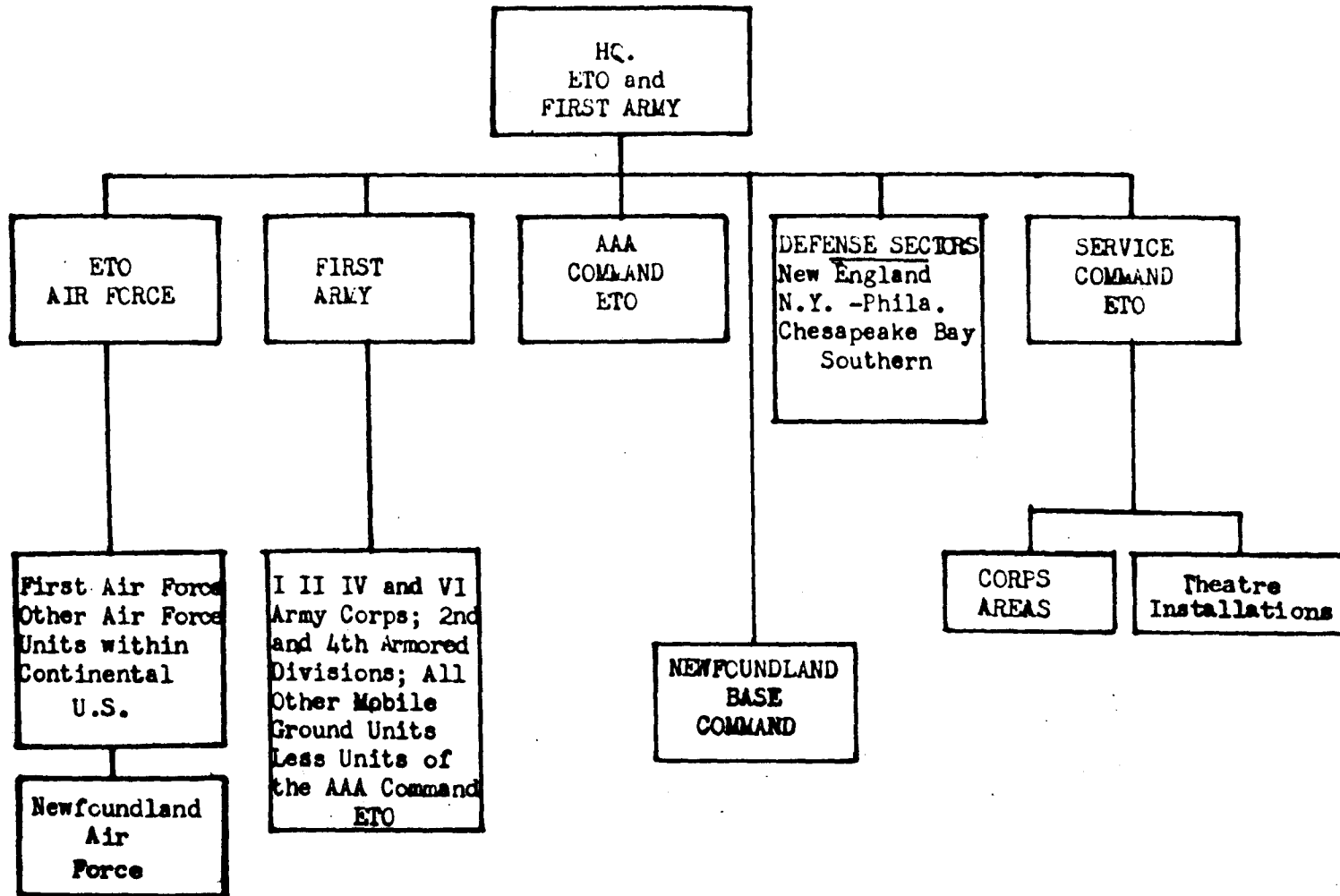

for the New York Subsector and less the 28th C.A. Brigade for the Philadelphia Subsector as compared to the '41 plan.

The two battalions C.A. (TD) (155mm gun) were also removed from the list and the assignment of a specific division of troops (28th Division) was eliminated in favor of the designation "such mobile troops as may be attached."

Other changes were made to conform to the changes in organization noted above, including those in nomenclature. In the plan Fort Miles appears in the planning picture by name for the first time.

But the changes were not complete. In little more than a month after the distribution of Sector's Joint Plan of 1942 another change was effected in the over all tactical set-up. At that time it did little more than change title of command from the Eastern Theater of Operations and First Army to the Eastern Defense Command and First Army. The change also shifted troop strength, did away with ETO Service Command, turning those duties over to divisions of G-Staff and worked other small economies of command.

This change is described in General Orders No. 1, dated 20 March 1942, Eastern Defense Command and First Army, with General Drum Command General "as of 1201, this (20 March 1942) date. It follows in part:

According to instructions War Dept. letter, March 13, 1942 ETO becomes EDC and is not Theater of Operations. Territorial limits same as ETO of December 21, 1941.

Mission same

Command - First Army less I and VI Army Corps, including troops assigned or attached. Less units attached to defense sectors.

Air Force ETO changed to Air Force EDC

AAA ETO " " AAA EDC

Newfoundland Base Command

Defense Sectors with all units assigned or attached I and VI Army Corps, including attached or assigned units less units attached to sectors, air bases and Corps areas, pass to control of CG Army Ground Forces at their present stations, this date.

Service Command ETO absorbed in EDC divisions of G-Staff.

for the New York Subsector and less the 28th C.A. Brigade for the Philadelphia Subsector as compared to the '41 plan.

The two battalions C.A. (TD) (155mm gun) were also removed from the list and the assignment of a specific division of troops (28th Division) was eliminated in favor of the designation "such mobile troops as may be attached."

Other changes were made to conform to the changes in organization noted above, including those in nomenclature. In the plan Fort Miles appears in the planning picture by name for the first time.

But the changes were not complete. In little more than a month after the distribution of Sector's Joint Plan of 1942 another change was effected in the over all tactical set-up. At that time it did little more than change title of command from the Eastern Theater of Operations and First Army to the Eastern Defense Command and First Army. The change also shifted troop strength, did away with ETO Service Command, turning those duties over to divisions of G-Staff and worked other small economies of command.

This change is described in General Orders No. 1, dated 20 March 1942, Eastern Defense Command and First Army, with General Drum Command General "as of 1201, this (20 March 1942) date. It follows in part:

According to instructions War Dept. letter, March 13, 1942 ETO becomes EDC and is not Theater of Operations. Territorial limits same as ETO of December 21, 1941.

Mission same

Command - First Army less I and VI Army Corps, including troops assigned or attached. Less units attached to defense sectors.

Air Force ETO changed to Air Force EDC

AAA ETO " " AAA EDC

Newfoundland Base Command

Defense Sectors with all units assigned or attached I and VI Army Corps, including attached or assigned units less units attached to sectors, air bases and Corps areas, pass to control of CG Army Ground Forces at their present stations, this date.

Service Command ETO absorbed in EDC divisions of G-Staff.

EDC will maintain agencies to handle all duties heretofore assigned to Service Command ETO insofar as they pertain to EDC.

Shortly afterwards, however, a change in the boundary of command was made by General Orders No. 5, dated 5 April 1942, Eastern Defense Command and First Army, which shifted the southern extremity of the westward boundary from Sulphur Springs, Ga. southward as follows:

"Sulphur Springs (EDC) southward along boundary between Alabama and Georgia to the northern boundary of Florida - south along the Chalahoochia and Apalachicola rivers to Apalachicola, Fla."

A sketch map, plate No. 9, shows these changes graphically.

The organization within Sector underwent a change shortly afterwards when the separate harbor defenses of the New York Subsector became one, the Harbor Defenses of New York. This change was putting into effect what already had been accomplished to all intents and purposes since the Harbor Defenses of Sandy Hook had been acting in the capacity of central command for the other harbor defenses. The new set-up simplified administration procedures however.

The Harbor Defenses of Sandy Hook, Southern New York and Eastern New York was abolished in General Orders Number 5, New York - Philadelphia Sector, dated 4 May 1942, pursuant to the authority contained in the 2nd Ind, War Department letter AG 660.2 (4/7/42) MC-E, dated 27 April, 1942 and the Harbor Defenses of New York activated by the 2nd Ind. on letter (Mod. File) Hq. New York-Philadelphia Sector, subject "Modernization of Harbor Defense Projects, Continental United States, "dated 7 April 1942.

The picture of Sector organization was then that shown by the chart depicted on Plate No. 10.

The Nomenclature was also changing on the other side of the Joint Action picture to effect parallel commands of Army and Navy. A letter of 7 May 1942 directs changes in the designation of the North Atlantic Coastal Frontier to

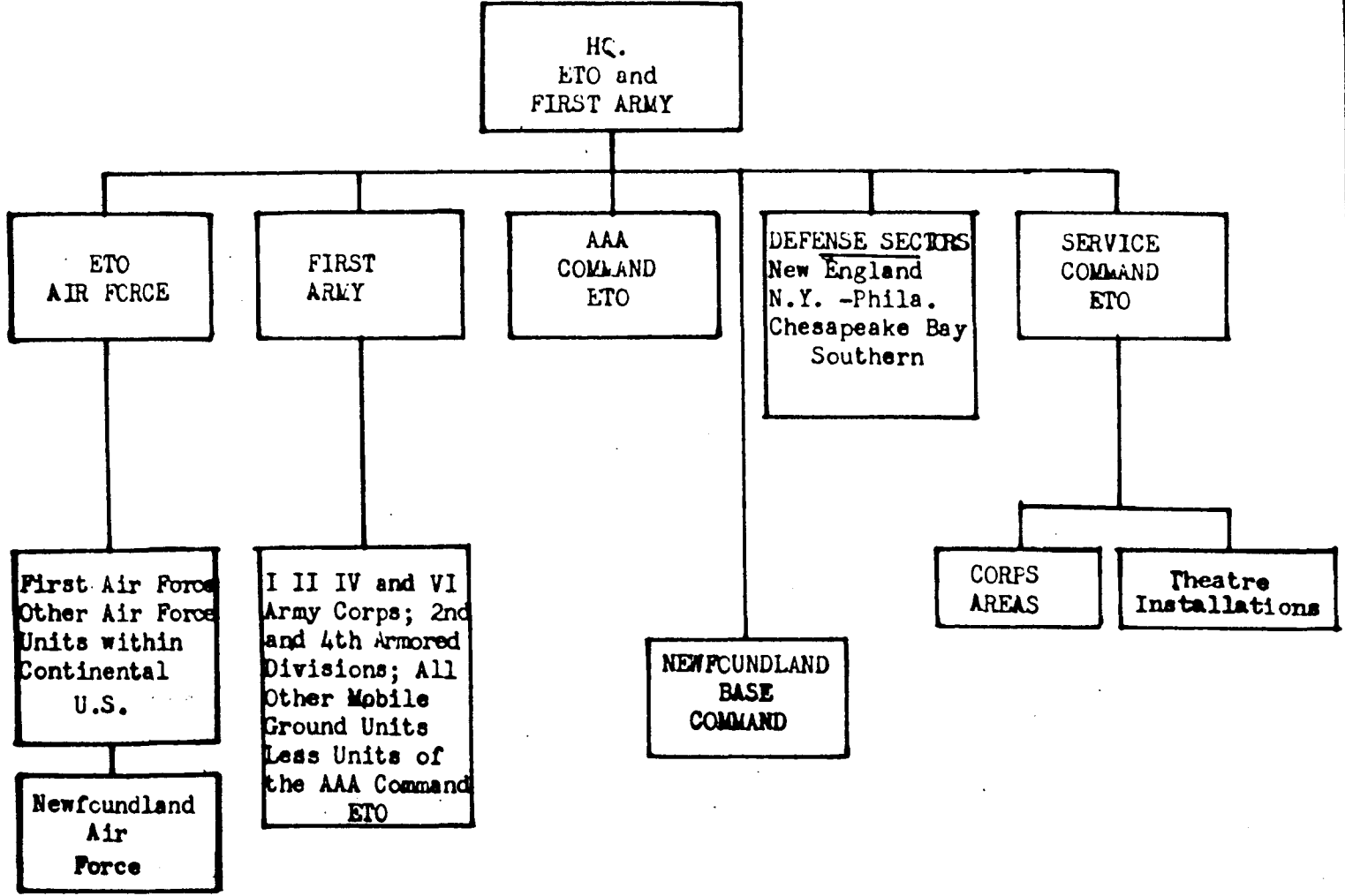

PLATE #8

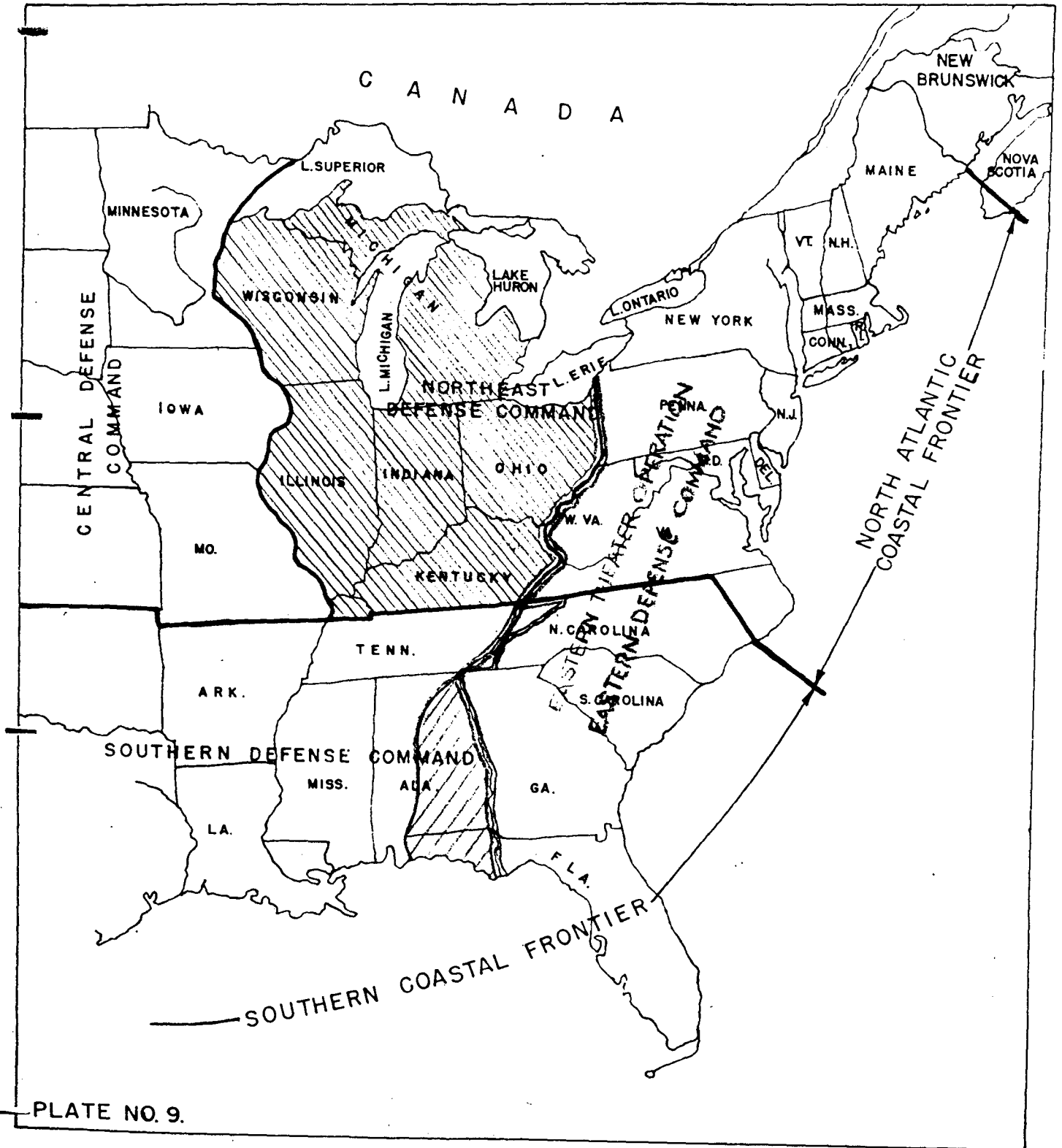
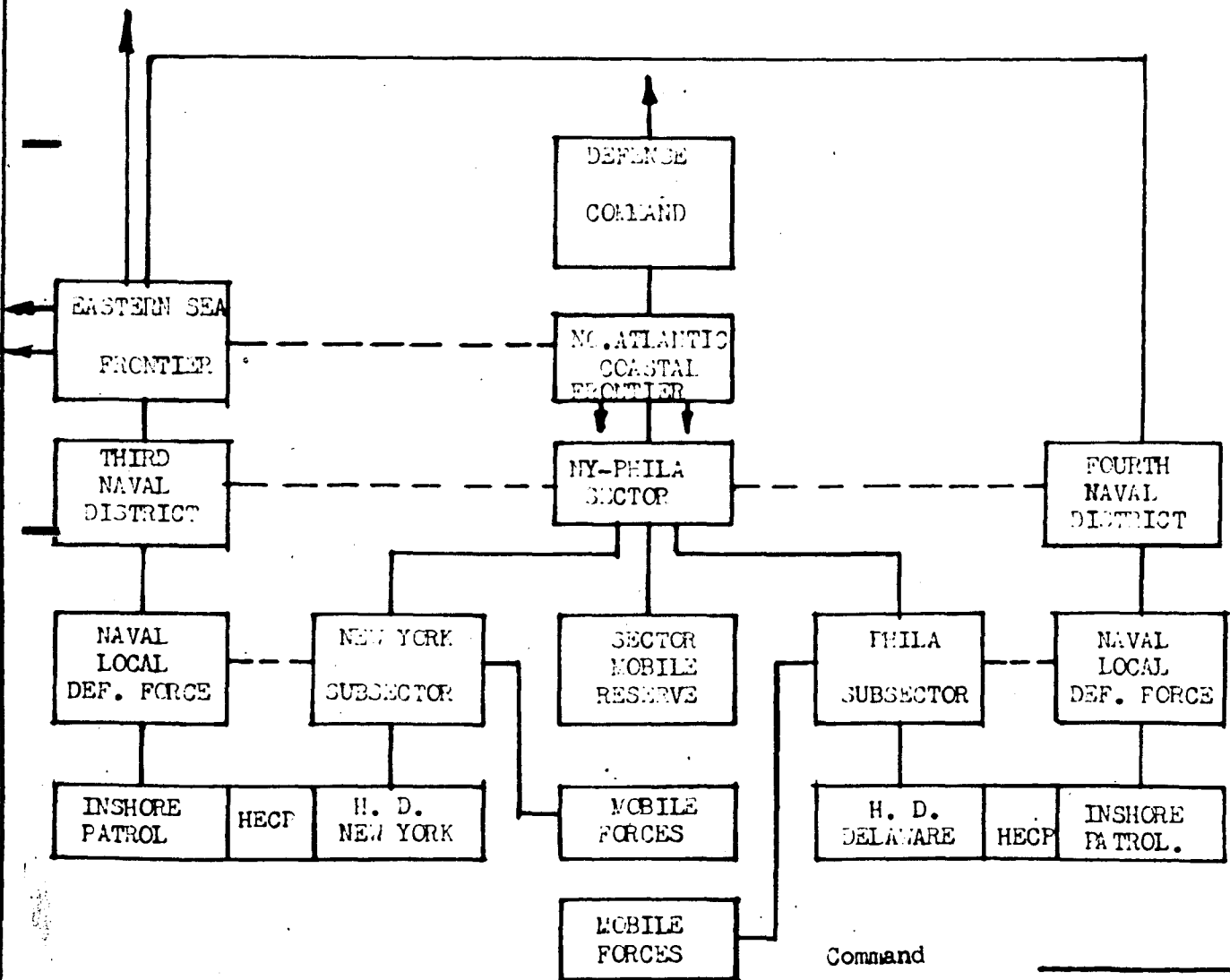

PLATE NO. 9.

- DEFENSE PLAN, WAR DEPT LETTER TO C.G. FIRST ARMY, MAR. 17, 1941.  
 A.G.320.2(2-28-41) M-WPD-M
- GO No.1 ETO 21 DEC. 1941.
- GO No.1 EDC 20 MAR. 1942.
- REAR BOUNDARIES OF ATLANTIC COAST NAVAL DISTRICTS.

ORGANISATION CHART - NEW YORK - PHILADELPHIA SECTOR

Corrected to May 6, 1942.



Command \_\_\_\_\_  
Joint Operation and Planning \_\_\_\_\_

the Eastern Sea Frontier, for the Navy, and the Eastern Theater of Operations to the Eastern Defense Command by joint agreement of the Commandant, Third Naval District and the Commanding General, New York-Philadelphia Sector.  
(381/73 Gen.)

The problem of how to meet the problem of attack from the motor torpedo boat was another of the many facing Sector Command as defenses were adjusted to meet the threats of modern warfare. This particular problem had been the subject of much study and planning during pre-war period but, due to the unusual demands of stepping up of production to meet war demands priorities forced Sector to get along with what it had until supply of armament caught up with the more urgent needs.

To prepare for the threat of attack from motor torpedo boats the War Department directed the Commanding General of the then Eastern Theater of Operations to utilize armament on hand and under the control of the command in motor torpedo boat defense in a letter February 21, 1942. (See 381/57 Gen.)

At that time special types of sights and fire control equipment and a 90mm fixed mount was under development for defense against motor torpedo boats but were not available to meet immediate requirements. Alternative armament that could be employed was the 37mm gun, the 3-inch seacoast gun, the 3-inch fixed and mobile anti-aircraft gun and the 90mm mobile antiaircraft gun. The command authorized in this letter to resite existing 3-inch fixed seacoast and anti-aircraft batteries "where essential" and "call upon the War Department for such additional portable 60-inch searchlights as may be found necessary.

This letter inspired a re-examination of the siting of 3-inch and AA batteries within the harbor defenses of New York and the Delaware. This resulted in the plan, approved in April, 1942, to relocate four guns of Battery Catlin at



SECRET

Seagate (Norton's Point); four guns of Battery Turnbull at a more advantageous location at Fort Wadsworth, the remaining two guns of the battery being relocated at Fort Miles, Del., and the relocation of Battery Urnston to a site in the vicinity of Battery Gunnison. At Fort Miles, Del., the two guns of Battery Turnbull were to be augmented by two guns from Battery Hentig, Fort Delaware, and emplaced at "Location #5" and was recorded as project No. 392.

Another relocation of 3-inch batteries in the Harbor Defenses of the Delaware constituted the shifting of Battery Elder's two guns from Fort DuPont to Liston Range on the Delaware River to protect a Navy installation of an anti-motor torpedo boat boom at that place, . . . This relocation battery had a short life, being placed by June, 1942 and dismounted by March 1943.

This expediency of armament relocation supplanted by 1943 when batteries of four 90mm guns were sited as follows. Two batteries at Fort Hancock, one battery at Rockaway Point, one battery at Norton's Point, and one battery at Miller Field, Staten Island, one battery at Cape May, N.J. and two batteries on Cape Henlopen at Fort Miles. A 2-gun battery of 90mms was sited on Swinburne Island in New York Harbor. These defenses were augmented by 37mm guns. As a standard practice 90mm batteries were made up of two fixed and two mobile mounts.

A change in Command of Sector was effected. Date in 1942.

The New York-Philadelphia Sector came under a new commanding General with the departure of Brigadier General Ralph E. Haines for Fort Winfield Scott when he relinquished his Sector Command 29 September 1942. He was replaced by Major General John L. Homer, 9 October 1942, the interim Commanding General being Brigadier General Philip S. Gage, Commanding General, New York Subsector.

(\*)

Major General Homer came to Sector Command from Iceland and Base Command,

where he was Chief of Staff for Major General Charles H. Bonesteel, and for which outstanding service he was awarded the Legion of Merit on War Department Orders dated 4 January 1944.

General Homer's Sector Staff was then constituted, as published at Fort Hamilton 1 November 1942, as follows:

---

(\* Major General John L. Homer was advanced from the rank of Brigadier General on August 17, 1942, with date of rank from August 3, 1942.

---

Sector Commander	Maj. Gen. J. L. Homer, 03115, U.S.A.
Assistant	Col. Earl Biscoe, 01674, CAC
S-1	Lt. Col. Henry V. Rector, 0208908, CAC (DS C & GSS)
S-2	Lt. Col. John S. Kayer, 0217175, CAC
S-3 & Antitank Officer	Lt. Col. Paul A. Jaccard, 016694, CAC
S-4	Col. Albert M. Jackson, 05854, CAC
ASST S-4	Maj. James C. O'Connor, 0288947, CAC
Asst S-4 (Automotive)	Capt. Frederick A. Dickey, 0327575, CAC
Adj. Gen. & Actg. S-1	Maj. Benito Morales, 0301225, AGD
Asst. Adj. Gen.	Capt. William A. Craig, 0347014, AGD
Asst Adj. Gen. (Classification O)	1st Lt. Everett H. Davey, 0390319, AGD
Inspector General	Col. Samuel J. Taylor, 0145463, IGD
Judge Advocate	Lt. Col. Frederick H. Hauser, 0311304, JAGD
Quartermaster (Actg)	Lt. Col. Charles Crane, 0163576, CAC
Ordnance Officer & Chemical Warfare Officer	Capt. Francis S. Payne, 0364767, Ord
Communications Officer & Cryptographic Security Officer	Capt. John C. Austin, 0343959, CAC

Asst. Comm. Officer	2nd Lt. Jules W. Harter, 01080287, CAC
S.O. Hq. Co. & Property Officer	Capt. John B. White, 0354483, CAC
Spl. Services Officer	1st Lt. Samuel M. Lovenstein, 0267633, CAC
Liaison Officers (3RD & 7SF)	1st Lt. David Cooper, 025860, CAC 1st Lt. Edward S. Rice, 025119, CAC
Liaison Officers (4RD)	1st Lt. John A. Eriksen, 0405877, CAC Lt. Col. Edward J. Richards, 0241036, CAC, 245th CA Maj. Ernest L. Small, 0123686, CAC Capt. Aubrey D. Reid, 0255099, CAC

Captain George W. Shine became General Homer's Aide-de-Camp on October 13, 1942.

During this period with the enemy being driven back on the seas and the magnitude of the war effort in European and Asiatic Theaters, with the resulting drain on manpower resulted in the Eastern Defense Command and First Army Headquarters modifying the Category of Defense of the command. Subsequently the War Department designated certain units of the Coast Artillery in Defense Commands as "Limited Service Units" in view of the manpower pinch.

In a letter of October 29, 1942 the Defense Command advised that as a result of a study of enemy capabilities by the War Department an attack by a major Axis fleet was deemed a remote probability and actions of the "commando type" were deemed improbable and that only probability was that of isolated raids by submarines and light vessels.

Due to this study the Eastern Defense Command directed that the "present" category of defense "C" be reduced to Category "B" as applied to Harbor Defense batteries in excess of 6 inches, exclusive of 155mm weapons but that "existing" category of Defense "C" be maintained on all other installations.

It was also directed that 8-inch DC and 10-inch DC be placed in the status of "no longer required," and that 6-inch DC guns be placed in class "C", care-taking status.

Exception to this directive were noted for the following armament in the Harbor Defenses of New York which were to be placed in Class "B", maintenance status: Battery Doubleday, Battery Brown, Battery Dix, Battery Bloomfield and Battery Richardson, all consisting of 12-inch DC, two-gun batteries.

The personnel released by the change in status of older batteries were to be used in manning the larger caliber batteries as they were completed in the modernization program. (Ref. 381/125 Gen.)

To depart from the chronological order; Sector was not placed in an unqualified category of Defense B until May 26, 1943 by order of SEC. A "state of non-invasion" had been declared for Sector operating Area 19 April 1943. 1942

With the object of releasing men for duty on foreign fronts, certain units of the Coast Artillery in Defense Commands were designated as "Limited Service Units" in a letter from SOS, War Department to the Eastern Defense Command on November 11, 1942 in which the units were authorized a 15 per cent, overstrength for the purpose of replacing General Service personnel. The overstrength was to be maintained until "such time as all General Service personnel have been recovered from the units designated. General Service personnel thus released will be reported for reassignment as rapidly as Limited Service replacements can be trained. In no case will General Service enlisted men be retained in a unit longer than sixty (60) days after the 15 per cent overstrength of Limited Service replacements have been received.

The initial fillers to T/O strength, plus 15 per cent, will be based upon reports of shortages of enlisted men received from the Eastern Defense

Command November 2, 1942 the letter stated.

The Limited Service Units of the Eastern Defense Command were listed as:

Hq. and Hq. Btry.,	New England Sector
" " " "	New York-Philadelphia Sector
" " " "	Chesapeake Bay Sector
" " " "	Southern Sector

Harbor Defense

8th CA (HD) (Type B)	
240th " " " "	A
22nd " " " "	B
9th " " " "	A
241st " " " "	C
10th " " " "	B
243rd " " " "	A
11th " " " "	B
242nd " " " "	A
23rd " Bn. " "	D (Sep)
* 7th " (HD) " "	B
* 245th " " " "	C
* 5th " " " "	A (Less 2 Bns.)
* 21st " " " "	B (Less 2 Bn.)
* 261st " Bn. " "	D (Sep)
* 2nd " (HD) " "	C (Less 1 Bn)
246th " " " "	A
263rd " " " "	B
265th " " " "	B

General Service Units of the Eastern Defense Command were listed as:

46th CA (155 mm gun) (Tr. drawn)	
50th " ( " " ) ( " " )	(Less 3rd. Bn.)
53rd " ( " " ) ( " " )	
* 52nd " (RY) (Less Btry. E)	
* All personnel of the Army Mine Planter Service.	

\*Denotes units in New York-Philadelphia Sector.

A change in the Modernization Program that affected Sector was made by the War Department in a letter of 13 November, 1942 - AG 660.2 (11-12-42) OB-S-E - in order to place this (modernization) program in a workable condition and to effect a reduction in the requirements for seacoast batteries in line with the acute shortage of critical materials. This change eliminated nine projected 16-inch seacoast batteries in Eastern Defense Command, two of them within the boundaries

of Sector.

One, "Construction No. 117", in the Harbor Defenses of New York, was to have been built in the vicinity of the Jamaica Sea Airport, N.Y., and the other, "Construction No. 119," in the Harbor Defenses of the Delaware, was to have been emplaced at Fort Miles, Del.

The Fort Miles battery was replaced by a 12-inch battery by the transfer of Battery Haslet to a new site at Fort Miles to be known as "Construction No. 519."

With the turn of the year, 1942-43, Sector had reached a strength the could be said to have represented the "end point" under war operation. Temporary fluctuations occurred almost daily and no figure could be called stable but this is a figure that, roughly, remained "stable" within certain limits during the life of New York-Philadelphia Sector's set up as such, or until the early months of 1944.

In the S-1 report for Sector dated 1 January 1943 the following tabulation is given for strength of command: (Ref. 319.1/58)

<u>Unit</u>	<u>Officers</u>	<u>Warrant Officers</u>	<u>Enlisted men</u>
Hq NY-Phila. Sector	27	1	81
Hq & Hq Btry HDNY	10	0	30
52nd CA (Ry) (Less Btry E & 1st Bn) 61		6	951
7th CA (HD)	61	4	1541
5th CA (HD)	37	2	785
245th CA (HD)	96	7	2743
5th CA Mine Planter Btry	2	10	70
15th CA Mine Planter Btry	1	8	41
Ha and Hq Btry, HDD	8	0	33
Band, HDD	0	1	29
21st CA (HD)	28	3	551
261st CA Sep Bn	30	3	576
HD Repl Tng Btry (Prov)	0	0	273
12th CA Mine Planter Btry	1	6	42
113th Infantry	145	3	2814
113th Infantry ROT Tng Center	0	0	1027
199th FA	29	2	478
22nd QM Regt (Trk)	11	0	287
671st Col Co (Sep)	6	0	94
132nd Engrs (C)	14	0	357
137 Sig Rd. Int Co	7	1	227
<b>TOTALS</b>	<b>574</b>	<b>57</b>	<b>13,030</b>

This represented the initial strength of command for Sector in any enemy action. Back of Sector was the Eastern Defense Command (and First Army) with a mobile reserve that could be thrown into any Defense Sector threatened. About this same time, 29 December 1942 the composition of the Eastern Defense Command was briefed, based on "instructions recently received from the War Department," as follows:

"Instructions recently received from the War Department provide for the following:

"Release of the 26th Infantry Division from the EDC with the exception of the following units:

181st Infantry  
 211th FA Bn (Combat)  
 Co. "A", 114th Med Bn  
 Co. "B", 114th Med Bn

"That each Sector of the EDC shall have a combat team to consist of the following listed elements:

1 Infantry Regiment (R)  
 1 FA Bn (105mm How)  
 1 Engr Bn (Combat)  
 1 Med Co (Coll) (or equivalent)

"The transfer of the following listed units into the EDC in order to establish a mobile reserve and to complete the Sector combat teams:

<u>UNIT</u>	<u>PRESENT STATION</u>
144th Infantry	Western Defense Command
101st Cavalry (Mech)	Ft. Devens, Massachusetts
2nd Bn, 133rd Engr (Combat)	Ft. Lewis, Washington
243rd FA Bn (105mm How)	Camp Shelby, Mississippi

The letter also contained "for your information" the plans for the readjustment and the reorganization of the Sector combat teams. For the New York-Philadelphia Sector the combat team at that time was to consist of:

133th Infantry	No change
199th FA Bn	No change
2nd Bn 132nd Engr (less Co. "F")	No Change

Co. "F", 132nd Engr  
671st Collecting Co (Sep)  
Co "F", 22nd M Regt (Trk)  
Co "G", 22nd M Regt (Trk)

From CBS  
No change  
No Change  
No Change

According to the letter the indicated transfers were to be made "in accordance with orders and instructions to be issued by this or higher headquarters."  
(Ref. 320/90)

The recurring problem of the division of command for the eastern end of Long Island where the defenses of the water areas fell into the sphere of the Harbor Defenses of the Narragansett Bay Area, including Long Island Sound, and under the command of the New England Sector, while the local or beach defense was the responsibility of the New York-Philadelphia Sector again called for definition early in 1943. The solution of the problem to meet developments in the situation was reduced to writing in a mutual agreement between the Commanding Generals on May 13, 1943, signed by General Homer for the New York-Philadelphia Sector and by Major General K. T. Blood for the New England Sector. It was approved by the Eastern Defense Command on May 20, 1943. The agreement read:

At a conference held at Boston, Mass., on April 26, 1943, it was agreed between the Commanding Generals, New England Sector and New York-Philadelphia Sector, that:

a. In general, the beach patrols on Long Island will be operated by the troops the New York-Philadelphia Sector, supplemented by Coast Guard patrols.

b. Specifically, the beach front of Camp Hero will be patrolled by Army forces of the New York-Philadelphia Sector until such time as troops of the New England Sector are stationed at Camp Hero, probably about June 1, 1943, at which time the New England Sector will assume responsibility for the Camp Hero patrols and the defense of the Camp Hero beach front.

c. Two flying columns, motorized, consisting of two (2) officers and fifty (50) men each, of such mobile Coast Artillery troops of the New England Sector as may be stationed in the vicinity of Montauk Point, will be kept available for general emergency use. These supporting columns will be subject to call by the commander of the 113th Infantry Battalion Combat Team operating from Riverhead,



Long Island, and while on duty in response to such calls will be under the command of the Commanding General, New York-Philadelphia Sector. The Commanding General, New England Sector, will be notified immediately whenever a flying column is called and upon the termination of the duty.

d. With the exception noted in g. above, the command of all Coast Artillery Troops and of all installations and facilities which pertain to the Harbor Defenses of Long Island Sound located on Long Island within the limits of the New England Sector, will rest with the Commanding General, New England Sector.

A revised agreement, dated October 4, 1942, was reached between the Commanding Generals and approved by Eastern Defense Command October 13, 1942. This revision merely reduced the flying columns available from two to one due to the fact that the 50th CA with its mobile 155s had vacated its camp at Dude Ranch, Montauk Point, for the winter, reducing personnel available for the flying columns to such an extent that Major General Blood felt that the New England Sector could no longer provide two columns.

A change of status for the 137th Signal Radio Intelligence Company was directed by Headquarters, Eastern Defense Command and First Army in a letter to New York-Philadelphia Sector, 9 February 1943 and effective the same date.

This Company was relieved from attachment to Sector and reverted to the control of the Commanding General, Eastern Defense Command and First Army "at present station". The units stationed was Mitchel Field, Long Island, N.Y.

Further it was directed that the unit was attached for administration, same date, 9 February 1943, to the Air Forces, Eastern Defense Command and First Air Force.

This unit had been attached to Sector since October 6, 1942 when it was attached for duty by EDC and FA. It operated along Long Island, New York and New Jersey shores.

Another change in the early months of 1943 that concerned the 113th Infantry Combat Team was that in the operational control of the Combat Team that was direct-

ed by Headquarters, New York-Philadelphia Sector, on March 15, 1943. By means of an operational directive certain units of the Combat Team were relieved from operational control of New York Subsector and read in part: (Ref. 320/118)

"Effective March 17, 1943, the following units are relieved from operational control of the New York Subsector:

Headquarters, 113th Infantry  
Headquarters Company, 113th Infantry  
Anti-Tank Company, 113th Infantry  
Service Company, 113th Infantry  
Band, 113th Infantry  
671st Collecting Company  
Headquarters, 199th Field Artillery  
Headquarters Battery, 199th Field Artillery  
Service Battery, 199th Field Artillery  
Headquarters, 2nd Battalion, 132nd Engineers

"The 1st and 3rd Battalion Combat Teams with attachments operating as a separate battalions remain under control of New York Subsector for tactical operation and training.

"The 2nd Battalion Combat Team with attachments operating as a separate battalion remains under control of Philadelphia Subsector for tactical operation and training.

"The administration and supply of all units of the Combat Team will be the responsibility of Sector Headquarters. Administration and supply channels will be direct from Battalion Combat Teams to Regimental Combat Team Headquarter, Fort. Hamilton, N.Y."

This was one of the early adjustments in Combat Team control within Sector that eventually led to the total divorcement of subsectors from command over Battalion Combat Teams of the 113th Infantry on 1 November 1943 as is shown in following pages.

The later half of 1943 also saw a number of changes in the organization of Sector and within Sector.

Sector Staff was put on General Staff status on 18 August, 1943; subsectors were activated on 31 August, 1943; A change in the territorial organization of troops was effected 1 November, 1943 and the Category of Defense was reduced to

Category "A" on 3 November 1943.

The War Department on 18 August, 1943 authorized General Staff status for each of the four Sectors of the Eastern Defense Command the following changes to Table of Organization authorized in a War Department AGO letter dated 18 August 1943. (File AG 320.21 (7 Aug. 43) PO-M-SPGAS. Ref. 320/149 binder #1)

One colonel, assistant to Sector Commander, is redesignated as Chief of Staff, and four lieutenants colonels, S-1, S-2, S-3 and S-4, are redesignated as G-1, G-2, G-3 and G-4.

The Chief of Staff, and G-1, G-2, G-3 and G-4 of each sector may be detailed in General Staff Corps with troops.

On this authority the following named officers were detailed in the General Staff Corps with troops by General Order No. 15 of Sector, dated 25 August 1943:

Colonel Earl Biscoe, 01674, CAC  
Colonel Albert M. Jackson, 05854, CAC  
Colonel Ernest R. Barrows, 06320, CAC  
Major Aubrey D. Reid, 0255099, CAC  
Captain Robert R. Clark, 0326836, INF

THE SAME General Order No. 15 made the following appointments of General Staff Officers, Headquarters New York-Philadelphia Sector, Major General Homer, commanding.

Chief of Staff	Colonel Earl Biscoe, 01674, GSC
Ass't Chief of Staff (G-1)	Major Aubrey D. Reid, 0255099, GSC
Ass't Chief of Staff (G-2)	Captain Robert R. Clark, 0326836, GSC
Ass't Chief of Staff (G-3)	Colonel Ernest R. Barrows, 06320, GSC
Ass't Chief of Staff (G-4)	Colonel Albert M. Jackson, 05854, GSC

Due to the War Department directive on staff status calling for the rank of Lieutenant Colonel for G-3 and G-4, General Order No. 17, Headquarters New York-Philadelphia Sector, dated 31 August, 1943 redesignated Colonel Ernest R. Barrows as "Acting Ass't Chief of Staff (G-3)" and Colonel Albert M. Jackson as "Acting Ass't Chief of Staff (G-4)".

Following the retirement of Colonel Earl Biscoe, General Orders No. 19, Headquarters, New York-Philadelphia Sector, dated 1 October 1943 made the following changes in General Staff:

"Col. Albert M. Jackson .... is announced as Chief of Staff, Hq. New York-Philadelphia Sector, effective this date, vice Col. Earl Biscoe .... relieved.

"Lt. Col. Charles Crane, 0163576 GSC is announced as Assistant Chief of Staff (G-4), Hq. New York -Philadelphia Sector, effective this date, vice Col. Albert M. Jackson .... relieved."

Up until August 31, 1943 the subsector of Sector had been operating without authorized personnel, a period of nearly two years. On this date General Order No. 16, New York-Philadelphia Sector activated subsector headquarters and headquarters detachments, effective September 1, 1943 for the following subsectors at stations indicated.

New York Subsector  
Philadelphia subsector

Fort Hancock, New Jersey  
Fort Miles, Delaware

The authority was WD letter AG 320.2 (31 July 43) PP-A-M-C, dated 20 August 1943, "Utilization of Personnel," and WCCG EDC and First Army, 31 August 1943.

Personnel was ordered assigned from commissioned and enlisted personnel under subsector command in accordance with T/O & E 4-240-1S, dated 3 July 1943.

Another notation on subsector organization in a message from Sector to subsector commands recognizing dual commands as follows:

"Where by virtue of assignment orders a subsector headquarters is located at a station where a harbor defense headquarters is located, the subsector commander, if a Coast Artillery Officer, shall perform the duties of Harbor Defense Commander. Where in compliance with the foregoing a subsector commander becomes a post commander by virtue of being Harbor Defense Commander, he is authorized to detail a deputy post commander." Ref 320.2/897 NYPS Files

A change in the territorial organization of troops within sector was effected 1 November 1943 by Field Order No. 3, Hq. New York-Philadelphia Sector when the components of the 113th Regimental Combat Team were removed from attachment to

subsectors and placed under the control of the Commanding General, New York-Philadelphia Sector. This changed the organizational picture as far as the Combat Team is concerned from this -

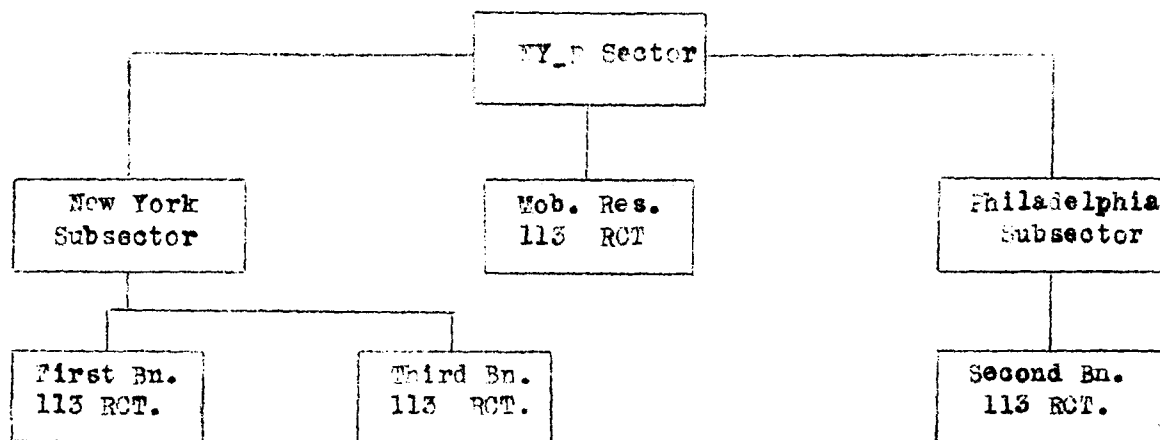

To this -

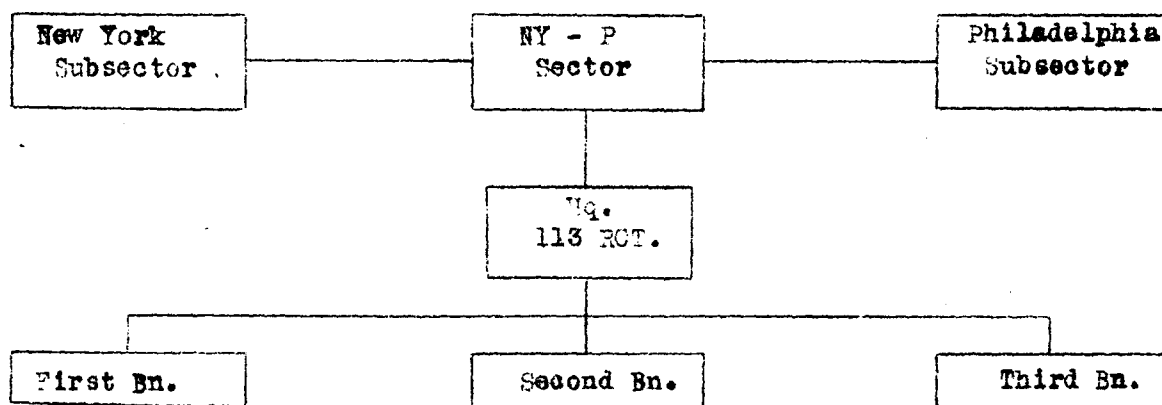

This move, in effect, reduced the command of the subsectors to command of harbor defense troops and armament. It did not relieve them, however, of the mission of supporting Sector Mobile Force with artillery fire in the event of enemy landings on beaches or any other enemy operation within range of seacoast guns, or by supporting Sector Mobile Force with troops when directed to do so by Hq. New York-Philadelphia Sector. While Liaison with the Navy by the Harbor Defense Commanders is still maintained through their respective HECP's, Sector

Mobile Force now maintains liaison through the Operations Room, Hq. New York-Philadelphia Sector. However lateral liaison continues to be maintained by all Sector echelons with adjacent units of Army, Navy and Coast Guard.

The basic argument for a change in the organization of the Infantry Combat Team was put forward by Colonel G. S. Brownell in a then Commanding Officer, 113th Infantry Combat Team, in a report on his visit to New England Sector during a field exercise, dated 2 November 1942, in which he stated, in part:

".... In my opinion the Regimental Combat Team Commander should have complete command of the entire Combat Team under the Sector Commander. It appears to me that under the present organization the Regimental Combat Team Commander does actually control to a large extent the tactical dispositions of the various elements of the Combat Team, but does so, apparently, through the Sector Staff and thence through Subsector Commanders. This appears to me neither necessary nor desirable in this case." (Ref. 381/96 NET)

The division of the beaches by the battalions of the Combat Team in a contemporary diagram is shown on Plate No. 11.

The danger of attack by enemy forces on American shores had become so remote by the end of October that another change in the category of defense for Sector was effected by Change No. 1 to Field Order No. 2. The change, dated 3 November 1943, placed Sector in Category of defense "A" which was declared for this Operating Area on 29 October 1943.

Piecemeal changes were made in this period followed by a general change of the overall plan.

A new detachment was added to Sector Headquarters when the Signal Operation Detachment, with Lt. B.J. McGoldrick in command, was inaugurated by Special Orders No. 281, dated 15 November 1943, with the transfer of personnel effective 17 November 1943.

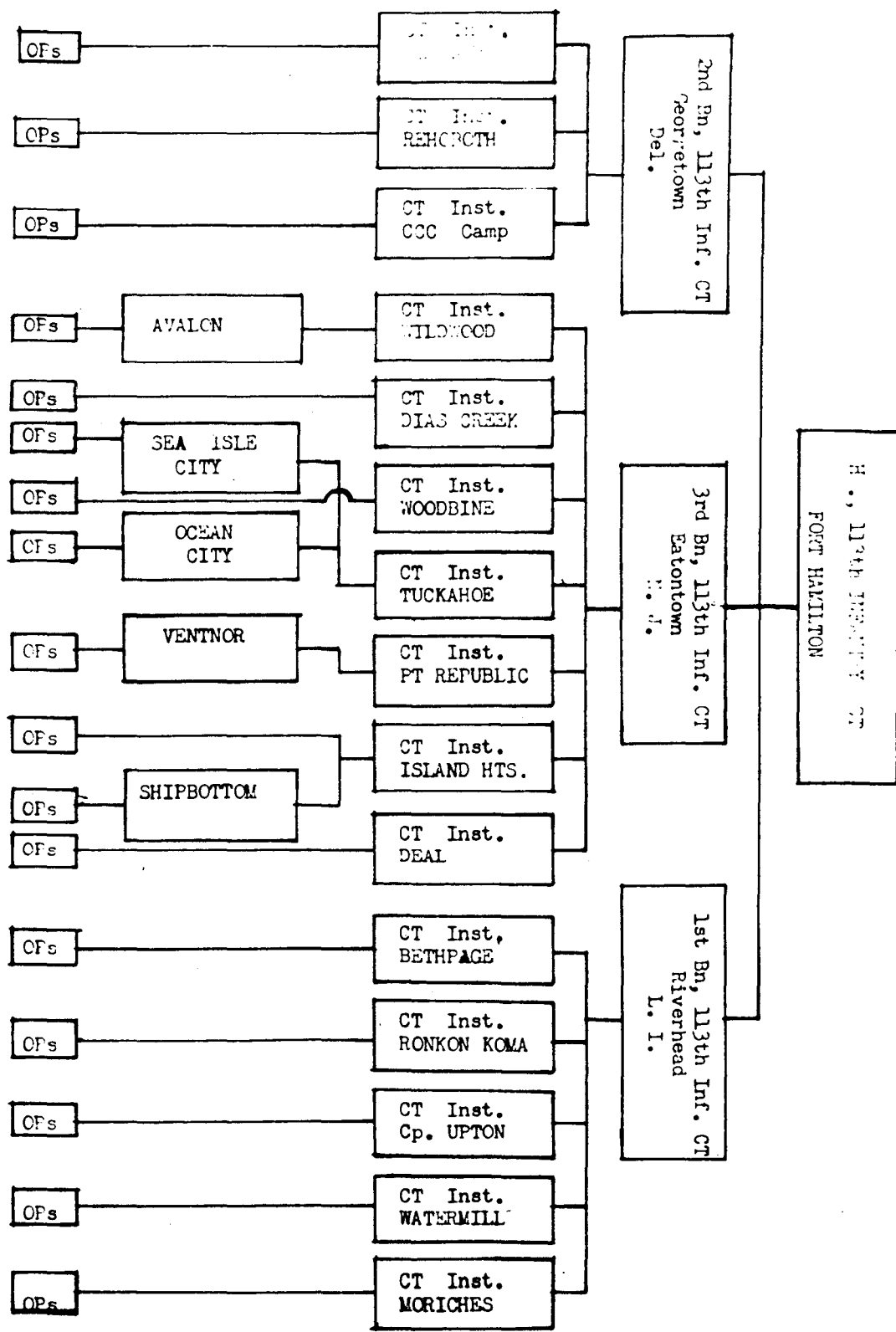

A reduction of forces was effected when the 199th Field Artillery Bn. was divorced from the command of New York-Philadelphia Sector by Movement Orders transmitted in letter dated 23 November 1943 pursuant to authority contained in WD letter AG 370.5 (17 Nov 43) OB-S-GNGCT-M, subject: Transfer of Field Artillery Battalions, dated 19 November 1943. The Battalion (105mm How, Trk-Dr) consisting of the folo

ary stations indicated to Fort  
vember 1943.

Battery A  
Battery B  
Battery C  
Medical Detachment

Ft. Hamilton, N.Y.  
Lake Ronkonkoma, N.Y.  
Eatontown, N.J.  
Georgetown, Del.  
Bethany Beach, Del.

This was a permanent change of station and upon arrival the unit was relieved from assignment to the Eastern Defense Command and assigned to the Army Ground Forces and XIII Corps.

The band of the 113th Infantry was reorganized and redesignated the 275th Army Band by General Order No. 21, Hq. New York-Philadelphia Sector, dated 9 December 1943 which read in part:

"Pursuant to authority contained in War Department letter, AG 322 (27 Nov 43) OB-I-GNGCT-M, 1 December 1943, subject: Constitution, Activation, reorganization and redesignation of Bands, and 1st Ind, Hq. Eastern Defense Command, G-3 - 322, 8 December 1943, the Band, 113th Infantry, will be reorganized, effective 13 December 1943, in accordance with column 2, T/O 5-21, 1 April 1942, with authorized strength of one (1) warrant officer and twenty-eight (28) enlisted men.

"Concurrently with the above reorganization, the band, 113th Infantry, is redesignated as the 275th Army Band.

"Upon redesignation, the 275th Army Band is assigned to the New York-Philadelphia Sector, with permanent station at Fort Hamilton, New York, and attached to the 113th Infantry, with temporary station at Bethpage, New York."

Another plan was called for as changes in the situation on the coast brought about shifts in the military policy and on January 4, 1944 the Joint Plan-43, also based on basic plan Rainbow 5, was distributed to other commands. This plan was drawn up late in the year of 1943 and was approved 27 November 1943 by John L. Hemer,



Major General U.S. Army, Commanding, for the New York-Philadelphia Sector; Edward J. Marquart, Rear Admiral, U.S. Navy, Commandant, for the Third Naval District; and by Milo F. Draemel, Rear Admiral, U. S. Navy, Commandant, for the Fourth Naval District.

This plan gave the final tactical picture of the Sector as we have known is so far. A reorganization of the defense of the East Coast was to absorb the old New York-Philadelphia Sector, most of it in the Southeastern Sector and a small slice of the Northern or Long Island part of it, in the Northeastern Sector as the New England Sector, plus increments, was to be known. This new organization, which was being effected on the first months of 1944, was to divide the East Coast into two sectors only, the Northeastern and Southeastern.

However, for the intervening months of transition the Joint Plan-43 was in operation, based on Category of Defense "A".

The organization and command of the New York-Philadelphia Sector remained substantially the same, the major difference being the separation of the Sector Mobile Force from subsector command. (See Plate No. 12) The territorial or geographic boundaries also remained the same as did command and boundaries in parallel Navy divisions.

In this plan definite limitations were placed on the manning of installations and of armament in keeping with Category "A" which was redefined as:

"Coastal frontiers that probably will be free from attack, but for which a nominal defense must be provided for political reasons in sufficient strength to repel raids by submarines, by surface vessels operating by stealth or stratagem, or isolated raids by aircraft operating chiefly for morale effect....."

Armament and installations on a twenty-four hour alert were:

Harbor Entrance Control Posts and one examination battery per harbor defense, except that one additional examination battery may be designated where necessary to

insure that all entrances open to traffic are within effective range.

Intelligence surveillance by radar and visual stations supported by a minimum of searchlights.

Mines, underwater detection devices, anti-submarine nets, anti-torpedo nets and anti-motorboat booms.

Not more than one anti-motor boat battery for each vital approach.

One harbor defense gun battery of 155mm or 8-inch caliber.

Supporting armament designated in the plan to be prepared to participate in a brief action on notice as indicated - at the discretion of the defense commanders - below:

Not to exceed two guns in anti-motor torpedo boat battery upon 1-hour notice.

155mm batteries and 6-inch batteries upon 1-hour notice.

Remaining armament in maintenance classification B (24 hours) or C (72 hours).

The only changes noted in "forces" was the addition of the Hq. and Hq. Companies of the New York and Philadelphia Subsectors and the addition of the 265th Coast Artillery (HD) which was attached to the New York Subsector and, soon after this plan was distributed, was removed from attachment to Sector.

With the turn of the year from 1943 to 1944 the New York-Philadelphia Sector was in the midst of preparations for moving day, a moving that would mark the end of the old "Sector" and the opening of the new "Sector" to be known as the Southeastern Sector that was to stretch the sphere of command from the Harbor Defenses of New York south to Key West Florida. The new "Sector" headquarters were to go to Raleigh, North Carolina.

The General Staff was occupied in expanding "Sector" plans to meet the move and plans were set by the end of February 1944. This "final" staff under the sign of the "Two Shells" of the New York-Philadelphia Sector, according to the staff Memorandum of February 1, 1944, was:

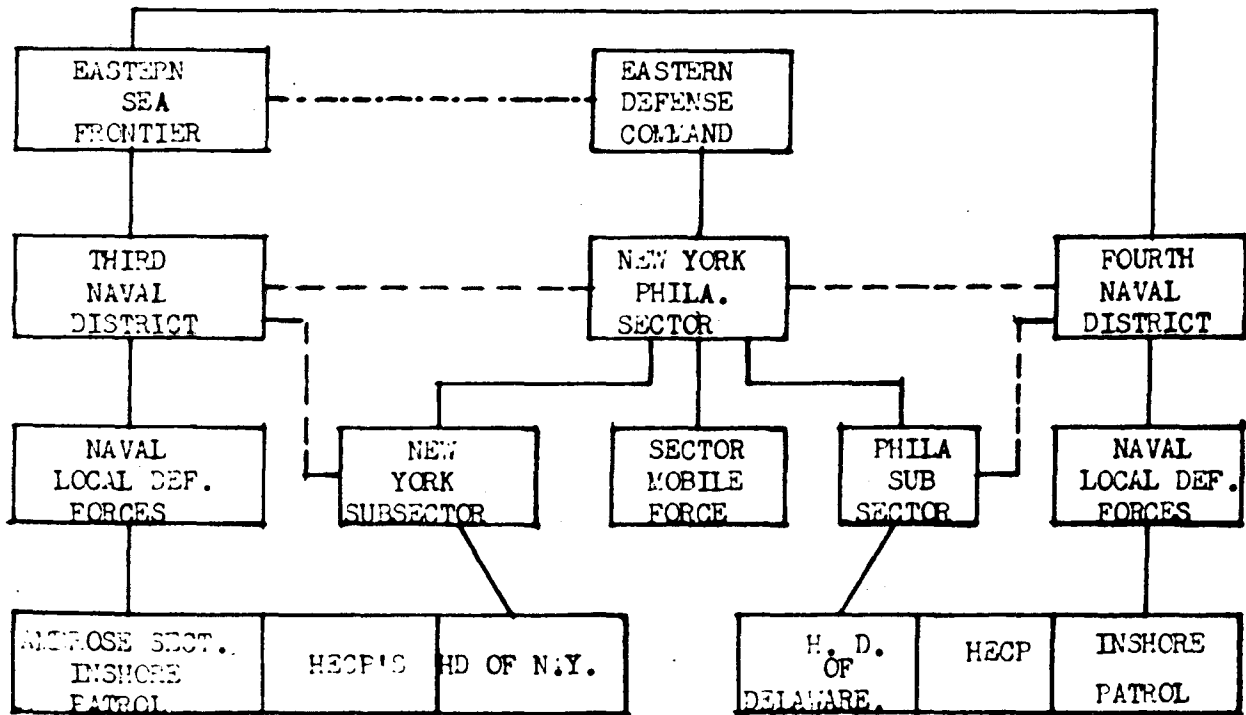

Command

Joint Planning

Joint Planning and Joint Operation -.-.-.-.-

ORGANIZATION CHART

NEW YORK - PHILADELPHIA SECTOR - 3rd and 4th NAVAL DISTRICTS  
 (Original, Nov. 1943, NYPS-JPR5-43)

PLATE #12

55

Sector Commander	Maj Gen J.L. Homer, 03115, USA
Chief of Staff	Col Albert M. Jackson, 05854, GSC
Aide-de-Camp	Capt George W. Shine, 0382506, CAC
AC of S (G-1)	Maj Aubrey D. Reid, 0255099, GSC
Ass't G-1	1st Lt. Robert F. Hille, 01637672 Sig C
AC of S (G-2)	Maj Robert R. Clark, 0326836, GSC
AC of S (G-3) (Actg)	Col Ernest R. Barrows, 06320, CAC
Ass't G-3	Maj Seth F. Hudgins, 021947, CAC
Ass't G-3	Capt. Arthur J. Gallow, Jr., 0361391, CAC, 245th CA
Operations Room Duty Officers	Capt. John A. Friksen, 0405877, CAC
	1st Lt. Melvin Madans, 01041195, CAC
	1st Lt. Charles W. Wilson, Jr., 01080825, CAC
	2nd Lt Kenneth W. Farnham, 01080705, CAC, 245th CA (HD)
AC of S (G-4)	Lt Col Charles Crane, 0163576, GSC
Ass't G-4 & Claim	Maj James C. O'Connor, 0288947, CAC
Ass't G-4 (Automotive)	Capt Francis S. Payne, 0364767, Ord
Adjutant General	Lt Col Benito Morales, 0301225, AGD
Ass't Adj General	Maj William A. Craig, 0347014, AGD
Ass't Adj General (Classification O)	1st Lt. William F. Radcliff, 01000651, AGD
Ass't Adj. General (Personnel O)	1st Lt. William Allan, 01001082, AGD
CO, Hq Co & Property Officer	Capt John B. White, 0354483, CAC
Company Officer & Chemical Officer	1st Lt. Robert T. Bair, 01080915, CAC
CO, SIG Oper Det.	1st Lt Bernard J. McGoldrick, 01167105, Sig C

Communications O & Cryptographic Security Officer	Lt Col James Dreyfus, 0274796, SAC
Ass't Communications O & Cryptographic Security Officer	Capt Jules W. Harter, 01080297, CAC
Ass't Comm Officer & Ass't Cryptographic Security Officer	1st Lt James J. Coble, 01080269, SAC
Engineer Officer	Maj Arthur J. Williams, Jr., 0329847, CE
Ass't Engr Off	Capt Ralph E. Donnelly, 0295341, CE
Inspector General	Lt Col Milton S. Bowman, 0162224, IGD
Judge Advocate	Lt Col Frederick H. Hauser, 0311403, JAGD
Ordinance Officer	1st Lt Godfrey S. Rice, 0387860, Ord
Quartermaster	Lt Col Albert A. Shumsky, 0301370, CAC
Ass't Quartermaster	Capt David A. Harrison, III, 01575346, QMC
Surgeon	Lt Col Harold F. Budington, 0162181, MC
Liaison Officer (3d ND)	Lt Col Edward J. Richards, 0241036, CAC 7th CA
	1st Lt Eugene J. Carey, 01080265, CAC 245th CA (ND)
	1st Lt James L. Johnston, 0397480, CAC
	1st Lt Gustave F. Sachers, 0163793, CAC 248th CA (ND)
Liaison Officer (4th ND)	Maj Ernest L. Small, 0123636, SAC
	Capt Clyde T. Hertz, 0162972, CAC
	2nd Lt. Frank D. Sharp, 01080964, SAC
Chief Clerk	C. L. O. LeRoy Paddock, W2103782

The units under command of New York-Philadelphia Sector at the beginning of February, the final days of Sector, and their stations, were as follows:

NEW YORK-PHILADELPHIA SECTOR

Hq and Hq Co. NYPB	Fort Hamilton, N.Y.
NYPB Sig Oper Det	Fort Hamilton, N.Y.
New York Subsector and Harbor Defenses of N.Y.	Fort Hancock, N.J.
Philadelphia Subsector and Harbor Defenses of Del.	Fort Miles, Del.
133th Inf. Regimental Combat Team	Fort Hamilton, N.Y.
Hq Co, 113th Inf & Med Det	Fort Hamilton, N.Y.
Service Co, 113th Inf	Fort Hamilton, N.Y.
Anti-Tank Co, 113th Inf	Camp Upton, N.Y.
Cannon Co, 113th Inf & Med Det	Freehold, N.J.
275th Army Band	Bethpage, N.Y.
1st Battalion, Hq Co & Med Det	Riverhead, N.Y.
Co A	Watermill, N.Y.
Co B	Bethpage, N.Y.
Co C	Camp Upton, N.Y.
Co D	Riverhead, N.Y.
2nd Battalion, Hq Co & Med Det	Georgetown, Del.
Co E	Bethany Beach, Del.
Co F	Tuckahee, N.J.
Co G	Port Republic, N.J.
Co H	Dias Creek, N.J.
3rd Battalion, Hq Co & Med Det	Eatontown, N.J.
Co I	Island Heights, N.J.
Co K	Eatontown, N.J.
Co L	Eatontown, N.J.
Co M	Eatontown, N.J.
40th QM Bn Mobile, Hq Det	Fort Dix, N.J.
3325th Truck Co	Fort Dix, N.J.
3326th Truck Co	Fort Dix, N.J.
3327th Truck Co & Med Det 40th QM Bn	Eatontown, N.J.
671st Cell Co (Sep)	Fort Hamilton, N.Y.

A strength report for Units under New York-Philadelphia Sector in its last days, dated 6 February 1944 was as follows:

<u>UNIT</u>	<u>OFFICERS</u>	<u>WARRANT OFFICERS</u>	<u>ENLISTED MEN</u>
Hq NY-Phila. Sector	36	1	146
Hq NY Subsector	5	1	26
Hq HD of New York	16	0	78
5th CA	32	4	661
7th CA	59	9	1229
245th CA	94	16	2409
288th (Ry) Bn	6	0	232
5th CAMP Btry (Ord)	1	7	39
12th CAMP Btry (Story)	2	7	50
20th CAMP Btry (Mayback)	2	7	53
Hq. Phila. Subsector	5	1	27
Hq HD of the Delaware	14	0	39
240th Army Band	0	1	25
21st CA	29	6	621
261st CA	28	3	586
287th CA (Ry) Bn	21	3	350
12th CAMP Btry (Sylvester)	2	8	49
19th CAMP Btry (Frank)	1	7	52
USAJMP Casey	1	2	13
113th Infantry	158	5	3059
275th Army Band	0	1	23
Sig Oper Det	1	0	81
40th QM Bn Mob	20	2	354
671st Col Co (Sep)	5	0	99
TOTALS	38	90	10,506

SECTION II  
Part 2

HARBOR ENTRANCE CONTROL POSTS and LIAISON  
(The Amagansett Affair)



DRAFT - HSCP

The Harbor Entrance Control Post is one of the new establishments incorporated in a harbor defense. Although missions similar to those assigned the Harbor Entrance Control Post have been carried out since men have battled for control of the sea and its harbors, it was the Harbor entrance Control Post of this war that made the accomplishment of these missions a study of combined operations in coastal surveillance.

As is the case in many other phases of Warfare, the speed of the modern weapons made a refinement of older methods imperative. The rapid exchange of information with almost simultaneous action as a result, was needed to meet the threat from undersea boat, surface craft or aircraft. This called for organization to the last detail for coordinated and swift action by both Army and Navy following the first indication of a threat to coastal security. It was the study of this problem that evolved the Harbor Entrance Control Post as the military man knows it today.

The basic or broad mission of the Harbor Entrance Control Post was laid down in the Joint Action Army and Navy, 1935, although the installation was not named as a Harbor Entrance Control Post. They are as quoted below, in part, from that document.

"The commander (Navy) of the Inshore Patrol, who will be stationed ashore, should have his headquarters located as conveniently as possible to the headquarters of the Harbor Defense Commander and at the same location if practicable. In any event he should be in direct communication with the HD Commander, as well as in direct connection with all naval activities in the defense coastal area.

".....For reports from elements of the Inshore Patrol, (Navy) the most direct communication is desirable by all available means from Naval elements to batteries, forts and command posts of the Army. A system of identification signals for all friendly Naval craft approaching defensive coastal areas must be established."

Following plans and studies made for an installation to meet the above requirements, the Army and Navy in the area of the Second Coast Artillery District (Sector area) reached the point by 1941 of holding extensive problems and tests of planned organization and location of Harbor Entrance Control Posts for the Harbor Defenses for New York and the Harbor Defenses of the Delaware. The system as basically conceived is much the same as the Harbor Entrance Control Post operation we know now, with refinements. Army and Navy Watch officers in the Harbor Entrance Control Posts represented their respective commanders for unity of action and had communication set-ups that connected them with all tactical elements of their respective commands. In Sector the Posts were located at Fort Wadsworth for New York and on Cape Henlopen for Delaware.

Early in 1941, the problem of the Harbor Entrance Control Post was being whipped into shape in earnest and the War Department moved to coordinate and standardize the effort. The first move was a statement of the "Mission, General Operation and Desirable Location of a Harbor Entrance Control Post." This Document was approved May 29, 1941 by H.R. Stark, Admiral U.S. Navy, Chief of Naval Operations, and on June 23, 1941 by George C. Marshall, General U.S. Army, Chief of Staff, U.S. Army. It read as follows:

"1. A harbor entrance control post is a central point for the coordination and joint operation of the Army and Navy elements of the harbor defense system, whose mission is:

**MISSION** - to collect and disseminate information of activities in the defensive sea area; to control unescorted commercial shipping in the defensive coastal area; and to take prompt and decisive action to operate the elements of the harbor defense; in order to deny enemy action within the defensive coastal area.

"2. This post is visualized as one continuously manned by an Officer of both the Army and Navy and the necessary assisting personnel for clerical and communication duties, where the Army and Navy Officers are the Senior Local Commanders of their respective services, or their direct representatives with authority to take the action necessary to accomplish the mission as stated above.

"3. When the Army or Navy Officer on duty at the Harbor Entrance Control Post is a representative of the Local Senior Commander, his authority will have to be defined by the Senior Officer whom he represents, whose judgement must be based upon the task which is to be accomplished as expressed in the mission.

"4. The ideal location for such a post is one which will command a complete view of the harbor approaches and the harbor itself. The ideal housing is to place it in the same building with the Army's harbor defense command post. Neither of these ideals can probably be uniformly realized at all points where Harbor Entrance Control Posts will be established.

"5. Each Harbor Entrance Control Post should be equipped with a chart room where information relative to enemy activities or other activities which are potentially important, may be plotted on a graf or situation map of the defensive coastal area; and with all of the communication facilities necessary to receive and disseminate information and to communicate with the elements of the harbor defense system. Wherever it is practicable it seems desirable, in order to eliminate as much communication installation as possible, to place in the harbor entrance control post building a receiving station for underwater listening posts, indicator loops and sono buoys and a visual signal station. This arrangement expresses an ideal which also probably cannot be uniformly realized, but to whatever extent such an arrangement is practicable, it seems desirable to make it so."

Another move was the organization and operation of Harbor Entrance Control Posts at eight locations and directed by the War Department in a letter from the Adjutant General's Office, dated October 2, 1941 sent to General Drum, commanding the First Army with headquarters then at Hoffman, North Carolina. The sites were named as:

Boston, Mass.; Newport, R.I.; Fort H.G.Wright, N.Y.; Fort Wadsworth, N.Y.; Cape Henlopen, Del.; Chesapeake Bay, Va.; Portland, Me.; and Portsmouth, N.H.

It was directed that existing facilities should be used to the full with minimum modifications to adapt them for the dual requirements of Harbor Defense Command and Harbor Entrance Control Posts. They were to be organized and operated on a training basis and prepared for operation on a war basis.

General Williford of the Second Coast Artillery District called upon the commanding officers of the Harbor Defenses of Southern New York and the Delaware to have plans and cost estimates at headquarters before October 25, 1941.

It was noted that the War Department directive "...supersedes previous instructions of local origin regarding the establishment of harbor entrance control posts in the Second Coast Artillery District." And that "...plans ....should be based upon the experience gained in the operation of the harbor entrance control post now installed in your harbor defense and not necessarily on previously submitted plans."

Within three months of this directive, and before the organization of the Harbor Entrance Control Posts had really been shaken down, the system was called upon to operate on a War Basis. The War Department in a letter of 23 December, 1941, file: AG 660.2 (12-20-41) WFO-E, directed the Commanding General, Northeast Defense Command, to place all Harbor Entrance Control Posts in his command on a War Basis.

This called for, among other things; projects and cost estimates, not previously submitted, covering new or supplementary facilities necessary to operation on a War Basis; full use of an examination battery, which will be kept in a suitable state of readiness at all times, and the maintenance of constant personal liaison by the Army officer on duty in the Harbor Entrance Control Post with the Navy officer on duty there.

A letter from the Chief of Coast Artillery, dated the next day, 24 December 1941 advised that the third supplemental National Defense Appropriation Act, 1942, had appropriated additional funds for the improvement of Harbor Entrance Control Posts. Included in the list was \$7256 for that at Fort Wadsworth in the then Harbor Defenses of Southern New York, and \$10,900 for that at Fort Miles, the Harbor Defenses of the Delaware. (Ref. 381/76)

As the HECOP functioned it continued to expand to meet the demands of the problems. Eventually the HECOP at Fort Wadsworth was operating with two sub-HECOP's, No. 1 at Fort Hancock and No. 2 at Fort Tilden. These sub-posts were

operated with troops of the fort garrisons and the Navy assigned Naval personnel for their operations. They were to all intents and purposed EEOCs but were not authorized as such since one Harbor Defense could have but one Harbor Entrance Control Post under the principles of Joint Action. Headquarters batteries of the Harbor Defenses manned the primary EEOCs at Forts Mifflin and Miles.

In addition to the Harbor Entrance Control Posts other Joint Operations and liaison centers were maintained to coordinate Army and Navy action. In a report of December 29, 1941 to Hq. Eastern Theater of Operations, Sector described its Joint Operations with Naval Districts as follows:

"The Joint Operations center of this sector and two Naval Districts involved consists of the liaison in the Joint Operations room at the headquarters of the North Atlantic Naval Coastal Frontier (Eastern Sea Frontier). A continuous watch is maintained at that Headquarters and the watch officer is charged with the obtaining of information concerning friendly and hostile naval craft operating in the coastal zone covered by this sector. He is likewise charged with the transmission of information concerning friendly naval craft to this Command Post (Sector) in code and in transmitting information relative to hostile craft in the clear. Information concerning the movements of friendly naval craft are evaluated at the Command Post and transmitted in code to the affected subsector commanders." (Ref. 370.26/100)

This arrangement was ended January 2, 1943 when Eastern Defense Command advised the New York-Philadelphia Sector that "the three officers from your Sector who have been detailed ..... with the EEO Liaison Section at ESF (Eastern Sea Frontier), 90 Church Street, are hereby relieved ..... as of 1200 this date."

With the closing of the EEO-ESF liaison agreement by which Sector and EEO shared information and joined forces in manning the liaison group, EEO set up its own liaison group independent of Sector and Sector set up another independent liaison group with 3rd Naval District, still at 90 Church Street, an arrangement that was still in effect in February 1944.

The Sector-3rd Naval District Liaison Group was opened on January 6, 1943

by three officers who had been on duty with the EDC-ESF Group. They were Major Daniel A. Hopper, 1st Lt. Edward S. Rice and 1st Lt. John A. Eriksen.

During this time the New York-Philadelphia Sector had been operating an independent liaison section in conjunction with the 4th Naval District (Philadelphia Subsector). For this purpose Sector had installed three officers in a Joint Operations Office at the Navy Operations Base, Cape May. The officers, Lt. Col. Edward J. Richards, 245th CA, Fort Hancock, N.J.; Major Ernest L. Small, 245th CA, Fort Hancock, and Capt. Stanley E. Karp, 21st CA, Fort DuPont, Delaware, were detailed to the "temporary duty" by Special Order No. 78, Hq. New York-Philadelphia Sector, dated May 29, 1942. These officers arrived and officially opened the Cape May Joint Operations Office on June 2, 1942. This Joint Operations office was still operating in February, 1944.

In addition Sector maintained Air Command liaison representatives at the New York and Philadelphia Regional Information Centers from shortly after the outbreak of the war, 13 December 1941 until 5 November 1943. When the "Army Leg" was closed and the duties of the Sector liaison group were taken over by the New York AAA Region and the Philadelphia AAA Region. This move was approved by Eastern Defense Command 11 October 1943 in a 1st Ind, on letter from New York Philadelphia Sector, 2 October 1943, subject: Enlisted Liaison Details, file: GS 322.881/19 x 320.

The reason for this action was the decrease in messages transmitted by these liaison agencies, and since: "A larger percentage of these messages were of a routine nature and were received from other sources. The shortage of personnel makes the relief of these details desirable ....."

Other liaison functions included those provided by troops of the Combat Team

manning the beach patrols with the Coast Guard stations. This information was gleaned in addition to the coastal intelligence obtained by the Army beach patrols themselves. It was the outgrowth of the realization that a close liaison chain from the lowest element of command to the highest was necessary if a prompt and accurate exchange of information was to be obtained. Generally these patrols were kept on the beaches only during the hours of darkness or during periods of low visibility caused by fog or when some specific danger was believed to exist for any one section of beach.

This information was funneled back to headquarters initially through the sub-sectors being empowered to use the Army forces (and the Navy forces through the cooperation of the Navy Commander) within the area of their commands to meet any apparent threat to the security of the coast. This arrangement remained in effect until the change in the territorial organization of troops was effected by Field Order No. 3, Hq. New York-Philadelphia Sector, 1 November 1943, when the Sector Mobile Force reported directly to Sector Headquarters.

To take care of this change in organization, Sector Mobile Force set up its own liaison center for the transmission of information from subordinate units coincident with the change, 0001, 1 November 1943.

A clearing house for the information supplied by all these sources had to be provided.

With the outbreak of the war the nerve ends of all the liaison installations was a group of phones in an office in the original Headquarters Building at Fort Hamilton. The phones were in the office of Col. Albert M. Jackson, then Plans and Training Officer, and subsequently S94 and Chief of Staff for General Homer. Staff officers, principally the then Major Paul A. Jacoard, Lt. Colonel John S. Mayer,

Major Paul A. Jaccard, Major Charles Crane, Capt. John Phillips, Captain James C. O'Connor, and others; collated and evaluated the messages as well as made decisions as to action required.

To ease the burden of detail imposed by this system in addition to regular staff duties, a system that in the early days went to the extent of including night calls being transferred to the bedside of the newly made Lt. Col. Crane, an "operation section" of enlisted men to handle a newly installed switchboard was organized and placed on duty March 12, 1942. The messages still went to staff members.

Then, in the summer of 1943, it was proposed to maintain an "Operations Room" including four officers to take over the duty of receiving and sifting the messages received through the switchboard by the operation section of enlisted men who up to that time continued to be responsible to staff members in the daytime and the staff duty officer at night. The Operations Room was made possible by the completion of the wing built on the rear of the original Headquarters Building to house the increased activities of Sector. The personnel, switchboard and other paraphernalia of "Operations" was moved to its own splinterproof room on the sub-floor of the wing by the end of June, 1943.

Meanwhile Capt. John A. Eriksen was called from his liaison duty at Third Naval District to head a group of duty officers who were originally 1st Lt. Donald McClellan, 1st Lt. Melvin Madans and 2nd Lt. Charles W. Wilson, Jr., in addition to Capt Eriksen. They took over their duties, after a period of indoctrination and experimentation, on July 1, 1943.

This system of operation proved a success and increased the efficiency and facility of handling Sector intelligence rapidly and smoothly. The "Operations



Room" continued in effect at Fort Hamilton until 1944 brought old Sector's expansion into the Southeastern Sector.

The importance of this system that was built up for the accurate and rapid interchange of intelligence between elements of coastal defense is perhaps best shown by the episode of Amagansett, the landing of enemy agents on the eastern shore of Long Island. Also it was the experience of the Amagansett affair that pointed out faults and contributed to the perfection of the system.

It was the so-called Amagansett Affair in which four German agents were landed on the east shore of Long Island June 13, 1942. This with the similar landing on Ponte Verde Beach, Fla., were the only known landings of enemy agents on American shores.

The landings of these agents is of interest because it involved a problem in beach patrol and one of coordination of effort of coast defense forces, especially, in this case, of Sector and its Combat Team on one hand and the Coast Guard on the other. The landing was successful in that the agents succeeded in landing on the beaches, hiding demolition and other material and boarding train or bus for travel into cities of the United States. It is of historical interest that the eight agents, four landed in each case, were subsequently captured by the FBI June 27 and executed, after a trial that excited nation-wide interest, on August 8, all in 1942.

Amagansett is 106 miles from New York City and the Amagansett station is about one mile from the beach. The landing of the agents was made about 300 yards east of the Coast Guard Station there but it is believed that the agents intended to land about a half mile west of the Station where the beach, being more deserted, offered a more favorable beach for such a landing. The men in the Amagansett

SECRET

landing were George John Dasch, leader, Ernest Peter Burger, Richard Quirin and Werner Thiel.

The details of the landing were this. Testimony of the agents indicated that the submarine came in on dead reckoning, submerged until she touched bottom, then surfaced and came straight in until the bow grounded. The sub then swung broadside to the beach, headed west. A rubber boat was launched and the demolition material was loaded. The boat was manned by the four agents and two sailors from the sub. A line was attached to the boat and payed out from the sub. After pushing off (about midnight), the boat was swung around by the swells but oriented by the sound of the surf and paddles straight in to shore. Demolition material was carried up to the beach and buried behind the dunes.

The job was completed about midnight when a coast guard patrolman approached from the Station. The agents testified that they hid <sup>?</sup> in the sub until daylight <sup>no</sup> then headed due north until they reached the Long Island Railroad where they walked west along the tracks to the Amagansett Station. At 0645 EWT they purchased tickets for New York. From this action it is indicated that they had a knowledge of the train schedule of the Long Island R.R. as the first train after midnight was the express to New York that stops at Amagansett at 0659 EWT. Suspicion was attracted to one agent because he splurged in buying himself a very expensive new outfit (clothes, luggage, Leica camera, etc). Through "tailing" this agent all the others were picked up including the contacts they made.

The general facts of the "landings" on Long Island are those above. The pertinent fact in the study of liaison operation in Sector is that there was a delay of two hours and fifteen minutes, more or less, in the transfer of that information to Army units. The most concise description of what happened is to

be found in the report of the S-2 of Sector who made an investigation of the delays. The report answered questions as follows:

"Why the delay of two hours and fifteen minutes in the receipt of this information?"

Investigation reveals that no detailed journal or log was kept at Coast Guard stations. Therefore it is not possible to fix the exact time of actions taken by the personnel there. The Coast Guard beach patrolman was accosted between 1220 a.m. and 1230 a.m. He returned to his station and reported the incident immediately, which would place the time between 1230 a.m. and 1245 a.m. The Napeague Coast Guard Station (Headquarters District Supervisor) was alerted about 1240 to 1250 a.m. The officer in charge at Napeague stated he advised the Coast Guard Duty Officer at Customs House "about 0100 a.m. (Time questionable.) The Coast Guard Intelligence Officer, New York District, states that they were informed at 0150 a.m. and transmitted the information to Inshore Patrol and Third Naval District. There is no record of Inshore Patrol advising Harbor Entrance Control Post, through which agency the tactical command could have been alerted. Eastern Sea Frontier (Navy) received a report from Coast Guard Intelligence at 0205 a.m., Eastern Sea Frontier received a similar report from office, Naval Intelligence, Third Naval District, at 0215 a.m. A written report, times 0220 a.m. was given to the Army Liaison Officer, Eastern Sea Frontier, about that time and was transmitted to the New York-Philadelphia Sector at 0230 a.m. This report was merely informatory and did not indicate a need for assistance, stating that Coast Guard and Navy were endeavoring to find the boat which had disappeared. The Staff Duty Officer, New York-Philadelphia Sector, transmitted the report to the S-2, New York Subsector, immediately, requesting investigation and full report of occurrence.

"Why was information not transmitted by the Coast Guard to the Sector Command through Coast Defense Warning System."

In their excitement the Coast Guard Personnel never thought of it. All of them were cognizant of the "Red Flash Messages" and the Chief Officer at Amagansett Coast Guard Station was cognizant of the directive to report to report to Army at Fort Hancock (Headquarters New York Subsector) through Rockaway Coast Guard Station.

"Why the R.D.F. information was not used to alert the combat team defending Eastern Long Island?"

Eastern Sea Frontier issues an Enemy Action Diary periodically in which are listed all R.D.F. "fixes." That given the Liaison Officer at Eastern Sea Frontier about 1140 p.m. included the R.D.F. report of a submarine at 40.30 N-72.00 W at 2053, with the additional note that "U.G. #187 proceeding to scene." This message was transmitted to the New York-Philadelphia Sector at 1141 p.m. the information about the Coast Guard Boat being changed to "Action being taken by Navy." This report was immediately transmitted by Staff Duty Officer, New York-Philadelphia Sector to Duty Officer at New York Subsector. No further action was taken by the Subsector because the time of the fix was 353 p.m. and because "Action being taken by the Navy" indicated off shore action. Before an alert to the Mobile Forces was indicated, it was assumed that, in accordance with previously arranged plans, a further warning would issue from Navy, giving a location or area if an attempted landing were expected. The reason for the delay between the receipt of the R.D.F. information by the Navy and its dissemination to the Army was due to Navy custom in handling such reports, the full details of which are not known at this (New York-Philadelphia Sector) headquarters.

It was further established that although the Coast Guard personnel were

aware of the location of the Combat Team's billet in Amagansett and the observation post maintained by this team on the beach about  $1\frac{1}{2}$  miles from the Coast Guard Station. They neglected to report the occurrence to them until a runner arrived at the observation post at 0255 a.m.

This ends the bald facts of the report by S-2 of the New York-Philadelphia Sector. It appears to indicate a number of cardinal points in the operation of a system of coastal defense which of necessity incorporates elaborate intelligence, and employs the use of units of separate commands.

In the first place, no matter how perfect the system, thorough training and indoctrination of personnel in the purpose and intent of the system is imperative. The entire system of coastal protection is built on the theory of vigilance of a thin line of outposts with a mobile force that can be speedily drawn to the point of danger or emergency. The failure to report immediately such a suspicious occurrence as that at Amagansett foiled the entire system. It might just as well not have been created.

The failure to report through the coastal warning system, is the failure of another channel of communication due to personnel. The explanation, "excitement" is a failure of training, the same training that makes a soldier obey orders in a combat area despite the confusion of battle. It also illustrates that no channel of communication can be neglected in the belief that "the other fellow gave it to them."

A third point was the failure to use an instrument "fix" as a warning signal, a signboard point to action. All such devices, mines, hydrophones, magnetic loops, etc., react to certain disturbances of the normal. They take no action, they issue no commands. The story they tell is the intelligent interpretation

SECRET

of the watch officer. In this case a "fix" 30 miles, at the most, off the shore of Long Island should have by no stretch of imagination been viewed with complacency even though "action taken by the Navy" was mistakenly a part of the message. Awaiting "arranged plans" does not fill the gap.

A further point here is the illustration of team work. "Navy action" should not mean a rest for the Army in so called off shore action. The Army should have been there to back up the Navy. The "let George do it" attitude has no place in joint operations.

On the whole the Amagansett affair appears to be one of the most valuable illustrations of the importance of the exchange of information in guarding a coastline and of the extreme value of the BECP system of combined operations of the Army and Navy. Undoubtly the "affair" was one of the factors in teaching a lesson that made the BECP more finished and efficient an implement of war and for that reason is given so much space here. Happily the lesson was taught without unfortunate results in this isolated case.

(75)

SECRET

SECTION II

(Part 3)

TROOPS OF SECTOR

SECRET

RECORDS OF  
HARBOR DEFENSE TROOPS

NEW YORK-PHILADELPHIA SECTOR

Assigned

5th CA (HD)  
7th CA (HD)  
21st CA (HD)  
52nd CA (RY)  
(287th & 288th Sep Bns)  
245th CA (HD)  
261st CA (HD)

Attached

265th CA (HD)  
(16 Feb. '43 to 16 Jan. '44)



HEADQUARTERS UNITS

Hq and Hq Company NYPS  
Fort Hamilton, N.Y.

The Headquarters and Headquarters Company, New York-Philadelphia Sector, North Atlantic Coastal Frontier, was activated 1 March 1942 at Fort Hamilton, N.Y. by authority of letter, War Department (AGO), file AG 320.2 (2-13-42) MR-M-C, subject: "Organization of Coastal Frontier Sector Headquarters, dated 19 February 1942 and activated per General Orders No. 19, Headquarters Eastern Theater of Operations and First Army, dated 28 February 1942.

Hq and Hq Detachment NYSS  
Fort Hancock, N.J.  
and  
Hq and Hq Detachment PSS  
Fort Miles, Del.

The Headquarters and Headquarters Detachments of the New York Subsector, Fort Hancock, New York, and the Philadelphia Subsector, Fort Miles, Delaware, subsectors of New York Philadelphia Sector, was activated by General Orders No. 16, Headquarters New York-Philadelphia Sector, dated 31 August 1943 by authority of War Department letter, file AG 320.2 (31 July 43) PE-A-M-C, 20 August 1943, subject: "Utilization of Personnel," and verbal orders Commanding General Eastern Defense Command and First Army, 31 August 1943. Activations effective 1 September 1943 in accordance with T/O & E 4-240-1S, dated 3 July 1943.

Hq and Hq Battery HDNY  
Fort Hancock, N.J.

The Headquarters and Headquarters Battery, Harbor Defenses of New York, was activated at Fort Hancock, New Jersey, by General Orders No. 5, Headquarters New York-Philadelphia Sector, dated 9 May 1942 on authority of 2nd indorsement, War Department, AG 660.2 (4-7-42) MC-E, dated 27 April 1942 on letter Headquarters New York-Philadelphia Sector, Mod. File 000, dated 7 April 1942.

Hq. and Hq. Battery HDD  
Fort Miles, Del.  
(Fort DuPont, Del.)

The Headquarters and Headquarters Battery, Harbor Defenses of the Delaware was activated, effective 1 April 1941, at Fort DuPont, Delaware, by General Orders No. 4, Headquarters Harbor Defenses of The Delaware, dated 31 March 1941, by authority of War Department letter, file Ag 520.2 (2-28-41) M (Ret) M-C, subject: "Constitution and activation of Harbor Defense Headquarters and Headquarters Batteries," dated 28 March 1941. (Ref. HDD 520.2/34)

Moved on "temporary basis" from Fort DuPont noon of 10 June 1942 by General Orders No. 4, same date, Hq. PSS and HDD, on verbal orders Commanding General, New York-Philadelphia Sector. This was made a permanent change of station in General Order No. 7, dated 25 July 1942, Hq. PSS and HDD on authority of War Department letter, file AG 370.5 (6-5-42) MS-E-M, subject: "Change of Station" dated 13 July 1942 and Hq. NYPS indorsement, dated 25 July 1942 on letter from EDC and FA, same subject, dated 19 July 1942.

<sup>FIFTH</sup>  
FIFTH COAST ARTILLERY (HD)  
(Type A Regiment)  
Fort Wadsworth, N.Y.

The regimental organization of the Coast Artillery Corps was reestablished under the provisions of General Orders No. 8, War Department, February 27, 1924 and General Orders No. 1, Coast Defenses of Southern New York, July 1, 1924, an effective as of midnight, June 30, 1924 when the 48th, 50th, 51st, 53rd, 54th, 55th, 56th, and 57th companies, Coast Artillery Corps, became respectively Batteries A, B, C, G, E, F, D and Headquarters Battery, 5th Coast Artillery. All components of the regimental Headquarters and Headquarters Batt . The station of activation was Fort Hamilton,

Battery A, 5th CA was activated at Fort Wadsworth, N.Y. August 1, 1940 by War Dept. authority AG 320.2 (7-10-40) M (Ret) M-C, July 20, 1940 and by GO No. 17, Hq. 2nd Corps Area, July 29, 1940.

Battery B, 5th CA was activated at Ft. Wadsworth, N.Y., January 15, 1941 by GO No. 5, Hq. 2nd Corps Area, dated January 15, 1941, by authority in AGO letter, AG 320.2 (11-15-40) M (Ret) M-C, dated December 16, 1940. \*

Battery D, 5th CA activated at Fort Hamilton, N.Y., January 15, 1941 by same GO No. 5 and authority as Battery B.

The Medical Detachment, 5th CA activated at Ft. Hamilton, N.Y., April 16, 1941, by GO No. 5, Hq. 5th CA, dated April 16, 1941, by authority contained in letter AG 320.2 (12-20-40) M (Ret) M-C, War Dept., December 26, 1940 and letter AG 221 (12-27-40) E, War Department, dated December 27, 1940.

Although a War Department letter (File AG 320.2 (1-7-41) M (Ret) M-C), dated January 13, 1941 authorized the activation of the Second and Third Battalions and Battery "K" of the 5th CA (HD), all HD of Southern New York in June 14, this authorization was never realized.

SEVENTH COAST ARTILLERY  
(Type "B" Regiment)  
Fort Tilden, N.Y.

Hq. Battery was activated 1 July 1924 at Fort Hancock, N.J., on War Department authority, General Order No. 8, War Department 1924.

Hq and Hq. Battery, 1st Bn. was activated 11 January 1941 at Fort Hancock, N.J., on War Department authority letter War Department, file AG 320.2 M (Ret) M-C, subject: "Activation of Units", dated 20 December 1940, and activated per General Order No. 1, 7th C.A., 11 January 1941.

---

\* NOTE - Battery "B" of the 5th CA was redesignated Battery "E" of the 7th CA and Battery "E" of the 7th CA was redesignated Battery "B" of the 5th CA, effective 10 January 1944 to Special Orders No. 221, Harbor Defenses of New York, dated 28 December 1943.

Battery A was activated July 1, 1924 at Fort Hancock, N.J. on War Department authority General Order No. 8, War Department 1924. Inactive 21 January 1930 on authority letter, TAGO, dated 6 January 1930. Reactivated at Fort Hancock, N.J., 1 July 1939, on authority letter TAGO, 26 June 1939.

Battery B was activated 1 July 1924 at Fort Hancock, N.J. on authority General Order No. 8, War Department 1924. Inactive 21 January 1930 on authority of letter TAGO, dated 6 January 1930. Reactivated at Fort Hancock, N.J., 1 July 1939, on authority TAGO, 26 June 1939.

Battery C was activated 1 August 1940 at Fort Tilden, N.Y. by General Order No. 17, Second Corps Area, 1940. Transferred to Fort Hancock, N.J. 11 January 1941, permanent change of station.

The 1st Battalion, 7th CA (HD) consisting of Hq. and Hq. Battery, 1st Battalion, Batteries A, B, and C was transferred without personnel and equipment from Fort Hancock, N.J. to Fort Tilden, N.Y., permanent change of station. \*

Personnel and equipment of the 3rd Battalion, 245th CA (HD), consisting of Hq. and Hq. Battery, 3rd Battalion, Batteries G, H, and I, was transferred without change of station to 1st Battalion 7th CA (HD) and redesignated Hq. and Eq. Battery, 1st Battalion and Batteries A, B, and C \*

Date of above redesignation, 20 September 1942, War Department authority letter AG 320.2 (8-24-42) Mr-M-Gn, TAGO, 27 August 1942, subject: "Transfer of Certain Coast Artillery Units." Redesignated per Special Orders No. 29, Hq. New York Subsector, dated 20 September 1942. Effective 23 September 1942.

---

- \*NOTE - This change of station amounted to a redesignation of the 1st Battalion, 7th CA (HD) as 3rd Battalion, 245th CA (HD) and vice versa without change of station of personnel and equipment. See same under 245th CA (HD) records.

SEVENTH COAST ARTILLERY (Contd.)

Hq. and Hq. Battery, 2nd Battalion was activated 11 January 1941 at Fort Tilden, N.Y. by War Department authority letter, War Department, file AG 320.2 M (Ret) M-C, subject: "Activation of Units", dated 20 December 1940, activated by General Order No. 1, 7th CA, 11 January 1941.

Battery D was activated 1 July 1924 at Fort Hancock, N.J. on War Department authority General Order No. 8, War Department 1924. Inactive 11 January 1930 by authority of letter TAGO, dated January 1930. Reactivated 11 January 1941 at Fort Tilden, N.Y., by authority of letter, War Department, file AG 320.2 M(Ret) M-C, subject: "Activation of Units", dated 20 December 1940. Returned to Fort Tilden, N.Y. from temporary change of station at Fort Hamilton, N.Y. on 23 May 1942. Departed from Fort Tilden, N.Y. and arrived at Fort Hamilton, N.Y. on (9 September 1942. Temporary change of station. Returned to Fort Tilden, N.Y. from Fort Hamilton, N.Y. on 10 October 1942. Permanent change of Station.

Battery E was activated 1 July 1924 at Fort DuPont, Del., by War Department authority, General Order No. 9, War Department 1924 and inactivated at Fort DuPont, date and authority unrecorded. Reactivated at Fort Hancock, N.J. 13 January 1941 by authority of WD letter, file AG 320.2 M(ret) M-C, 20 December 1940. Transferred to Fort Tilden, N.Y., 17 March 1941, permanent change of station. Transferred to Fort Totten, N.Y., 10 April 1940, temporary change of station. \*

Battery F was activated 13 January 1941 at Fort Hancock, N.J. by War Department letter, file AG 320.2 M(Ret)M-C, dated 20 December 1940. Transferred to Fort Tilden, N.Y., 17 March 1941, permanent change of station.

Battery G was activated 1 June 1941 at Fort Tilden, N.Y. on authority War Department letter, file AG 320.2 (4-24-41)M(Ret)M-C, subject: "Constitution and Activation of Units", dated 25 April 1941. Activated by paragraph 1,

General Order No. 15, Hq. 2nd Corps Area, 22 May 1941, and paragraph 6, Special Order No. 58, Hq. 7th CA, dated 24 May 1941.

The Medical Detachment was activated 11 January 1941 at Fort Hancock, N.J. authority War Department letter, file AG 320.2 M(Ret)M-C, subject: "Activation of Units", dated 20 December 1940. Activated by General Order No. 1, 7th CA dated 11 January 1941. Transferred to Fort Tilden, N.Y. 23 September 1942 by Special Order No. 29, Hq. New York Subsector, Fort Hancock, N.J., dated 20 September 1942, permanent change of station.

TWENTY-FIRST COAST ARTILLERY  
(Type B Regiment)  
Fort Miles, Del.

(Ref. 320.2/789 NYPS files)

The activated components of the 21st Coast Artillery Regiment (HD) (Type B), according to 21st CA Headquarters report of 16 January 1943, consist of:

Regimental Hq. (minus Band)  
Headquarters Battery  
Battery A (mine Battery)  
Battery B (mine Battery)  
Battery C (gun Battery)  
Medical Detachment (minus Hq. Section)

Battery "E" of the Seventh Coast Artillery, Fort DuPont, Del., was rendered inactive and redesignated as Hq. and Hq. Battery, 21st CA per letter AG 320.2 (12-15-39), War Department AGO, dated February 1, 1940, subject: "Reorganization of Certain Coast Artillery Units." The station of activation was Ft. DuPont, Del.

Battery A, 21st CA was activated on August 1, 1940, at Ft. DuPont, Del., per Special Orders No. 17, Hq. Second Corps Area, dated August 1, 1940.

---

\* NOTE- Battery "E" of the 7th CA was redesignated Battery "B" of the 5th CA, and Battery "B" of the 5th CA was redesignated Battery "E" of the 7th CA, effective 10 January 1944 according to Special Orders No. 221, Harbor Defenses of New York, dated 28 December 1943.

Batteries B and C, 21st CA were activated on January 13, 1941 at Fort DuPont, Del., per Special Orders No. 6, Hq HED, Fort DuPont, Del., dated January 12, 1941.

THE Medical Detachment, 21st Coast Artillery was activated March 25, 1941 at Fort DuPont, Del., per Special Orders Number 13, Hq. HED, Fort DuPont, Del.

Yet to be activated as of January 16, 1943.

Hq. and Hq. Btry., 1st Bn.  
2nd Battalion  
Searchlight Battery

(Ref. 320.2/172 2nd CAD files)

In a War Department letter - File, AG 320.2 (1-7-41) M(Ret)M-C, dated Jan. 13, 1941 Hq. and Hq. Battery, 1st Bn, 2nd Bn and Battery "G" (SLF) of the 21st CA (HD) at the Harbor Defenses of the Delaware, then with headquarters at Fort DuPont, Del., were authorized but this authorization was never realized as in the case of the 5th CA organization of Second and Third Battalions and Battery "K".

Permanent change of station of the 21st CA from Fort DuPont, Del., to Fort Miles, Del., was authorized per Paragraph No. 1, General Orders No. 7, Hq. PSS and HDD, dated July 25, 1942.

Regimental Day for the 21st CA was selected as 21 February since the "first assembly in ranks of the formed organization of this Regiment occurred on 21 Feb. 1941" according to letter, Headquarters 21st CA dated 6 February 1942. Approved by War Department, AGO, indorsement dated 25 February 1942.

52nd COAST ARTILLERY - RAILWAY  
Fort Hancock, New Jersey

and the  
285th Coast Artillery (RY) Battalion  
286th Coast Artillery (Ry) Battalion  
287th Coast Artillery (Ry) Battalion  
288th Coast Artillery (Ry) Battalion

On February 5, 1918, the 52nd Artillery (C.A.C.) was redesignated from the

7th Regiment (C.A.C.) consisting of Hq. Btry. and Service Btry., Batteries "A", "B", "C" and "D". No record of authority or place of activation is on file at 52nd CA Headquarters.

The 52nd Coast Artillery (Ry) was reorganized in France on August 6, 1918 per General Orders No. 116, G.H.Q., A.E.F., dated July 15, 1918, consisting of 3 Battalions, Hq. Btry. and Service Btry. as indicated below:

Battery "A"  
Battery "B"  
Battery "C"  
Battery "D"  
\*Battery "E"  
\*Battery "F"

The 1st Battalion, consisting of Batteries "A" and "B" was made inactive on August 1, 1922, per letter, W.D., AG 320.2, dated July 18, 1922.

The Band was separated from the Service Battery and established as a separate component of the Regiment as directed in letter, .D., AG 322.94, dated June 22, 1927.

Service Battery, 52nd CA was placed on an inactive status while at Fort Eustis, Va., on February 28, 1930 with nominal station at Hq. 3rd Corps Area.

During March, 1930, the 52nd CA (Ry) less the 1st Battalion Service Battery and the 3rd Battalion, was ordered to Fort Hancock, N.J., which consisted of the following Batteries:-

Hq. and Hq. Btry.  
Band  
Battery "C"  
Battery "E"

At the same time Batteries "D" and "F", composing the 3rd Battalion of the 52nd CA (Ry), were ordered to Fort Monroe, Va.

---

\* NOTE - Batteries "E" and "F" were formed at that time from Batteries "I" and "K" of the 53rd Artillery Regiment (C.A.C.).



The Band was transferred to Fort Hancock, N.J., less personnel and equipment. Personnel for the Band were transferred from the 7th CA upon arrival at Fort Hancock, N.J.

Battery "F", 52nd CA (Ry) was rendered inactive on February 1, 1940, at Fort Monroe, Va., in accordance with letter, A.G. 320.2 (12-15-39) M (RET), M-C, Subject: "Reorganization of Certain Coast Artillery Units", dated January 19, 1940, and General Orders No. 2, Headquarters Third Corps Area, Baltimore, Md., dated January 24, 1940.

There was no record in 52nd CA Headquarters rendering Battery "D", 52nd CA (Ry) inactive while at Fort Monroe, Va.

The following units of the 52nd Coast Artillery (Ry), were activated at Fort Hancock, New Jersey, effective on January 8, 1941, in accordance with letter, W.D., TAGO, File AG 320.2 (12-20-40) M (RET), M-C, Subject: "Activation of Units", dated December 26, 1940, and General Orders No. 2, Headquarters 52nd CA (Ry), dated January 8, 1941:

Second Battalion  
Hq. and Hq. Btry. 2nd Bn.  
Battery "D"  
Third Battalion  
Hq. & Hq. Btry. 3rd Bn.  
Battery "F"

Battery "C" already active and stationed at Fort Hancock, N.J., was assigned to the 2nd Battalion, 52nd CA (Ry) effective January 8, 1941 and Battery "E", already active and stationed at Fort Hancock, N.J., was assigned to the 3rd Battalion, 52nd CA (Ry), effective January 8, 1941.

The 1st Battalion, 52nd CA (Ry) consisting of the following units, was activated at Fort Hancock, N.J., by General Orders No. 15, Headquarters 52nd CA (Ry) dated May 31, 1941, pursuant to authority contained in General Orders No. 15,

Headquarters 2nd Corps Area, Subject: "Constitution and Activation of Units",  
dated May 22, 1941:-

Hq. & Hq. Btry. 1st Bn  
Battery "A"  
Battery "B"

The 1st Battalion, 52nd CA (Ry) consisting of the following units (less personnel and equipment) was transferred from the Hawaiian Department to Fort Hancock, N.J., on February 5, 1942, per letter, WD, TAGO (Secret) File AG 320.2 (12-16-41) MR-M-C, dated February 5, 1942:-

Hq. & Hq. Btry. 1st Bn.  
Battery "A"  
Battery "B"

The 1st Battalion, 52nd CA (Ry) including the above named organizations, was formerly placed on DS in the Hawaiian Department, per letter (Secret) Eastern Defense Command and First Army, File G-3 (AG) 370.5, dated December 13, 1941.

Battery "D", 52nd CA (Ry) (less personnel and equipment) was transferred from the Newfoundland Base Command to Fort Hancock, N.J., on February 5, 1942, per letter WD, TAGO (Secret) File AG 320.2 (12-16-41) MR-M-C-, dated February 5, 1942.

Battery "D", 52nd CA (Ry) was formerly placed on DS in the Newfoundland Base Command per letter, WD, Headquarters 2nd Corps Area (Secret, File 320.2 AGO-Misc Div, dated April 11, 1941.

Battery "F", 52nd CA (Ry) (Less personnel and equipment) was transferred from the Base Command on January 28, 1942, per letter (SECRET), WD, TAGO File AG 320.2 (1-9-42) Mr-M-C, dated January 23, 1942.

Battery "F", 52nd CA (Ry) was formerly placed on DS in the Bermuda Base Command per letter (Secret, WD, TAGO File AG 320.2 (4-9-41), M-C-M, dated April, 9, 1941.

Battery "G", 52nd CA (Ry), (Searchlight Battery), was activated at Fort Hancock, N.J., on January 20, 1943, per Par. 2, General Orders No. 2, this Headquarters, dated January 20, 1943, in accordance with 2nd Ind., Headquarters New York-Philadelphia Sector, File AG 320.2/786 (490), dated January 15, 1943, on letter, WD, (Restricted), TAGO, File AG 320.2 (1-9-43) OB-IGN-M, dated January 12, 1943, Subject: "Activation of Battery "G", 52nd CA (Ry)".

The Medical Detachment, 52nd CA (Ry), was activated at Fort Hancock, N.J., on April 15, 1941, pursuant to Par. 1, General Orders No. 11, this Headquarters, dated April 15, 1941, in accordance with letter, WD, TAGO, File AG 320.2 (12-30-40) M (RET) M-C, Subject: "Activation of Units", dated December 26, 1940, and letter WD, TAGO, File AG 221 (12-27-40)E, Subject: "Allotments of Grades and Ratings for Enlisted Men, and Authorized Recruiting Strengths", dated December 27, 1940.

The 52nd Coast Artillery (Ry) disappeared as such in April and May, 1943 when the units, scattered on both coasts of the United States and at overseas stations, was reorganized and split into four separate Coast Artillery (Ry) Battalions, the 285th CA Bn (Ry); the 286th CA Bn (Ry); the 287th CA Bn (Ry); and the 288th CA Bn (Ry), less Headquarters and Headquarters Battery and Battery "B".

The reorganization was initiated by the Sector Command, GO No. 8 April 22, 1943, upon directions of the War Department in a letter April 5, 1943.

The First Battalion of the 52nd CA, (Ry), under command of the Chesapeake Bay Sector at Fort John Custis, Va., was redesignated the 286th CA, Bn. (Ry) and made up of the following units.

Hq. and Hq. Battery, 1st Bn, 52nd CA (Ry) redesignated Hq. and Hq. Battery, 286th CA Bn. (Ry).

SECRET

Battery "A", 52nd CA (Ry) redesignated Battery "A", 286th CA Bn. (Ry).

Battery "B", 52nd CA (Ry) redesignated Battery "B", 286th CA Bn. (Ry).

One platoon of Battery "G", 52nd CA (Ry) became the organic searchlight platoon of Hq. and Hq. Battery, 286th CA Bn. (Ry).

The Second Battalion of the 52nd CA (Ry), in the Harbor Defenses of the Delaware, under the command of the New York-Philadelphia Sector, at Fort Miles, Delaware, was redesignated the 287th CA Bn. (Ry) and made up of the following units:

Hq. and Hq. Battery 2nd Bn., 52nd CA (Ry) redesignated Hq. and Hq. Battery, 287th CA Bn., (Ry).

Battery "C", 52nd CA (Ry) redesignated Battery "A", 287th CA Bn. (Ry).

Battery "D" 52nd CA (Ry) redesignated Battery "B", 287th CA Bn. (Ry).

One platoon of Battery "G", 52nd CA (Ry) became the organic searchlight platoon of Hq. and Hq. Battery, 287th CA Bn. (Ry).

The Third Battalion of the 52nd CA (Ry) in the Harbor Defenses of New York at Fort Hancock, under the command of New York-Philadelphia Sector, was redesignated the 288th CA Bn (Ry) with all elements inactive except the Searchlight platoon and Battery "A".

Hq. and Hq. Battery, 3rd Bn. 52nd CA (Ry) redesignated Hq. and Hq. Battery, 288th CA Bn. (Ry). The Searchlight Platoon only was activated and that was attached to Battery "A".

Battery "E", 52nd CA (Ry), then on detached service with the Western Defense Command, was transferred to the 285th CA Bn (Ry) and redesignated Battery "A", 285th CA Bn., (Ry).

Battery "F", 52nd CA (Ry) was redesignated Battery "A" 288th CA Bn (Ry).

Battery "X", 52nd CA (Ry), and extra battery designation, was redesignated Battery "B", 285th CA Bn. (Ry) assigned to the Western Defense Command.

Thus, out of the former 3rd Bn, 52nd CA (Ry) came the 285th CA Bn. (Ry), Batteries "A" and "B" from Batteries "E" and "X" assigned to the Western Defense

Command while Battery "2" of the 3rd Bn. became a separate battery, 238th CA Bn. (Ry), at Fort Hancock, N.J., with a searchlight platoon from the former Battery "4", 3rd Bn. attached.

Concurrently with the reorganization and redesignations the Hq. and Hq. Battery and Battery "4" of the 52nd Coast Artillery (Ry) were disbanded. Also the Hq. and Hq. Battery, less searchlight platoon, and Battery "3", both of the 298th CA Bn. (Ry) were inactivated.

In addition the band of the 52nd Coast Artillery (Ry) was redesignated The Band, 31st Coast Artillery (HD) and was ordered moved to Key West Barracks, Fla.

The reorganization of elements within the New York-Philadelphia Sector were ordered effective May 1, 1943. (Ref. 320.2/814/815)

245th COAST ARTILLERY (HD)  
(Type "C" Regiment)

The 245th Coast Artillery, National Guard (New York), was inducted into active duty on 16 September 1940, the Regiment consisting of the following units at the time of induction at Fort Hancock, N.J.

Hq. and Hq. Battery; Hq. and Hq. Battery, 1st Battalion; Batteries A, B and C; Hq. and Hq. Battery 2nd Battalion; Batteries D, E and F; Hq. and Hq. Battery 3rd Battalion, Batteries G, H and I; Hq. and Hq. Battery 4th Battalion, Batteries K, L, M; Searchlight Battery (later designated Battery N), Band and Medical Detachment.

Authority Executive Order No. 9530, 31 August 1940, and letter War Department AGO, 4 September 1940 - file AG 225 (9-30-40) M-M and by letter, Headquarters Second Corps Area, 13 September 1940 - file 370.1 - subject "Concentration of National Guard Units".

The 3rd Battalion, 245th CA (HD), consisting of Hq. and Hq. Battery, 3rd Battalion, Batteries G, H and I, was transferred without personnel and equipment from Fort Tilden, New York, to Fort Hancock, New Jersey. Permanent change of station.\*

Personnel and equipment of the 1st Battalion, 7th CA (HD), consisting of Hq. and Hq. Battery, 1st Battalion; Batteries A, B and C were transferred without change of station to 3rd Battalion, 245th CA (HD) and redesignated Hq. and Hq. Battery 3rd Battalion; Batteries G, H and I. \*

Date of above redesignation 20 September 1942, WD Authority letter AG 320.2 (8-24-42) MR-M-ON, TAGO, 27 August 1942, subject: "Transfer of Certain Coast Artillery Units." Redesignated per Special Orders No. 29, Hq. New York Sub-Sector, dated 20 September 1942.

---

\*NOTE - This change of station amounted to a redesignation of the 3rd Battalion, 245th CA (HD) as 1st Battalion, 7th CA (HD) and vice versa without change of station of personnel and equipment. See same under 7th CA (HD) records.

SECRET

261st COAST ARTILLERY (SEP) BATTALION (HD)  
Fort Miles, Del.  
(and 122nd Coast Artillery (Sep)  
Battalion (AA) (Guns)

The 261st Coast Artillery was a Type "B" Regiment, National Guard of New Jersey and Delaware but was redesignated 261st CA (Sep) Bn (HD) 24 January, 1941 by letter Second Corps Area to Commanding Officer, 261st CA, Armory, Dover, Del., authority War Department letter - file AG 325,4 (12-4-40) M-C. The remainder of the authorized strength was redesignated 122nd CA (Sep) Bn (AA) (Guns) by the same authority.

The 261st CA (Sep) Bn (HD), (Type "D"), was inducted into Federal Service 27 January 1941 at Fort DuPont, Delaware on authority Executive Order No. 9627 dated 4 January 1941 per War Department Bulletin No. 1, Section II, dated 22 January 1941 and activated by letter dated 12 January 1941, file 325.36 AGO-Misc Div HQ 2nd Corps Area, Governor's Island, N.Y., Subject: "Concentration of National Guard Units to be inducted on 27 January 1941.

The movement of the 261st CA to Fort DuPont was ordered begun and completed on 30 January 1941 by motor. Advanced detachments by rail departed and arrived 31 January while the main bodies that were to move by rail departed and arrived 4 February 1941.

265th COAST ARTILLERY (HD)  
(Type B Regiment)  
Ft. Hancock, N.J.

The War Department (AG 322 (14 Jun '43) OB-I-GNGCT-M) authorized the transfer of the 265th Coast Artillery, (HD) from the XIII Corps to the eastern Defense Command for administration and training, at present station, Fort Hancock, N.J., effective on 19 June 1943. The assignment of the unit to the Army Ground Forces remained unchanged. Former station was Fort Jackson, South Carolina.

Lieut. Gen Drum of the Eastern Defense Command and First Army ordered the attaching of this unit to the New York-Philadelphia Sector and Sector attached the unit to the Harbor Defenses of New York, all effective 19 June, 1943.

The 265th CA (HD) arrived 16 February 1943 (with 63 officers and warrant officers, and 1305 enlisted men) at Fort Hancock. On 18 February 1943 a letter, Hq. XIII Corps, Providence, Rhode Island, directed that "that this unit prepare for overseas service" training to be complete 1 May 1943. The Regiment departed 11 January for the Seattle Port of Embarkation and arrived at the PE 16 Jan. 1944, passing from attachment to New York-Philadelphia Sector.



## MINE PLANTER BATTERIES

FIFTH COAST ARTILLERY MINE PLANTER BATTERY (USAMP "Ord") was originally activated as Detachment CAC, USAMP, General E.O.C. Ord, was redesignated 30 November 1942 at Fort Hancock, New Jersey, authority War Department letter AG 320.2 (11-15-42) OB-I-GN-M, dated November 1942 by 3rd indorsement, Headquarters Harbor Defenses of New York, Fort Hancock, N.J., file 320/11 x 560-HD (A660), dated 25 November 1942.

TWELFTH COAST ARTILLERY MINE PLANTER BATTERY (USAMP "Sylvester") was activated 19 August 1942 at Point Pleasant, West Virginia, by 1st indorsement War Department, AGO, file Ag 221 (8-4-42) EA-SFGA dated August 1942 to Immediate Action Letter, Headquarters Army Ground Forces, War College, Washington, D.C., subject: Crew for U.S. Army Mine Planter Sylvester," dated 4 August 1942. Redesignated 20 November 1942 to Fort Miles, Delaware, by instructions letter AG 320.2 (11-13-42) (Secret) OB-I-GN-M dated 15 November 1942, subject: "Redesignation of Coast Artillery Mine Planter Units."

FIFTEENTH COAST ARTILLERY MINE PLANTER BATTERY (USAMP "Story") was activated 8 October 1942 at Point Pleasant, West Virginia, War Department authority letter AGO dated 8 October 1942, file AG 220.31 (10-5-42) FE-A, as Detachment CAC, USAMP Story. Redesignated 15th CAMP Battery 15 November 1942 by War Department letter, file AG 320.2 (11-13-42) TAGO 15 November, Subjects: "Redesignation of Coast Artillery (Cableship) Units."

NINETEENTH COAST ARTILLERY MINE PLANTER BATTERY (USAMP "Frank") was activated 28 November 1942 at Fort Hancock, New Jersey by War Department, AGO, letter, file AG 320.2 (11-16-42) OB-I-GN-M, subject: "Organization of Coast Artillery Mine Planter Batteries," dated 18 November 1942 and by General Orders No. 16, Headquarters 245th CA, Fort Hancock, N.J., dated 28 November 1942.

TWENTIETH COAST ARTILLERY MINE PLANTER BATTERY (USAMP "Mayback") was activated.

TWENTY-SECOND COAST ARTILLERY MINE PLANTER BATTERY (\*) was activated 9 Jan. 1943 at Fort Hancock, New Jersey authority War Department, AGO, letter, dated 21 December 1942, file AG 320.2 (11-18-42) OB-I-GN-M, subject: "Constitution and Activation of Certain Coast Artillery Mine Planter Batteries," and by General Orders No. 6, Headquarters 245th CA, Fort Hancock, N.J., dated 9 Jan. 1943.

---

\*NOTE - The Twenty-Second Coast Artillery Mine Planter Battery was attached to the USAMP "Ord", Fort Hancock, N.J. and transferred to the USAMP "Bundy" Point Pleasant, West Virginia, 22 February 1943.

MISCELLANEOUS UNITS

151st STATION HOSPITAL

The 151st Station Hospital was activated 1 June 1941 at Fort Hancock by General Orders No. 15, Headquarters Second Corps Area, dated 22 May 1941 on authority War Department letter, AGO, dated 25 April 1941.

275th ARMY BAND  
(Band, 113th Infantry)

The 275th Army Band was created by the reorganization and redesignation of the 113th Infantry. (See under "Records of Regimental Combat Team"). The 275th Army Band was assigned to the New York-Philadelphia Sector with permanent station at Fort Hamilton, New York and attached to the 113th Infantry with temporary station at Bethpage, Long Island, New York, concurrently with the reorganization and redesignation effective 13 December 1943.

240th ARMY BAND  
(Band, HD of the Delaware)  
(Band, 119th Medical Regiment)

The Band, 119th Medical Regiment, redesignated on 16 February 1942, the Band, Harbor Defenses of the Delaware, was directed to report at Fort DuPont, Delaware, on or about 19 March 1942 from Camp Claiborne, Louisiana by Special Orders, No. 69, Hq. Camp Claiborne, dated 18 March 1942 under authority War Department letter, file AG 320.2 (3-6-42) MC-C-M, dated 16 March 1942 and 1st Indorsement, Hq. Fourth Corps Area, 370.5 - General - RS (3-16-42), dated 16 March 1942.

The Band, HD of the Delaware, moved from Fort DuPont, Delaware, to Fort Miles, Delaware, 15 July 1942, leaving and arriving the same day.

The Band, HD of the Delaware, was reorganized effective 3 January 1944, in accordance with Column 2, T/O 5-21, 1 April 1942, with an authorized strength of one Warrant Officer and twenty-eight enlisted men pursuant to authority War Department letter, file AG 322 (24 Dec '43) OB-I-GNGCT&M, dated 28 December 1943. Subject: "Reorganization and Redesignation of Bands," and 1st Indorsement, Hq. Eastern Defense Command, C-3 - 321/Bands, 31 December 1943. Concurrently with the reorganization the Band, HD of the Delaware, was redesignated as the 240th Army Band and was assigned to the Harbor Defenses of the Delaware with permanent station at Fort Miles, Delaware. This was directed by General Orders No. 1, Hq. New York-Philadelphia Sector, dated 3 January 1944.

---

RECORDS OF  
REGIMENTAL COMBAT TEAM  
(113th Infantry and Attached Units)

NEW YORK-PHILADELPHIA SECTOR

COMMANDING OFFICERS  
of the  
113th INFANTRY  
since  
Induction

-0-

<u>NAME, RANK, AND SERIAL NUMBER</u>	<u>ASGD TO COMMAND</u>	<u>RELD OF COMMAND</u>	<u>PROMOTIONS DURING COMMAND</u>	<u>STATUS 1 FEB. 1944</u>
Lt. Col. FREDERICK S. TAGGART 0161085 (NGUS)	8 Sep 40	6 Oct 40	---	Deceased 11 Mar 41
Colonel JULIUS O. ADLER 0101898 (RES)	7 Oct 40	13 Jul 41	---	Brig. General
Lt. Col. PAUL M. CAIRNS 0221610 (NGUS)	14 Jul 41	4 Oct 41	---	C.O., 3rd Bn.
Lt. Col. MANTON S. EDDY 04655 (R.A.)	5 Oct 41	11 Dec 41	To Col.	Maj General
(Became New York-Philadelphia Sector Regimental Combat Team under these commands)				
Col. NORMAN H. SCHWARZKOPF 0190484 (NGUS)	12 Dec 41	2 Jul 42	---	Brig. General
Lt. Col. GILBERT S. BROWNELL 03886 (R.A.)	2 Jul 42	16 Mar 43	To Col.	Retired
Lt. Col. VINTON L. JAMES 06924 (R.A.)	16 Mar 43	20 Mar 43	---	Colonel Fort Comdr. (Hwfld)
Colonel HARRY D. SCHEIBLA 010107 (R.A.)	21 Mar 43	---	---	---

-0-

113th INFANTRY COMBAT TEAM  
Fort Hamilton, New York

The 113th Infantry, New Jersey National Guard (consisting of a Headquarters Company, Service Company, Medical Detachment, 3rd Battalion Headquarters Detachment, 3 Heavy Weapons Companies and 9 Rifle Companies) was inducted into active Federal Service at Newark, N.J. with the 44th Infantry Division per executive Order No. 8530 dated August 31, 1940 and effective September 16, 1940.

The Anti-Tank Company was formed from the Anti-Tank Platoon of Headquarters Company at Fort Dix, N.J. on January 6, 1941 in accordance with General Order No. 2, Hq. 44th Infantry Division dated January 4, 1941 and T/O 7-11 dated October 1, 1940.

One Battalion, 113th Infantry Combat Team (2nd Battalion) ordered to move "without delay" from Fort Dix, to vicinity of Georgetown, Delaware, and the 113th Infantry less detachments with one battery of light Field Artillery and one company combat engineers to vicinity of Freehold, N.J. reporting on arrival to Commanding General, New York-Philadelphia Sector, Fort Hamilton, New York, for temporary duty - Movement Orders No. 505, Hq. First Army, 16 December 1941. Conforming with Par. 4 f. (4) (b), DP NET-41 and Par. 3 a. (2), Annex 1, DP JNYPS-41.

The movement was described in a report of the Commanding Officer, Colonel H. Norman Schwarzkopf, dated 17 February 1942 to Sector as follows:

The 1st Battalion left Fort Dix, N.J., December 11, 1941 and arrived Mitchel Field, Long Island, December 12, 1941. Company C, left Mitchel Field, Long Island, N.Y., December 14, 1941 and arrived Camp Upton, Yaphank, L.I., N.Y. on December 14, 1941.

The 2nd Battalion left Fort Dix, N.J., December 15, 1941 and arrived Georgetown, Delaware December 16, 1941, less Company F, detached enroute, which arrived at Cape May Naval Station, December 16, 1941.

Company R, left Cape May Naval Station and arrived Cold Springs, N.J. December 18, 1941.

Company F, left Cold Springs, N.J. and arrived at Woodbine, N.J., February 10, 1942.

The 3rd Battalion left Fort Dix, N.J., December 15, 1941 and arrived Collingswood Park, N.J., December 16, 1941..

Left Collingswood Park, N.J., December 20, 1941 and arrived at Eatontown, N.J. December 20, 1941.

The Headquarters Section of the 113th Infantry left Fort Dix, N.J. and arrived in Freehold, N.J., December 15, 1941.

Left Freehold, N.J., and arrived in Fort Hancock, N.J., December 23rd, 1941.

On April 1, 1942 when the new Tables of Organization were published the three Battalion Headquarters Detachments were reorganized and activated into Battalion Headquarters Companies.

The Headquarters, 113th Infantry at Fort Hancock, New Jersey was closed as of 2400, 18 March 1943 and opened at Fort Hamilton, New York as of 0001, 19 March 1943 by General Orders No. 3, New York-Philadelphia Sector dated 18 March 1943.

The Cannon Company, 113th Infantry was activated by General Orders No. 8, New York-Philadelphia Sector, dated 4 September 1943. The authority was letter of War Department, file AG 322 (7 August 1943) OB-I-GNCOF-M, 10 August 1943, title: Reorganization of Infantry Regiment under new T/O & Equipment, 7-14, 15 July 1943." The Cannon Company was activated with station at Freehold, New Jersey and with assignment to the 113th Regimental Combat Team.

The 113th Infantry Regiment with Headquarters at Fort Hamilton, New York was reorganized under T/O and equipment 7-11, dated 15 July 1943 by General Orders No. 9, New York-Philadelphia Sector, dated 10 September 1943. War Department authority same as above for Cannon Company, 113th Infantry.

The Band, 113th Inf., reorganized and redesignated the 275th Army Band, authority War Department letter, file AG 322 (27 Nov 43) OB-I-GNCOF-M, 1 December 1943, subject "Constitution, Activation, Reorganization and Redesignation of Bands" and 1st Ind., Hq. Eastern Defense Command, G-s - 322, 8 December 1943, and directed by General Orders No. 21, Hq. New York-Philadelphia Sector, dated 9 December 1943 and effective 13 December 1943. The 275th Army Band was assigned to New York-Philadelphia Sector with permanent station at Fort Hamilton, N.Y. and attached to the 113th Infantry with temporary station at Bethpage, Long Island, N.Y.

The Headquarters, and Battalion, 113th Infantry, South Jersey Local Sector moved from Woodbine, N.J. to Tuckahoe, N.J., arriving 20 September 1943.

Headquarters and Headquarters Company, 2nd Battalion, 113th Infantry completed move from Armory at Georgetown, Del., to CCC Camp in the vicinity of Georgetown 30 November 1943.

199TH FIELD ARTILLERY BATTALION  
Fort Hamilton, New York

The 199th Field Artillery Battalion was organized 20 February 1942 by letter AGO 320.2 MR-M-C, dated 17 February 1942 by redesignation of the 1st Battalion 165th FA (75mm Truck-drawn) which was organized in 1940 per General Orders No. 2, AGO, New Jersey, dated 29 January 1940 from the 1st Battalion, 112th FA of New Jersey National Guard. The Battalion is composed of units as indicated:

<u>199th FA</u>	<u>Organized</u>	<u>Originally Organized</u>
Hq. Battery	June 27, 1921	Hq. 1st Battalion 112th FA
Battery "A"	April 27, 1895	Gatling Gun Co "A"
Battery "B"	June 15, 1936	Battery "D", 112th FA
Battery "C"	May 8, 1916	Battery "C", 112th FA

The 199th Field Artillery Battalion was attached to the 44th Division from September 1940 to December 1941, during which time basic, unit and combined training was conducted. Unit was on maneuvers in Carolina area from October to December 1941.

The only combined training held since December 1941 was a one month training period at Fort Dix, New Jersey in June 1943, during which time the entire Headquarters and Service Batteries were present and platoons from firing batteries were present for two (2) weeks each.

The weapons of the battalion were changed on 27 May 1942 from 75mm (truck-drawn) to 105mm Howitzer (truck-drawn) per General Orders No. 5, Headquarters, New York-Philadelphia Sector, dated 27 May 1942.

The Antitank and Antiaircraft Platoon was activated as part of Headquarters Battery on 1 June 1942 per General Orders No. 8, Headquarters, New York-Philadelphia Sector, dated 27 May 1942.

The 199th Field Artillery Battalion was relieved from assignment to New York-Philadelphia Sector and Eastern Defense Command and ordered to move to Fort Dix, New Jersey by Movement Orders dated 23 November 1943 by authority of War Department letter, file AG 370.5 (17 November 1943) OB-S-GNGOT-M, Subject: "Transfer of Field Artillery Battalions", dated 19 November 1943. Ordered to arrive Fort Dix, New Jersey on or about 27 November 1943 at which time assigned to the Army Ground Forces and XIII Corps.

671st COLLECTING COMPANY (Sep)

The 671st Company, (Sep), was activated 25 May 1942 at Fort Hancock New Jersey by authority War Department, AGO, letter, file AG 320.2 (5-6-42)MR-M-GW, dated 7 May 1942, to Eastern Defense Command and First Army, and by Paragraph 1, General Orders No. 6, Headquarters New York-Philadelphia Sector, Fort Hamilton, N.Y., dated 20 May 1942.

Concurrently with activation all personnel and equipment of former Companies A and E, 119th Medical Regiment, (Company A redesignated and Company E disbanded by War Department, AGO, letter, file AG 320.2 (12-17-41) MR-M-C, dated 20 February 1942, subject: "Reorganization of the 44th Division) now attached to the 113th Infantry Combat Team, are transferred to the 671st Collecting Company (Sep).

22nd QUARTERMASTER REGIMENT (T)  
(Headquarters Detachment)  
(Companies F and G)  
(Medical Section, 2nd Bn)

Headquarters Detachment, Companies F and G, 22nd Quartermaster Regiment (T) were activated at Fort Dix, New Jersey on 1 June 1941 by Paragraph 1 (a) General Orders No. 15, Headquarters Second Corps Area, dated 22 May 1941 by authority War Department, TAG, letter, file Ag 320.2 (4-25-41) (RET) M-C, subject: "Constitution and activation of Units," dated 25 April 1942. Companies E and H of 22nd Quartermaster Regiment (T), 2nd Battalion, are not attached to the 113th Infantry Combat Team.

The Medical Section, 2nd Battalion, 22nd Quartermaster Regiment (T) was formed on 5 January 1943 by authority letter Eastern Defense Command and First Army, file ON 200.9/212 dated 24 October 1942, subject: "Medical Enlisted Personnel."



SECTION III

SUBSECTORS AND HARBOR DEFENSES  
IN OPERATION

---

NOTE: The nature of the organization for the defense of the coast makes it evident that in following the course of New York-Philadelphia Sector development (Section II we are bound to include steps that are applicable to subsectors and harbor defenses. For that reason a great deal has gone before will be taken for granted in considering the development of subsectors and harbor defenses to avoid repetition in detail. Subsector and harbor defense are considered together since they are, in Sector, tactical "Siamese Twins," the command consolidated and the planning concurrent.



SECTION III

(Part 1)

---

NEW YORK SUBSECTOR  
AND  
HARBOR DEFENCES OF NEW YORK

---

(Harbor Defenses of Sandy Hook,  
Southern New York and Eastern  
New York)

(HECH'S, FORCES AND ARMAMENT)

SECRET

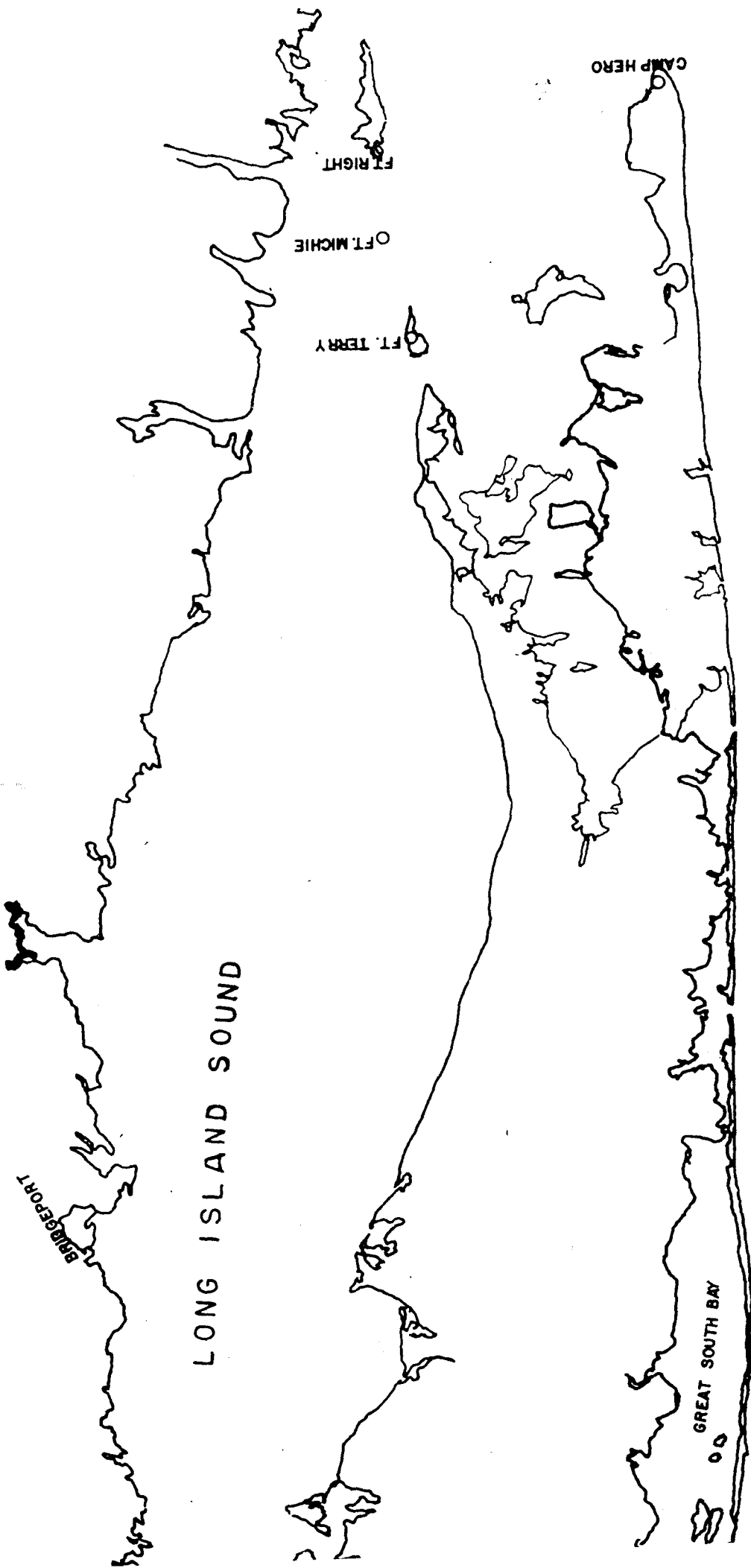

The War and the beginnings of New York-Philadelphia Sector found New York's several harbor defenses set up with a somewhat archaic organization, that of three harbor defenses for one harbor entrance (if we consider the Harbor Defenses of Long Island Sound and not the Harbor Defenses of Eastern New York as the "back door" entrance). However this apparent disunity of command before March 5, 1942, when the Harbor Defenses of New York Command was constituted, did not really exist since the Harbor Defenses of Sandy Hook stood as a superior command of all the harbor defenses. (See Plate No. 7 following page ).

With the Seventh of December, 1941 and the subsequent emergency swing over to Sector operation according to the "ST" plan of 1941, it was the Harbor Defenses of Sandy Hook that increased its scope of command to embrace the functions of the New York Subsector that was not officially activated by War Department Order until 1 March 1942. Brigadier General P.S. Gage, Commanding General of the Harbor defenses of Sandy Hook, became, and was until the end of February 1944 Commanding General, Harbor Defenses of New York and New York Subsector.

One of the first moves to expand the command to meet the increase in scope of the War mission of New York Subsector as compared to that of the Harbor Defenses and Coast Artillery District before the Declaration of War was the reinforcement supplied by two battalions of the 113th Infantry Combat Team as outlined under "Sector in Operation," Section II, Part 1. This move was initiated by telephonic instructions between Headquarters, First Army, and those of the II Army Corps, Willard Hall School, Eighth and Adams streets, Wilmington, Delaware, 16 December 1941.

These instructions were confirmed by Movement Order No. 505, First Army, of the same date, which sent the 113th Infantry, less detachments, with one

battery of Light Field Artillery and one Company of Combat Engineers attached to "concealed bivouacs" in the vicinity of Freehold, N.J. for "temporary duty."

These were the troops that were to help fulfill the mission assigned to New York Subsector and constituted the 1st and 2nd Battalions, 113th Infantry, with attached units, since the 2nd Battalion, with attached units, intended, was ordered to the vicinity of Georgetown for Philadelphia Subsector.

The report of the movements of the two battalions of the 113th Infantry Combat Team assigned to New York Subsector were described in a report made 17 February 1942 by Colonel H. Norman Schwarzkopf, then Commanding Officer, the 113th Infantry, to the Executive Officer, New York-Philadelphia Sector. This report, in part, read:

"The 1st Battalion left Fort Dix, N.J., December 11, 1941 and arrived Mitchel Field, Long Island, December 12, 1941. Company C left Mitchel Field, Long Island, N.Y., December 14, 1941 and arrived Camp Upton, Yaphank, L.I., N.Y. on December 14, 1941.

"The 2nd Battalion left Fort Dix, N.J., December 15, 1941 and arrived Collingswood Park, N.J., December 15, 1941. Left Collingswood Park, N.J., December 20, 1941 and arrived at Eatontown, N.J., December 20, 1941.

"Headquarters Section of the 113th Infantry left Fort Dix, N.J., and arrived in Freehold, N.J., December 15, 1941. Left Freehold, N.J., and arrived in Fort Hancock, N.J., December 23, 1941."

With the units moving into stations the planning for defense was beginning to materialize and, during the opening months of operation under Sector we find the personnel for New York Subsector, including the Harbor Defenses within it, according to a Sector Station List dated 3 February 1942, recorded as follows: (Ref. 319.26/68)

HARBOR DEFENSES OF EASTERN NEW YORK - Fort Totten, N.Y.  
Det. Battery D; 7th CA (HD)

HARBOR DEFENSES OF SOUTHERN NEW YORK - Fort Hamilton, N.Y.  
Hq. and Hq. Btry; Btry D; 5th CA (HD)  
Fort Wadsworth, N.Y.  
Btrys. A, B, 5th CA (HD)  
New York Harbor Entrance Control Post

HARBOR DEFENSES OF SANDY HOOK

- Fort Hancock, N.J.  
Hq. & Hq. Btry, HD of Sandy Hook  
7th CA (HD) (less 2nd Bn.)  
52nd CA (Ry) (less 1st Bn & Btrys. D, E, F.)  
245th CA (HD) (less 3rd Bn.)  
95th Ordnance Co. (Maint Ry Arty)  
Hq & Hq Co., 113th Inf. (less Det)  
Service Company, 113th Inf. (less det)  
Anti-Tank Co., 113th Inf. (less 3 platoons)  
1st Bn. 165th FA (less Btrys A, B and C)  
Hq. 2nd Bn. 104th Eng.  
Det. Co A 119th Med. Regt. (Col)  
Det. Co F 119th Med. Regt. (Amb)  
Reg'tl Med. Sect. & Band, 113th Inf.  
A.M.P. General Ed. O.C. Ord Based at USA  
Cable Ship Joseph Henry base Brooklyn

Fort Tilden, N.Y.

2nd Bn. 7th CA (HD) (less Det)  
3rd Bn. 245th CA (HD)

ATTACHED COMBAT TEAMS

- Mitchel Field, Long Island, N.Y. (Camp Mills)  
Plat. Anti-Tank Co. 113th Inf.  
1st Bn., 113th Inf. (less Co. C)  
Btry A, 165th FA (less Det.)  
Co. E 104th Eng.  
Det. Co. A 119th Med. Regt. (Col.)  
E 119th Med. Regt. (Amb)  
B 119th QM Regt. (Trk.)

Yaphank, Long Island, N.Y. (Camp Upton)

Co. C, 113th Inf.  
Det. Btry A, 165th FA

Ratontown, N.J.

Plat. Anti-Tank Co. 113th Inf.  
3rd Bn., 113th Inf.  
Btry. B 165th FA  
Co. D, 104th Eng.  
Det. Co. A, 119th Med. Regt. (Col.)  
Det. Co. F 119th Med. Regt. (Amb.)  
Det. Co. B 119th QM Regt. (Trk.)

A chart of contemporary date, January 13, 1942, shows the organization of the York Subsector under the separate harbor defenses. (See Plate No. 13)

ORG. CHART - NYSS. JAN 13, 1942.

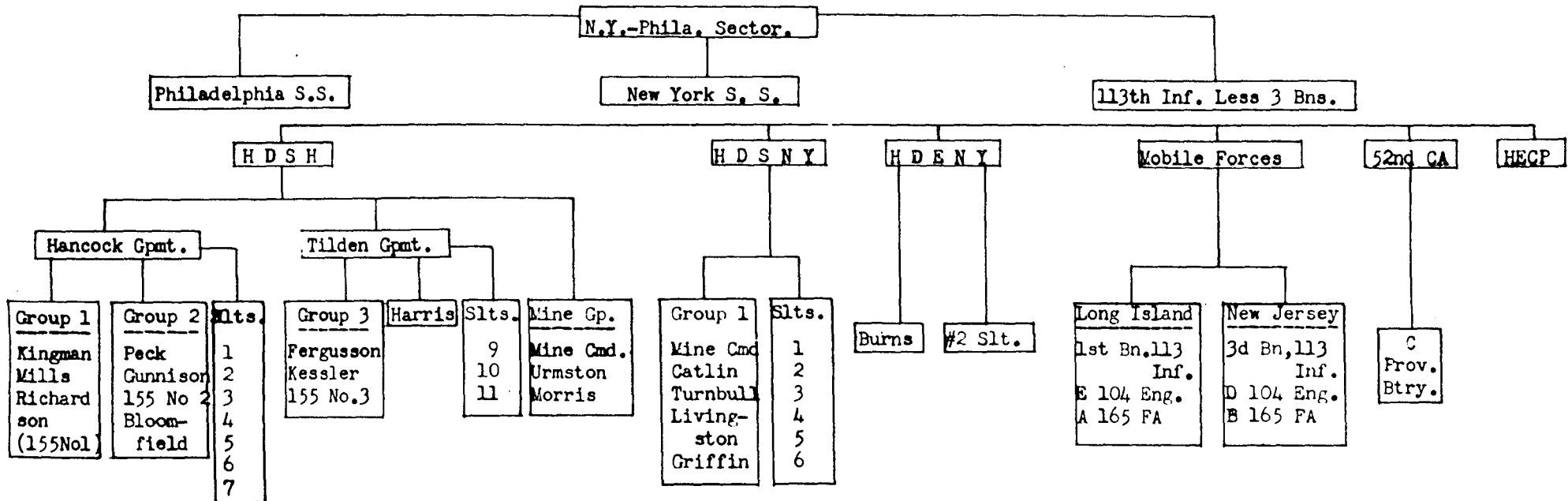

PLATE # 13



In this set-up of harbor defenses in New York Subsector Fort Tilden was a subpost of Fort Hancock and Fort Hamilton was an exempted station under control of the Commanding General, New York Port of Embarkation.

Also stationed at Forts within Subsector were:

At Fort Totten - Hq. and Hq. Btry., 1st Army AA Artillery Command; 38th Coast Artillery Brigade and the 62nd Coast Artillery and Band.

At Fort Hancock - Station Compliment CASC Unit 1225 and 151st Station Hospital.

At Fort Wadsworth - Station Compliment CASC Unit 1205 and cadre for CASC Unit 1216; 716th MP Bn.; 175th Signal Repair Co.; 61st Coast Artillery and 213th Coast Artillery. Miller Field a sub-post of Fort Wadsworth with CASC Unit 1216 not activated.

These units were designated as above in the Second Coast Artillery District station list dated 15 January 1942.

In this same period a report of the assignment of armament in the New York Subsector, dated 30 December 1941, shows the following units, and their state of training, manning guns and installations as follows:

ORGANIZATION	ARMAMENT	TYPE	STATE OF TRAINING
"A" 7th CA	Mines		Excellent
"B" 7th CA	Mines		Excellent
"C" 7th CA	Morris	3" BC	Excellent
	Urmston	5" BC	
"D" 7th CA	Fergusson	6" BC	Satisfactory
"E" 7th CA	Burns	3" BC	Satisfactory
"F" 7th CA	AA No. 3	3" AA	Satisfactory
"G" 7th CA	Search-Lights		Satisfactory
"C" 52nd CA	8" Ry	8"Ry	Satisfactory
"A" 5th CA	Mines		Excellent
"B" 5th CA	Turnbull	3" BC	Satisfactory
	Catlin	3" BC	
"D" 5th CA	Griffin	3" BC	Satisfactory
	Livingston	6" BC	
"A" 245th CA	AA No. 1	3" AA	Satisfactory
"B" 245th CA	AA No. 2	3"AA	Satisfactory
"C" 245th CA	Search-lights	AA	Satisfactory
"D" 245th CA	Richardson	12" DC	Satisfactory

"E" 245th CA	Mills	12" BC	Satisfactory
"F" 245th CA	Mills	12" BC	Satisfactory
"G" 245th CA	Harris	16" BC	Satisfactory
"H" 245th CA	Harris	16" BC	Satisfactory
"I" 245th CA	Kessler	6 " BC	Satisfactory
"K" 245th CA	Peck	6" BJ	Satisfactory
"L" 245th CA	Gunnison	6" DC	Satisfactory
"M" 245th CA	Bloomfield	12" DC	Satisfactory
Slt. 245th CA	Search- lights.	Sea- coast	Satisfactory

Changes were many in these early days of the war effort and in subsequent lists, scarcely a month apart, alterations were made. The 25th Sep. CA Bn. (Sep) appeared under the Harbor Defenses of Sandy Hook; the 2nd Bn., 165th FA became the 199th FA Bn., the 119th QM Regt., Co. B changed to the 143rd QM Co. (Trk.); the 177th Engineers changed to the 175th Engineers; the 119th Medical Regt., Cos. A and E changed to the 671st Collecting Co.

Meanwhile the reorganization of the harbor defenses within New York Subsector was under way.

On May 5, 1942 the separate harbor defenses for the New York Area were inactivated and the Harbor Defense of New York were created. The move was ordered in General Orders No. 5, May 4, 1942, by command of Brigadier General Haines.

Under this order the Headquarters and Headquarters Battery, Harbor Defenses of New York "is constituted and activated at Fort Hancock, New Jersey, effective May 5, 1942" and Brigadier General Philip S. Gage, U.S. Army assumed command of the Harbor Defense of New York.

This order inactivated the Headquarters and Headquarters Battery, Harbor Defenses of Sandy Hook and the personnel and equipment transferred to the new headquarters. The new headquarters comprised all units and installations assigned to and included in the Harbor Defenses of Sandy Hook, Southern New York and Eastern New York and the designations of these units were abolished.

This move to consolidate the command of armament in the New York Harbor area was the result of contention of New York-Philadelphia Sector based on the definition of a harbor defense in paragraph 1a AM 90-40, October 2, 1937 which designated a harbor defense "an administration and tactical command provided for the defense of a harbor or other water Area." (ref. Secret Letter Hq. NYPS Mod. File 000, April 7, 1942.)

In describing the harbor defenses of New York the Sector pointed out that there were three "harbor defenses" for one harbor as follows:

The Harbor Defense of Sandy Hook, consisting of Ports Hancock and Tilden, the armament of which is sited to cover the seaward approaches to New York Harbor.

The Harbor Defense of Southern New York, consisting of Ports Hamilton and Wadsworth, the armament of which is sited to support in depth the armament in the Harbor Defense of Sandy Hook.

The Harbor Defenses of Eastern New York, consisting of rapid fire and fixed aa batteries at Fort Totten sited to support in depth the primary armament located in the Harbor Defenses of Long Island Sound, covering the eastern approach to New York Harbor.

Sector contented that upon the completion of the modernization program that the interlocking of the three harbor defenses will be achieved to a much greater degree with overlapping fields of fire of seacoast batteries, fire control facilities used in common and joint action with the inshore patrol. Sector also based its contention on paragraph 1c Fm 4-8, Coast Artillery Field Manual, July 29, 1940 that: "If a number of organizations are engaged in performing the same duty, teamwork will be secured by placing them under a single commander."

These beliefs had led Sector to place the Harbor Defenses of Southern New York and the Harbor Defenses of Eastern New York under the tactical control of the Commanding General, Harbor Defenses of Sandy Hook charging that authority with the security of New York Harbor. This action was taken with the outbreak

of hostilities and had been in effect about four months.

Now to ease the administration burden and to create a sound tactical organization Sector sought to consolidate the command into a single entity.

The recommendation was approved by the War Department indorsement of April 27, 1942.

The Station List for the New York Subsector under the reorganization of the Harbor Defenses, dated May 6, 1942, looked like this with some of the redesignations noted above still not accomplished:

#### NEW YORK SUBSECTOR

##### Harbor Defenses of New York

Hq. and Hq. Btry., HD of NY  
5th CA (HD) (less Btrys A and B)  
    Btrys. A and B, 5th CA (HD)  
7th CA (HD) (less 2nd Bn.)  
    2nd Bn. 7th CA (less Btry E)  
    Btry E, 7th CA  
52nd CA (Ry) (less Btrys C and E)  
245th CA (HD) (less 3rd Bn.)  
    3rd Bn, 245th CA (HD)  
USAMP Gen. Hd. O.C.Ord  
New York Harbor Entrance Control Post

Ft. Hancock, N.J.  
Ft. Hamilton, N.Y.  
Ft. Wadsworth, N.Y.  
Ft. Hancock, N.J.  
Ft. Tilden, N.Y.  
Ft. Totten, N.Y.  
Ft. Hancock, N.J.  
Ft. Hancock, N.J.  
Ft. Tilden, N.Y.  
Army Base, Brooklyn, N.Y.  
Ft. Wadsworth, N.Y.

##### 1st and 3rd Bns, 113th Inf. Combat Team

1st Bn, 113th Inf (less Cos. B,C, and 1 Plat, Co. D)  
    Co B and 1 Plat Co. D, 113th Inf.  
    Co. C, 113th Inf.  
1st Plat., Antitank Co., 113th Inf.  
Btry A, 199th FA BN (less Det.)  
    Det. Btry A, 199th FA BN  
Co. B, 177th Engineers (GS)  
Det. 119th Med.  
Det. 143rd QM Co. (Trk)  
Det. 143rd QM Co. (Trk)  
3rd Bn, 113th Inf.  
3rd Plat., Antitank Co., 113th Inf.  
Btry B, 199th FA BN  
Co. A, 177th Engineers (GS)  
Det 118th Med.  
Det 143rd QM Co. (Trk)

Mitchel Field, N.Y.  
Riverhead, L.I.N.Y.  
Yaphank, L.I.N.Y.  
Mitchel Field, N.Y.  
Mitchel Field, N.Y.  
Yaphank, L.I.N.Y.  
Mitchel Field, N.Y.  
Mitchel Field, N.Y.  
Mitchel Field, N.Y.  
Yaphank, L.I.N.Y.  
Eatontown, N.J.  
Eatontown, N.J.  
Eatontown, N.J.  
Eatontown, N.J.  
Eatontown, N.J.  
Eatontown, N.J.

The organization of New York Subsector, skeltonized, according to information gleaned from a contemporary Joint Defense Plan of the Subsector, now appeared like this:

Generally speaking this basic organizational set-up for New York Subsector held for the greater part of a year with secondary adjustments as armament was shifted to solve certain problems of harbor and coastal defense and the modernization program that Sector was embarked upon progressed.

While changes in plans of organization were being made the physical improvements of modernization were also being promoted as rapidly as possible. These guns were being modernized by shield or casemate or even being moved bodily from one site to another also had to serve a tactical purpose in the Harbor Defenses of New York. This worked a necessary hardship on manning personnel and engineers. However it had to be done

The directive to govern the work of modernization was laid down by the War Department in a letter of 13 March 1942 in which it was ordered that engineers and Ordnance to plan their work that one gun of each two-gun battery being modernized be maintained in a state of readiness that will permit service firing at all times. The letter further stipulated that the second gun of each battery will also be capable of service firing within 36 hours notice by using improvised ammunition service but with full electrical power and fire control facilities.

About this time an oddity in defense "armament" was studied with a view to possible use in the New York-Philadelphia Sector. It was the emplaced flame thrower and the only possible location for them was found in New York Subsector. This "new" weapon was never emplaced. However a short note on its abortive history may be of interest. (ref. 470/60).

The flame thrower, as proposed, consisted of an apparatus that could be buried in the ground so that the machine was hidden from casual observation. It was proposed that the flame throwers be installed along coastlines to prevent establishment of bridgeheads by enemy forces. It suggested that they may also be used as road blocks by installation in narrow defiles, on airports to prevent landing of enemy planes.

It was possible to operate the mechanism by remote control, actuating the flow of gas and oil to shoot a stream of flame forty feet from two nozzles located in a turret dome that raised out of the ground to operate.

Only one location was recommended by sector (March 26, 1942) for the use of this weapon. The location was in the Harbor Defenses of Sandy Hook to be used on the causway entering Ft. Hancock, N.J. Other sites were forbidden by the following reasons given by sector to EDC.

"Due to the high winds and shifting sand on the beaches in the New York-Philadelphia Sector no other locations are recommended along the coast line.

"Installation of the flame throwers at points inland is not recommended due to inability to maintain and guard the immense number required to adequately cover the great number of vital points in the Sector. A portable flame thrower is more suitable for this purpose."

Shifts in the assignment of personnel to adjust manning to accommodate construction due to modernization and because of other factors was continually going on during these early days of planning.

In one instance the combat team forces under New York Subsector were augmented by the 3rd Battalion, 101st Infantry. It was in July 1942, in a letter, Sector to Subsector, dated 18 June, 1942, (Ref. 320.2/619) the Commanding General, Subsector, was advised that the 3rd Bn, 101st Infantry, reinforced, would be moved from Camp Mills, N.Y. to Bethpage, Long Island, N.Y. and that the battalion of "following assigned and attached units" would be attached to New York Subsector as of date of arrival at station:

3rd Battalion 101st Infantry  
Battery "B", 101st Field Artillery Battalion  
Platoon, Anti-tank Company, 101st Infantry  
Det. Headquarters Company, 101st Infantry  
Det. Service Company, 101st Infantry  
Det. Medical Detachment, 101st Infantry  
Det. 114th Medical Battalion

These units arrived at their new station at Bethpage, 26 July 1942.

(ref. 319.1/3)

This increase in Combat Team forces for Long Island, N.Y. was the outcome of the Amagansett, Long Island, N.Y., landing by enemy agents who, "opposed" only by a lone Coast Guardsman, were able to land, board a train for New York City and subsequently the interior of the United States while the German U-Boat that brought them was able to escape. This circumstance has already been described

in Section II, Part 2 of this chronicle.

The Amagansett affair occurred on 13 June 1942 and one of the aftermaths was the decision that concentration of patrols on the shores of Long Island was too light and that, since any shortcoming of Coast Guard or any other assisting forces guarding beaches did not relieve the Army of beach surveillance or defense, the Army patrols should be increased in strength and scope. It was to meet this need, as it was felt then, that the 3rd Battalion, 101st Infantry was brought on the scene, transferred from New England Sector to New York-Philadelphia Sector and New York Subsector.

The stay of these 101st Infantry troops however was a short one. On 11 September 1942 Sector directed that the 3rd Battalion, 101st Infantry be relieved from "its present assignment and mission on or about 1 October 1942.

(Ref. 370.5/114)

Further it was stated "no change in subsector Mission is foreseen". Mobile forces available had to be used in accomplishing this and the result was placed at Bethpage; one rifle company at Lake Ronkonkoma, one rifle company reinforced with one platoon of the heavy weapons company at Watermill, all from the 1st Battalion Combat Team, 113th Infantry, and the remainder of the battalion Combat Team at Riverhead, Long Island.

The 3rd Battalion, 101st Infantry was moved to Fort Meade, MD. (Ref. 370.5/121)

One of the major shifts in personnel during this period was the reshuffling of two battalions, the 2nd of the 7th CA and the 3rd of the 245th CA. The problem was this: (Ref. 370.5/101)

The two battalions were stationed at Ft. Tilden and operated under their respective regimental commanders and under Colonel Thomas E. Jeffords, CAC, who



was listed as the Executive, Harbor Defenses of New York.

This situation, as it was pointed out at the time, required that administration matters originating with the troops at Ft. Tilden follow a cumbersome course through the post Commanding Officer to two different regiments at Ft. Hancock. The solution was found in the fact that the 7th Coast Artillery is a two battalion regiment or just the size of unit required for Ft. Tilden and that the entire 7th CA could be stationed at Ft. Tilden and all the 245th at Ft. Hancock. This was effected 23 September 1942 by Special Orders No. 29, Hq. New York Subsector, dated 20 September 1942 by authority: str. 13 320.2 (9-21-42), MR-M-3N, TAGO, Aug. 27, 1942, subject: "Transfer of Certain Coast Artillery Units." The transfer was effected, quoting the authority, as follows:

"The 3rd Battalion, 245th Coast Artillery (HD), consisting of Battalion Headquarters and Headquarters Battery, and Batteries G, H and I, will be transferred ..... without personnel and equipment from Fort Tilden, New York, to Fort Hancock, New Jersey.

"The 1st Battalion, 7th Coast Artillery (HD), consisting of Battalion Headquarters and Headquarters Battery, and Batteries A, B and C, will be transferred ..... without personnel and equipment from Fort Hancock, New Jersey, to Fort Tilden, New York.

"Concurrently therewith, the personnel and equipment of the 3rd Battalion, 245th Coast Artillery (HD) will be transferred to the 1st Battalion, 7th Coast Artillery (HD) without change of station; and the personnel and equipment of the 1st Battalion, 7th Coast Artillery (HD) will be transferred to the 3rd Battalion, 245th Coast Artillery (HD) without change of station.

"These are permanent changes of station."

Not the least of the immediate problems of the Harbor Defenses of New York in the question of priority of manning batteries with the personnel available was the Anti-Motor Torpedo Boat or AMTB defense which has been referred to in Organization of Sector (Section II, Part I). With production of new weapons, notably the 90mm AMTB, not available to Defense Commands, the 3-inch rapid fire gun

was the stop-gap armament.

The solution of this problem had been a subject of tactical planners since March 1942 and the resulting decision called for the resiting of many of these 3-inch batteries in the New York Harbor. Originally these guns were designed to meet the attack of small boat raids, especially those that might be engaged in mine-sweeping missions. The MTB brought new factors into the problem of siting.

The result was that by the close of 1942 Battery Catlin's six guns at Fort Wadsworth had been relocated to meet new tactical demands. Four of them, in the future to be known as New Catlin, going to Norton's Point (Sea Gate) N.Y. and the remaining two going to form a new battery at Rockaway Point, N.Y.; a battery designated by the tactical number 20. This pulled the guns from coverage of the Narrows to the outer harbor defense.

At the same time four guns of Battery Turnbull, Fort Wadsworth, had been relocated to improve the effectiveness of the field of fire. The new location was also at Fort Wadsworth. The two remaining guns of this six-gun battery were shipped to Fort Miles to help make up the four-gun, 3" EE, battery being located there.

Another relocation consumed at the same time was that of the two guns of Battery Urmston at Fort Hancock. This battery was also shifted within the confines of the Fort and remained at Fort Hancock.

With the whipping into shape of the plans for defense and a considered evaluation of the armament on hand and its most efficient use Sector directed the Harbor Defenses of New York to lower the classification on many batteries and to transfer other armament transferred to Ordnance for salvage.

Not the least factor in this decision was the pinch of personnel, a lack

that could not at that time be corrected since the War Department in an indorsement of October 19, 1942 stated:

"Due to the shortage of enlisted personnel, no activation of units to be employed within Continental United States can be favorably considered at this time."

As a result of these conditions Sector directed that the following armament be placed in Class "C", caretaking status, on 3 November 1942:

Battery Johnston, Fort Hamilton  
Battery Mills, Fort Wadsworth  
Battery Gunnison, Fort Hancock

The following batteries were placed in Class "B", for which the active season was directed to extend from April 1 to September 30:

Battery Doubleday, Fort Hamilton  
Battery Brown, Fort Hamilton  
Battery Dix, Fort Wadsworth  
Battery Bloomfield, Fort Hancock  
Battery Richardson, Fort Hancock

Further, nine days later, on 12 November 1942, the following armament in the Harbor Defenses of New York were ordered transferred to the Ordnance Officer, Second Service Command for salvage, the gun tubes to be turned over to the Chief of Ordnance "against probable future use" and the carriages disposed of as scrap. (Ref. 660.21/47)

Batteries Upton, Gilmore, all 10", DC, and batteries Richmond, Ayers, Hudson, Alexander, all 12", DC, batteries.

In a report of December 29, 1942, the following status of obsolete armament in the New York Subsector was given. (Ref. 660.2/67)

Battery Upton Both guns and carriages removed.

Battery Richmond Both guns removed and in position for storage. Both carriages have been removed.

Battery Ayres Both guns removed and in position for storage. Cutting and removal of carriages in progress.

Battery Hudson No. 2 gun removed from carriage and in position for storage. No. 1 gun is being removed from its carriage.

Battery Gilmore, Battery Halleck, Battery Alexander. Salvage of these batteries has not been started.

Since we have been talking of personnel problems of Harbor Defense and Subsector it should be interesting at this time to not just what the strength of the defense forces were, the initial forces for manning Harbor Defense and the first line of beach defenses, not the supporting forces.

By the turn of the year 1942-43 the forces in New York Subsector and the Harbor Defenses of New York had reached a strength of 397 officers, 43 warrant officers and 9875 enlisted men, a figure that did not depart from the average for the operation of Harbor Defenses and Subsector during its full operation.

Of these figures the Harbor Defense represented 242 officers, 37 warrant officers and 5732 men (enlisted) as their share of the total. The Combat Team represented 155 officers, 6 warrant officers and 4143 enlisted men as their share. This report was made by the Subsector S-1 December 1943. (Ref. 319.5/53)

This strength was distributed, according to the Sector Station list dated 1 December 1942, as follows:

NEW YORK SUBSECTOR

Harbor Defenses of New York

Hq and Hq Btry, HD of NY (less HCOF)  
HECP

Fort Hancock, N.J.  
Fort Wadsworth, N.Y.

5th CA (HD) (less Band, Bn Hq Btrys, Btrys C, E & F  
and 3rd Bn, Inactive; Btry D, Med Det and  
Det Hq Btry

Fort Wadsworth, N.Y.  
Fort Hamilton, N.Y.

Btry D, Det Hq Btry and Med Det

7th CA (HD) (less Band and Btry E)  
 Btry E, 7th CA  
 52nd CA (Ry) (less 1st and 2nd Bns and Btry E)  
 245th CA (HD) (less Btry L)  
 Btry L, 245th CA  
 5th CA Mine Planter (USAMP Ord)  
 19th CA Mine Planter Btry

Fort Tilden, N.Y.  
 Fort Totten, N.Y.  
 Fort Hancock, N.J.  
 Fort Hancock, N.J.  
 Nortons Pt., Bklyn, N.Y.  
 Fort Hancock, N.J.  
 Fort Hancock, N.J.

113th Infantry Combat Team (less 2nd Bn)

Hq & Hq Company (less Det) and Band, 113th Inf.	Fort Hancock, N.J.
Service Co, 113th Inf (less Dets)	
Antitank Co, 113th Inf	Freehold, N.J.
199th FA Bn (less 3 Btrys & 1 Plat AA & AT)	Fort Hancock, N.J.
1 Plat AA & AT, 199th FA	Eatontown, N.J.
113th Inf Recruit Training center	Fort Hancock, N.J.
2nd Bn (less Cos. D & F and 1 Plat Co E) and Det	
Hq & Service Co, 132 Engrs (C)	Fort Hancock, N.J.
1 Plat Co E, 132nd Engrs (C)	Bethpage, N.Y.
1 Plat Co D, 132nd Engrs (C)	Riverhead, N.Y.
Med Det, 113th Inf. (less Dets)	Fort Hancock, N.J.
671st Collecting Co (Sep) (less Dets)	Fort Hancock, N.J.
1st Bn, 113th Inf (less Cos A, B & C)	Riverhead, N.Y.
Co A, 113th Inf	Bethpage, N.Y.
Co B, 113th Inf	Lake Ronkonkoma, N.Y.
Co C, 113th Inf	Watermill, N.Y.
Btry A, 199th FA Bn	Riverhead, N.Y.
Det Service Co, 113th Inf	Riverhead, N.Y.
Det Med Det, 113th Inf	Riverhead, N.Y.
Det 671st Col Co (Sep)	Bethpage, N.Y.
3rd Bn, 113th Inf (less Cos I & L)	Eatontown, N.J.
Co L and Det Co M, 113th Inf	Penn State Forrest, N.J.
Co I and Det Co M, 113th Inf	Island Heights, N.J.
Btry B, 199th FA BN	Eatontown, N.J.
2nd Bn, 22nd QM REGT (Trk)(less Cos H, G and Det Co F)	Eatontown, N.J.
Det Med Det, 113th Inf	Eatontown, N.J.
Det Service Co, 113th Inf.	Eatontown, N.J.
Det Med Det, 113th Inf	Penn State Forrest, N.J.
Det Co F, 22nd QM Regt (trk)	Penn State Forrest, N.J.
Det 671st Col Co (Sep)	Penn State Forrest, N.J.
137th Sig Red Int Co	Mitchell Field, N.Y.

Two new USA Mine Planters were scheduled to arrive in the Harbor Defenses of New York in the first half of 1943 according to information from the War Department, (AGO), dated 19 December, 1942, the "Story" on 1 January and the "Mayback" at a date not reported. (Ref. 320.2/756 NYPS Binder No. 6)

Previous to this, 18 November 1942, the War Department (AGO) had directed the activation of the 19th Coast Artillery Mine Planter Battery at Fort Hancock which was accomplished 28 November by General Orders No.6, Hq. 245th CA. This CAMP Battery, however, did not stay in the Harbor Defenses of New York but left (42 enlisted men) Fort Hancock, N.J. on 16 December 1942 to join the USAMP Frank at Point Pleasant, West Virginia. The Frank later (1 April 1943) was assigned to the Harbor Defenses of the Delaware. (Ref. 319.1/38 & 319.1/94)

The USAMP Story arrived ahead of schedule and in the S-1 report of 23 December 1942 it is reported that the Story arrived at Fort Hancock, N.J. from New Orleans, La., on 22 December, manned by the 15th CAMP Battery. (Ref. 319.1/43)

The USAMP Mayback did not arrive in the Harbor Defenses of New York until May 13, 1943. It is manned by the 20th CAMP Battery. (Ref. 319.1/107)

In this connection it may be noted that the Cableship Joseph Henry, which had been in the command since the beginnings of Sector, was relieved from its attachment to New York-Philadelphia Sector and the Harbor Defenses of New York by order of Eastern Defense Command and First Army in a letter dated 7 September 1942. It was attached, "effective at once," to the New England Sector. (Ref. 320/59)

Here it may also be noted that the mine project for the Harbor Defenses of New York were 100 per cent planted by December 1943 and 100 per cent effective according to the G-3 report of that period.

Several shifts in personnel and assignments were made early in the year of 1943 with troops coming in New York Subsector and the Harbor Defense.

Early in 1943 the New York Subsector received the 265th Coast Artillery for an "indefinite" stay when it was ordered from Fort Jackson, South Carolina to

Fort Hancock, N.J. as indicated in a Sector Operational Directive of 29 January, 1943. (Ref. 320/103)

During its assignment the 265th CA "will be subject to the training and operational directives applicable to other Harbor Defense Organizations". The outfit arrived 16 February 1943, with 63 officers and warrant officers, and 1305 enlisted men.

On 18 February 1943 a letter from Headquarters, XIII Corps, Providence, Rhode Island, advised that this unit is to prepare at once for overseas service and that "immediate steps will be taken to enable the unit to complete by 1 May 1943" training for such service.

The 265th CA, a Type "B" Regiment was assigned to Batteries according to NYPWR plan dated 1 July 1943 as follows:

Btry "A" - Battery Peck, Fort Hancock  
Btry "B" - Battery Morris, Fort Hancock  
Btry "C" - New Catlin, Norton's Point  
Btry "D" - Construction 219, Havesink (6-inch BC battery)  
Btry "E" - Battery Kessler, Fort Tilden  
Btry "F" - Battery Turnbull, Fort Wadsworth

The unit was eventually moved out of Subsector and Sector in a shipment for the Seattle Port of Embarkation 11 January, 1944 to arrive and pass from the jurisdiction of Sector 16 January 1944.

Although the Antiaircraft Command, Eastern Theater of Operations and later Eastern Defense Command, was created 13 January 1942, divorcing it from Harbor Defense and Subsector, (See "Sector in Operation," Section II, Part 1), some loose ends were left over and not adjusted early part of 1943.

The sh  
March 1, 1943, Sector  
forces was outlined in a letter of  
quest of the Commanding General,

AAA Command in which "informal" arrangements were desired being made to relieve the 701st CA (AA) of the 3-inch AA (fixed) assignments at Forts Wadsworth, Hamilton and Totten, replacing these forces with personnel from the Harbor Defenses of New York by March 15, 1943.

Further it was stated that Harbor Defense Personnel was to be made available by placing Batteries Livingston, Griffin and Burns in a class "B" status.

(Ref. 220.31/60)

In amplification of this letter an operational directive addressed to the Commanding General, New York Subsector, from Sector, was issued 11 March, 1943 in which it was stated: (Ref. 220.31/65)

"Harbor Defense units in the New York-Philadelphia Sector manning fixed Anti-aircraft armament are under the C.G. AAAC, EDC, for tactical control and training.

"The mission of fixed AA Batteries against water borne targets is coordinated with Harbor Defense Armament under the command of the Harbor Defense Commander.

"The maintenance, supply, administration and discipline of Harbor Defense troops assigned to the fixed AA armament and associated AA Searchlights is a function of the Harbor Defense Commander.

"The automatic AA weapons assigned to fixed or mobile Harbor Defense armament, Seacoast, will be coordinated with similar weapons under the control of the AAA Command, located in adjacent areas.

"The following fixed AA armament and associated Searchlights in the Harbor Defenses of New York is manned as indicated:

3" AA

Btry #1 Ft. Hancock, N.J.-

Btry #2 Ft. Hancock, N.J.

Btry #3 Ft. Tilden, N.Y.

AA Searchlights

7 Ft. Hancock, N.J.

Btry "A" 245th CA.

Btry "B" 245th CA.

Btry "F" 7th CA.

Btry "C" 245th CA.

"The following fixed AA armament and AA Searchlights now manned by 701st CA (AA) will be taken over by the Harbor Defense Personnel by March 15, 1943:



3" AA Btry, Ft. Wadsworth  
3" AA Btry, Ft. Hamilton  
3" AA Btry, Ft. Totten  
5 AA Searchlights assigned to Btry "C" 245th C.A.  
5 AA Searchlights assigned to Btry "G" 7th C.A.

"The above armament and lights to be taken over from the 701st C.A. (AA)

"The Searchlight locations to be as indicated by the 38th Brigade, C.A. (AA)

"The Searchlight Batteries 245th C.A. and 7th C.A. each to be increased by 69 enlisted men and 1 officer, to man additional assignments.

"Reassignments of personnel within the Harbor Defense will be completed by March 12, 1943, to facilitate the transfer of property and provide a short period during which Harbor Defense personnel may operate this equipment under the supervision of the 701st C.A. (A.A.)."

This action was taken by Sector, directing Subsector to reassign armament in order to replace the 701st CA (AA), to conform to a policy stated previously by the Eastern Defense Command and First Army which we quote:

"It is considered imperative that all antiaircraft armament within the Harbor Defenses of New York be manned, regardless of the effect such policy has on the manning of seacoast armament."

The system of Army Liaison Detachments being placed with Coast Guard installation as a further means of close contact between the elements of coastal defense was inaugurated in February, 1943 after a series of conferences between the Commanding General, New York-Philadelphia Sector; the Commanding General, New York Subsector and the Commanding General, 113th Infantry Combat Team with the Commander, Coast Guard Patrol Force. Third Naval District.

On 10 February 1943 these locations were operating:

Napeague Life Boat Station  
Georgica Life Boat Station  
Southampton Barracks  
Quegue Life Boat Station  
New Moriches Life Boat Station  
Fire Island Life Boat Station  
Short Beach Life Boat Station  
Long Beach Life Boat Station

(116)

SECRET

Atlantic Beach Life Boat Station  
Averne Barracks

On 12 February 1943 these locations were operating:

Ditch Plain Life Boat Station  
Amagansett Barracks  
Bridghampton Barracks  
Shinnecock Life Boat Station  
Tiana Life Boat Station  
Potunk Lookout station  
Point Lookout Lifeboat Station

On 15 February 1943 these locations were operating:

Sea Bright Barracks  
Monmouth Beach Life Boat Station  
Long Branch Barracks  
Deal Life Boat Station  
Shark River Life Boat Station, Spring Lake Life Boat Station  
Sea Girt Light Station

A number of changes were to come early in 1943. A reorganization of the elements of the Harbor Defenses of New York were in the making to conform with the benefits sought in the abolishing of the separate harbor defenses in favor of the single harbor defense. The analysis of this problem and its proposed solution is best expressed in a memorandum by Colonel Albert M. Jackson to the Commanding General, New York-Philadelphia Sector dated March 6, 1943 as follows in part:  
(Ref. 320/116)

1. The purpose in proposing the activation of the Harbor Defenses of New York was to provide an opportunity of organizing the various defensive elements covering New York Harbor inot a tactical and administrative command the interior organization of which would provide the most effective utilization of the project armament sited for the defense of New York Harbor.

2. The approval by the War Department of the activation of the Harbor Defenses of New York provided the opportunity sought but the latitude provided by such authorization has not, it is believed, been fully accomplished because in general the interior organization has remained substantially the same as it was before the activation of the Harbor Defenses of New York.

3. The ultimate physical character of the harbor defenses is rapidly taking shape. The firing batteries are rapidly becoming completed. An entirely new fire control system has been designed and the elements of this system are being provided as fast as engineering will permit. With the completion of the construction authorized in the 1943 program, the batteries will be provided with a complete, modern fire control system.

4. After the completion of the firing batteries, including their fire control system, the next logical step appears to be the provision of the physical facilities necessary to accomplish the functions of the higher commanders such as the group, groupment, and harbor defense. The provisions of these facilities involves durable and consequently costly construction, hence before attempting to provide these facilities, their justification must be established. We must soon be prepared to submit an expenditure program for fiscal year 1944 and we must seize this opportunity to obtain the authorization to complete the physical facilities necessary to the exercise of the higher command functions. To justify the necessity for these facilities, an organization plan based on sound tactical principles must be established and approved by higher commanders. For the reasons stated, it appears urgent at this time to determine whether the existing organization permits the employment of the armament at its maximum effectiveness; and, in the negative case, to determine the character of an organization which will permit the employment of this costly plant at its maximum effectiveness.

5. In examining any scheme of organization, certain basic principles must always be borne in mind. It is considered pertinent to cite some of these, such as:

"A military organization is a group of troops operating as a unit under a leader or commander, and performing a particular duty or class of duties."

"If a number of organizations are engaged in performing the same duty, teamwork will be secured by placing them under a single commander. On the other hand, administration, supply and training can often be handled most efficiently by keeping units in the same area under the same control. This factor may require that a unit be included in one organization for one purpose and in a different organization for another."

6. A harbor defense commander's tactical responsibilities may roughly be divided as follows:

a. Seaward defense, or the employment of weapons against surface or underwater craft.

b. Air defense, or the employment of weapons against aircraft. While the fixed AA artillery is at the present under operational control of another agency,

the harbor defense commander must still have a live interest in it because he may be called upon at any moment to resume control of this armament.

g. Local security. This is a responsibility inherent in all command echelons and, in the case of a harbor defense, it can generally be handled by local administration commanders such as fort commanders.

7. a. SEWARD DEFENSE In the case of the Harbor Defenses of New York the seaward defense can be subdivided as follows:

- (1) Distant defense involving the employment of long and medium range artillery. This defense falls naturally into two general subdivisions, as follows:
  - (a) The distant approaches to the harbor from the east.
  - (b) The distant approaches to the harbor from the south.
- (2) Close-in defense involving the defense of the lower harbor and its immediate approaches by:
  - (a) Long and medium range 6" guns.
  - (b) Rapid fire batteries, principally 90 mm. and automatic weapons.
  - (c) Submarine mines.

b. AA DEFENSE Within a harbor defense all antiaircraft artillery will normally be grouped into an antiaircraft groupment or separate group. (Par. 40 b., FM 4-5.) In the case of the Harbor Defenses of New York where the control of the AA artillery is resumed by the harbor defense commander no reasons are apparent for a deviation from this established principle.

8. In accordance with the principles cited in paragraph 5; the definitions of harbor defense, groupment, and group; and the breakdown of the harbor defense commander's responsibilities as indicated in paragraph 7; this headquarters proposed an organization of the Harbor Defenses of New York involving the following subdivisions of responsibility:

a. Delegation of the harbor defense commander's tactical responsibilities to:

- (1) A gun group commander responsible for the long and medium range artillery sited to cover the southern approaches, as follows:

Battery Lewis, 2-16"  
Battery Mills, 2-12"  
Battery Kingman, 2-12"  
Battery Const. No. 219, 2-6" long range  
Battery Peck, 2-6" medium range

There appears to be no argument grouping the 16" and 12" batteries together. The long range 6" battery, although of different caliber, falls into this group due to its location. Battery Peck falls into the same group because it is more closely associated with this group

than with any other subdivision unless it should be classified as a separate battery/.

- (2) A gun group commander responsible to the long and medium range artillery sited to cover the eastern approaches, as follows:

Battery Harris, 2-16"  
Battery Const. No. 220, 2-6" long range  
Battery Kessler, 2-6" medium range.

This is a 6" group with a separate battery assigned.

- (3) A groupment commander responsible for the security of a well-defined water area and its immediate approaches. It is proposed to designate this entity as the Ambrose Groupment as this appellation appears to conform closest to the requirement of par. 52 FM 4-5. This groupment, roughly the equivalent of a CA regiment, is proposed to be subdivided as follows:

- (a) A gun group consisting of the 2-6" batteries at the Narrows.  
(b) A mine group to operate the underwater defense project.  
(c) n and 3" armament sited  
guns maximum)  
nn and 3" armament sited  
and Long Island. (8-90mm

- (4) An AA Group commander responsible for the AA artillery in the harbor defenses whenever the control of the same is vested in the harbor defense commander.

- (5) A commander responsible for the seacoast armament at Fort Totten.

b. Delegation of the harbor defense Commander's administrative responsibilities to Fort Commanders who, in addition, have tactical responsibilities as follows:

Fort Commander, Fort Hancock, would be Ambrose Groupment Commander.  
Fort Commander, Fort Tilden, would be gun group commander  
Fort Commander, Fort Wadsworth, would be a gun group commander.

This is in conformity with par. 63 FM 4-5

This ends the quotation from Colonel Jackson's memorandum.

The result of this planning is perhaps best illustrated by organization of the Harbor Defenses of New York in the Plate No. 14 chart that which accompanied General Orders No. 4, of that headquarters, which was effective 4 May 1943.

Basically this organization held until this writing, February 1944.

Colonel J. R. Lowder assumed command of the Ambrose Groupment with his assumption of command of the 245th Coast Artillery (HD) by General Orders 20 May 1943, succeeding Colonel Carl J. Smith as Commanding Officer of the 245th CA. Colonel Lowder was succeeded by Colonel J.C. Haw as Commanding Officer of the 245th CA and the Ambrose Groupment 28 August 1943. Colonel Haw was still commanding in February 1944.

Other changes that occurred during this period effecting the command of New York Subsector have been treated in "Sector in Operation" (Section II, Part 1) since they involved changes in Sector as a whole. They include:

The divorcement of certain units 115th Infantry Combat Team from Subsector Control, effective March 17, 1943. (Pages )

The activation of Subsector Headquarters and Headquarters Detachments, effective 1 September 1943. (Pages )

The change in territorial organization of troops within Sector in which the 115th Regimental Combat Team as a whole was removed from attachments to subsectors and placed under the control of the Commanding General, New York-Philadelphia Sector, 1 November 1943. (Pages )

In connection with the divorcement of certain units of the 113th Infantry Combat Team from Sunsector control certain "temporary" changes in station were effected by a movement dated 10 March 1943. In these orders the following units were ordered from station at Fort Hancock, N.J. to the stations indicated below.

(Ref. 370.6/135)

<u>UNIT</u>	<u>TO</u>
Hq 113th Infantry	Ft. Hamilton, N.Y.
Hq Company, 113th Infantry (less detachments)	Ft. Hamilton, N.Y.
Service Co, 113th Infantry (less Detachments)	Ft. Hamilton, N.Y.
Medical Detachments, 113th Infantry (less detachments)	Ft. Hamilton, N.Y.
671st Col. Co. (Sep) (less detachments)	Ft. Hamilton, N.Y.
Hq. 199th FA BN (less detachments)	Ft. Hamilton, N.Y.
Hq 2nd Bn, 132nd Engrs. (less detachments)	Ft. Hamilton, N.Y.
Band, 113th Infantry	Freehold, N.J.

**LEGEND**  
 Command \_\_\_\_\_  
 Emergency Command \_\_\_\_\_  
 Temporary Command x\_x-x-x-x-  
 Command Lost \_\_\_\_\_  
 1 November 1943 0000000000

NY-P  
SECTOR

NEW YORK  
SUBSECTOR

00000000

113th  
Inf. BCT

H.D.  
NEW YORK

C-1  
AMBROSE GRP.

38th  
BRIGADE

H E C P

G-1  
Hancock  
Const 219  
2-6"  
  
Lewis  
2-16"  
  
Mills  
2-12"  
  
Kingman  
2-12"  
  
Peck  
2-6"  
  
Searchlights  
  
Ry. Btry.  
4-8"

G-2  
Tilden  
  
Advanced  
HECP #2  
Tilden  
  
Kessler  
2-6"  
  
Harris  
2-16"  
  
Const. 220  
2-6"  
  
Searchlights

G-3  
Hancock  
Mines  
Hancock  
  
Mines  
Tilden  
  
Mines  
Wadsworth

G-4  
Hancock  
  
Advanced  
HECP #1  
Hancock  
  
Urnston  
2-3"  
  
South  
2-90mm  
  
North  
2-90mm  
  
Norris  
4-3"  
  
Searchlights

G-5  
Norton Pt.  
Miller Fld.  
2-90 mm  
  
Swineburne  
2-90 mm  
  
Turnbull  
4-3"  
  
Griffin  
2-3"  
  
Catlin  
4-3"  
  
Nortons Pt.  
2-90 mm  
  
Rockaway Pt.  
2-3"  
  
Rockaway Pt.  
2-90 mm  
  
Searchlights

G-6  
Wadsworth  
Const. 218  
2-6"  
  
Livingston  
2-6"

G-7  
A. A.  
3-3"  
(Hancock)  
  
3-3"  
(Hancock)  
  
3-3"  
(Wadsworth)  
  
3-3"  
(Hamilton)  
  
3-3"  
(Tilden)  
  
3-3"  
(Totten)  
  
A A  
Searchlights

G-8  
Totten  
Baker  
2-3"  
  
Burns  
2-3"  
  
Searchlights

SECRET

SECRET

PLATE  
7  
11

The movement of the 113th Infantry Band was to be completed by 17 March 1943 and the movement of all other elements by 19 March 1943.

The removal of the 199th Field Artillery Battalion, Hq Battery and Service battery was directed in a movement order dated 12 March 1943 when these units of the 113th Infantry Combat Team was ordered to proceed by organic motor transportation from Fort Hancock, N.J. to Fort Hamilton, New York. The movement was described as a temporary change of station and was to be completed on 19 March 1943.

Both movement orders contained this paragraph:

Upon arrival at new stations these units are relieved from attachment to the New York Subsector and are placed under the control of the Commanding General, New York-Philadelphia Sector."

Also during the summer of 1943 as the modernization program drew near realization and less need was felt for certain classes of armament, more batteries were relegated to class "B" status. By authority, 1st Ind., Headquarters Eastern Defense Command and First Army, dated 23 July 1943 on letter, Headquarters New York-Philadelphia Sector, dated 3 July 1943, the following batteries were placed in class "B": (Ref. 230.31/120)

Battery No. 20, 2-3" BC, Hookaway Point (New Battery Catlin)  
Battery Urmston, 2-3" BC, Fort Hancock (relocated)  
Battery Burns, 2-3" BC, Fort Totten  
Battery Griffin, 2-3" BC, Fort Hamilton  
Battery Livingston, 2-5" BC, Fort Hamilton

By November 1943 a number of factors contributed to the decision to remove several batteries in the Harbor Defenses of New York. These batteries were outmoded and their greatest use had been as training batteries for the influx of new troops. This condition did not obtain any longer.

So by 1 November 1943 the modernization was considered far enough advanced, the military situation secure enough, and the usefulness as training factors re-



moved to such extent that the batteries could be considered no longer essential and "in view of the fact that personnel is not available to man the batteries". Therefore New York-Philadelphia Sector asked that the following guns in the Harbor Defenses of New York be eliminated and transferred to the Second Service Command for salvage:

At Fort Hancock - Batteries Richardson and Bloomfield, both 2-gun, 12" DC Batteries.

At Fort Wadsworth - Battery Dix, 2-gun, 12", DC, and Battery Mills, 1-gun, 6", DC battery.

At Fort Hamilton - Battery Johnson, 2-gun, 6", DC battery and Batteries Brown and Doubleday, both 2-gun, 12", DC batteries.

Direction that necessary action for their disposal was directed by the Chief of Staff, Operations Division, War Department General Staff 9 November 1943. (Ref. 660.2/95)

By December 1943 the 7th Coast Artillery at Fort Hancock was involved in another redesignation of units, this time with the 5th Coast Artillery. The redesignation was not as broad in scope as that which involved the redesignation of battalions in the case of 245th Coast Artillery little more than a year ago. In this case it was batteries.

It was an exchange of identities of "B" of the 5th CA and "E" of the 7th in which Battery "B" of the 5th CA was redesignated Battery "E" of the 7th CA and Battery "E" of the 7th CA was redesignated Battery "B" of the 5th CA, effective 10 January 1944 by direction of Special Orders No. 221, Harbor Defenses of New York, dated 28 December 1943. Both batteries were at Fort Hancock so no change of station was involved.

As the year 1943 came to an end the New York Subsector had been stripped

of most of its functions as such especially due to the removal of Subsector command over the Infantry Combat Team battalions. Its scope had narrowed to virtually the identical command of the Harbor Defenses of New York.

Therefore with the reorganization of New York-Philadelphia Sector, Chesapeake Bay Sector and Southern Sector into Southeastern Sector in January and February of 1944, the New York Subsector was eliminated from planning. The Harbor Defense remained however and carried on as an element of command of the new Southeastern Sector.

One of the first signs of the adjustments ahead were shown Special Orders No. 25, Headquarters Eastern Defense Command, dated 7 February 1944 in which Brigadier General Philip S. Gage "is released from duty as Commanding General, Harbor Defenses of New York, Fort Hancock, N.J. and is assigned as Commanding General, Harbor Defenses of Boston, Fort Banks, Mass., effective 1 March 1944."

The units under command of New York Subsector and Harbor Defenses of New York at the beginning of February 1944, the final days of Subsector, and their stations, were as follows:

NEW YORK SUBSECTOR

Hq Det NYSS	Fort Hancock, N.J.
<u>Harbor Defenses of New York, Hq and Hq Btry</u>	Fort Hancock, N.J.
HECP, HDNY	Fort Wadsworth, N.Y.
Advanced HECP No. 1	Fort Hancock, N.J.
Advanced HECP No. 2	Fort Tilden, N.Y.
7th CA (HD) Hq and Hq Btry & Med Det	Fort Hancock, N.J.
1st Battalion, Hq Btry	Fort Hancock, N.J.
Btry A	Fort Hancock, N.J.
Btry B	Fort Hancock, N.J.
Btry C	Fort Hancock, N.J.
2nd Battalion, Hq Btry	Fort Hancock, N.J.
Btry D	Fort Hancock, N.J.
Btry E	Fort Hancock, N.J.

Btry F	Fort Totten, N.Y.
Btry D (less Det)	Fort Hancock, N.J.
Det Btry D	Fort Totten, N.Y.
245th CA (HD) Hq and Hq Btry & Med Det	
Band, 245th CA	Fort Wadsworth, N.Y.
1st Battalion, Hq Btry	Fort Hancock, N.J.
Btry A	Fort Hancock, N.J.
Btry B	Fort Hancock, N.J.
Btry C	Fort Hancock, N.J.
2nd Battalion, Hq Btry	Fort Wadsworth, N.Y.
Btry D	Fort Hancock, N.J.
Btry E	Swinburne Is. Fort Wadsworth, N.Y.
Btry F	Fort Hancock, N.J.
3rd Battalion, Hq Btry	Fort Hancock, N.J.
Btry G	Fort Tilden, N.Y.
Btry H	Fort Tilden, N.Y.
Btry I	Fort Tilden, N.Y.
4th Battalion, Hq Btry	Fort Tilden, N.Y.
Btry K	Mortons Point, N.Y.
Btry L	Miller, Field, N.Y.
Btry M	Mortons Point, N.Y.
Btry N (less AA Plat)	Reckaway Point, N.Y.
AA Plat, Btry N	Fort Wadsworth, N.Y.
	Fort Tilden, N.Y.
5th CA (HD) Hq and Hq Btry & Med Det	
Btry A	Fort Tilden, N.Y.
Btry B	Fort Wadsworth, N.Y.
Btry D	Fort Hancock, N.J.
	Fort Tilden, N.Y.
288th CA (Ry) Bn, Btry A	Fort Hancock, N.J.
5th CAMP Btry, USAMP "Gen Ord"	Army Base, Bklyn, N.Y.
15th CAMP Btry, USAMP "Story"	Fort Jay, N.Y.
20th CAMP Btry, USAMP "Mayback"	Tompkinsville, S.I.

## HARBOR ENTRANCE CONTROL POST

### New York Subsector - Harbor Defenses of New York

The Harbor Entrance Control Post, or posts, for the New York Harbor have a peculiar history of their own. To trace it through the development of other elements of the development of the New York Subsector may be confusing and for that reason it is isolated here.

It was realized very early that the operation of a joint harbor entrance control post (HECP) for New York Harbor presented a peculiar problem that could not be met by a single control post. This opinion was expressed in a report on tests by the Third Naval District and the Second Coast Artillery District made on July 8, 1941 at the request of First Army. (Ref. 381/25 NET x 267,4)

It was noted that two harbor defenses (the Harbor Defenses of Southern New York and Sandy Hook) controlled the main approaches to New York Harbor with the New York Subsector commanding both. The command post being at Fort Wadsworth and the consideration of liaison with Navy elements made it logical to select Fort Wadsworth for the site of the HECP from the standpoint of joint operation. However this location on Staten Island, and - in fact - no one location, could provide terrestrial observation of the entire defensive coastal area, the report pointed out. The solution, it was decided, was to provide for observation from three localities, Sandy Hook, Fort Tilden and the Narrows. Examination areas, it was pointed out, could be designated by the Navy under coverage of guns of Fort Tilden and Fort Hancock.

The conclusions were reached after study of results of several tests and exercises held in conjunction with the Navy and old Fort Tompkins at Fort Wadsworth

was selected as an efficient site for a central HECF (Ref. 381/26 NET). At this no continuous operation of HECF was contemplated by Second Coast Artillery District and four officers were designated for its operation and to conduct tests to determine future operational policy on June 13, 1941. (Ref. 381/28 NET) Two from the Harbor Defenses of Sandy Hook were Majors Charles A. Zello of the 245th CA and Walter K. Porzer, 52nd CA, and two from the Harbor Defenses of Southern New York were Captains Russell O. Utke and Daniel A. Hopper, both of the 5th CA.

As the war situation showed no signs of easing the order for part time operation was rescinded and on July 31, 1941 General Orders No. 12, Headquarters, Second Coast Artillery District, amended General Orders No. 8, same headquarters, to read that all HECFs will be placed in continuous operation on a twenty-four hour basis, commencing at 12:00 noon, 1 August 1941. The New York HECF was operated by the Second Coast Artillery District as compared to the Delaware Bay HECF which was to be operated by the Commanding Officer, Harbor Defenses of the Delaware. (Ref. 381/45a NET)

The Navy concurred in general with the plan for sites for observation and HECF operation (Ref. 381/32) and the inclusion of the HECF at Fort Wadsworth in the project for the Harbor Defenses of New York was approved by War Department indorsement September 24, 1941 on a letter of July 10, 1941 - AG 350.07/35; OCCA 660.3/30-A. The approved cost for the project was placed at \$7500.00. (ref. 660.3/30 A-1)

However a lot of wrinkles still had to be ironed out of the HECF program. Although the HECF at Fort Wadsworth, which was located at old Fort Tomkins, had been in operation on a training basis since May 1941 the post without proper power for in October 1941 the Navy was making a request for such electric power

which, "when supplied would find the post ready for war operation." (Ref. 391/45n  
NET)

But the HECP was getting to be an efficient machine recognized as a success by both Army and Navy. On 24 September 1941 the then Harbor Defenses of Sandy Hook were ordered to make all reports on naval and merchant vessels to HECP and not to the Headquarters Second Coast Artillery District as this observation point had previously been doing. Also, on 30 October 1941, the Third Naval District announced the operation of the HECP at Fort Wadsworth and advised, "all vessels approaching the narrows are required to answer signals from this station."

The New York Harbor Entrance Control Post was a going concern more than a month before the outbreak of World War II.

However there was still a lack to be overcome, that of the lack of seaward observation from Fort Wadsworth. The single HECP was ideally located for control of shipping coming through the narrows but observation from the entrance to the outer harbor still to be desired. A signal station at Fort Hancock on Sandy Hook helped to fill this gap but it was felt that the system of control needed some closer knit organization.

The solution of this problem of effectively covering New York Harbor with harbor entrance control posts was offered by the Joint Army and Navy planning Committee, Eastern Defense command was offered by the committee in its report of 24 February 1943. To quote, in part, from the minutes of the committee:

".... It was the unanimous opinion of the committee that the only logical solution of the HECP location problem would be:

"Retention of the present HECP station at Ft. Wadsworth on its present full operating basis.

"Establishment of stations at Ft. Hancock and Ft. Tilden to be designated

as advanced HECP's numbers 1 and 2, respectively. The one at Ft. Hancock to be established in the erstwhile (provisional) HECP (present signal station). The one at Ft. Tilden to be established at some point on the Rockaway peninsula after proper survey and agreement between local Army and Navy authorities as to best exact location.

"The relation between the three HECP's (present one at Ft. Wadsworth and advanced ones at Ft. Hancock and Ft. Tilden) shall be that of 3 separate stations maintaining local ship plots, with full control of shipping in contiguous waters, and with general supervision vested in the central HECP at Ft. Wadsworth."

Defense Command Headquarters ordered these recommendations carried out in a letter of March 11, 1943 and in a first indorsement March 13, 1943 which directed:

"The system of Harbor Entrance Control Posts, Harbor Defenses of New York, as described ..... , will be established. This headquarters will confer with the Headquarters of the Commandant Third Naval District relative to the Character and location of the establishment (on Rockaway peninsula) described." (Ref. 381/110 NET)

The "new" advanced HECP No. 2, Fort Tilden, was manned effective 6 August 1943.

But the personnel for these "extra" HECPs was another question. Three Harbor Entrance Control Posts for the Harbor of New York were required to meet the demands of the local situation but only one HECP for one harbor entrance was the rule under which they were organized. The situation is best illustrated by an exchange of correspondence on the subject in June 1943 between the Harbor Defenses of New York and New York-Philadelphia Sector.

Authority was requested on June 1, 1943 to activate two additional Harbor Entrance Control Post Sections within the Headquarters and Headquarters Battery, Harbor Defenses of New York, for the purpose of providing additional personnel to man all three Harbor Entrance Control Posts.

The authority of T/O #4-260-1, dated April 1, 1942 states that where more

than one entrance exists, one Harbor Entrance Control Post section is authorized for each entrance. It was argued in the letter, however that "while there is only one entrance to the New York Harbor, this headquarters (Harbor Defense of New York), is, in fact, required to man and operate 3 Harbor Entrance Control Posts pursuant to joint agreement between the Army and Navy Commanders contained in 'Minutes of Joint Army and Navy Planning Committee EDC, ' dated February 24, 1943."

This plea was refused by Sector since "the War Department will not authorize additional personnel for Harbor Defense Installations," in a letter dated 7 June 1943, which advised further:

"It is the opinion of this headquarters (Sector) that advanced H.E.C.P. No. 1 should be manned by personnel drawn from the Headquarters and Headquarters Battery of the battalion assigned to Group 4, and that Advanced H.E.C.P. No. 2 be manned by personnel drawn from the Headquarters and Headquarters Battery of the battalion assigned to group 5. In addition, personnel in Headquarters and Headquarters Battery, Harbor Defense of New York, and the Headquarters Battery of the parent regiment are available." (Ref. 320/135)

The Harbor Entrance Control Posts of New York Harbor were still operating on this basis in February 1944, fulfilling the mission of standing guard, Army and Navy, over the entrance to the World's busiest port.



DESCRIPTIONS  
of  
FORTS AND ARMAMENT  
(Harbor Defenses of New York)

**KEY** The fixed batteries of the various forts in the Harbor Defense have been listed in tabular form for easy reference and keyed to avoid repetition of general information. The original list was taken from a list of batteries as they existed in the Second Coast Artillery District 15 July 1939 when all the armament was classified as "in commission, out of service, caretakers" status.

The following symbols used, with their interpretations, are:

- (s) To be provided with a shield as a project of the modernization program.
- (c) To be casemated as a project of the modernization program.
- (e) Outmoded battery to be abandoned upon completion of new batteries in the modernization program.
- (n) No longer required in the Harbor Defense project.
- (NC) New Construction.
- \* According to listing in supplement to project, Harbor Defenses of New York, dated 1943.
- \*\* Reverted to Class "A" only for training purposes upon attachment of 265th CA.
- # According to NYPPER-THREE dated 15 July 1943.
- ## As a matter of policy all 90mm AMTB batteries in the harbor defenses constituted two fixed and two mobile guns, with the exception of one battery on Swinburne Island, N.Y. The fixed mount was T-3 and the mobile M1A1. All mobile batteries were removed from the sites in local ordnance storage by order of New York-Philadelphia Sector 18 December 1943. All AMTB batteries after that date constituted two fixed guns only.

F O R T H A N C O O K , N . J .

Fort Hancock is named in honor of the memory of Major General Winfield Scott Hancock, US. Army, who served with distinction in the Mexican War and the Civil war, and who died 9 February 1886. It was named Fort Hancock 30 October 1895, having previously been known as the Fortifications<sup>o</sup> of Sandy Hook.

The Fort is situated on Sandy Hook, New Jersey guarding the outer entrance to New York Harbor. The first parcel of land for the site was acquired by the Government in 1762 at that time for a lighthouse, and additional parcels were subsequently acquired until the reservation was expanded to its present size.

Construction of the actual fortifications began in 1890 on the site of the old mine casemate that dated from 1880. The permanent garrison was not established until 1898 under command of Lieutenant Colonel Tully McGree of the Fifth Artillery.

BATTERIES

<u>Name</u>	<u>Cal.</u>	<u>No. &amp; Mod.</u>	<u>Car.</u>	<u>Notes</u>
LEWIS (NC) (Const. 116)	16"	2-MK2M1	BC	Located at Navesink Highlands. Range 44,000 yards.* Under construction 1 June 1942. Proof fired 29 December 1943. Status January 1944 - Class "A".# To be retained.*
KINGMAN (c)	12"	2-1895M1	BC	Range 29,300 yards.* Work on casemating started 12 August 1941. Casemating is completed by 30 April 1942. In Class "B" 14 November 1942.** Status January 1944- Class "C".# To be retained.*
MILLS (c)	12"-	2-1895M1	BC	Range 29,500 yards.* Work on casemating started 13 April 1942. Casemating completed by 31 October 1942. In Class "B" 14 November 1942.** Status January 1944- Class "C".# To be retained.*
RICHARDSON (c)	12"	2-1895M1	DC	Restored to Class "A" 1 June 1941. In first preventative August 1942. In Class "C" 3 November 1942.** Disposal authorized 9 November 1943. Status January 1944 - Dismantled.

HANCOCK BATTERIES  
(Cont'd)

<u>Name</u>	<u>Cal.</u>	<u>No. &amp; Mod.</u>	<u>Car.</u>	<u>Notes</u>
BLOOMFIELD (o)	12"	2-2888M1	DC	Reverted from Class "C" to Class "A" 12 June 1941. In rust preventative Aug. 1942. In Class "C" 3 November 1942.** Disposal authorized 9 November 1943. Status January 1944 - Dismantled.
ALEXANDER (n)	12"	2-1888M2	DC	Class "C" in 1941. Ordered turned over to ordnance for salvage 12 November 1942. Status January 1944 - Dismantled.
GRANGER (n)	10"	1-1888M2 1-1888M1	DC	In process of being turned over to ordnance 30 Dec. 1941. Status January 1944 - Dismantled.
HALLECK (n)	10"	1-1888 1-1888M1	DC	Class "C" in 1941. Ordered turned over to ordnance for salvage November 1942. Status January 1944 - Dismantled.
CONST. 219 (NC)	6"	2-1903A2	BC	Located at Navesink Highlands. Range 27,500 yards. Under construction by 8 July 1942. Proof fired 28 August 1943. Status January 1944 - Class "A".# To be retained.*
PECK (s)	6"	2-1900	BC	Range 17,000 Yards.* In Class "A" in 1941 Relocated on site of Battery Gunnison summer of 1943. Status January 1944 - Class "A".# To be retained.*
GUNNISON (o)	6"	2-1903	DC	Class "A" in 1941. Placed in Class "C" 3 November 1942. Work of dismantling started 8 March 1943. Status January 1944 - Dismantled. (Battery Peck relocated on site of emplacement of Battery Gunnison)
URMSTON (s)	3"	2-1903	RF	Range 11,000 Yards.* In Class "A" in 1941. Relocated at Ft. Hancock by end of 1942. Authorized Class "B" 23 July 1943. Status January 1944 - Class "C".# To be retained.*

HANCOCK BATTERIES  
(Cont'd)

<u>Name</u>	<u>Cal.</u>	<u>No. &amp; Mod.</u>	<u>Car.</u>	<u>Notes</u>
MORRIS (s)	3"	4-1903	RF	Range 11,000 yards.* In Class "A" in 1941. Status January 1944 - Class "C".# To be retained.*
AMTB No. 1 (NC)	90mm	4-M1	(#)	Range 8000 yards. Battery manned as of 28 January 1943. Class "A" armament (two fixed guns). Status January 1944 - Class "A".# To be retained.*
AMTB No. 2 (NC)	90mm	4-M1	(#)	Range 8000 yards. Battery manned as of 28 January 1943. Class "A" armament (two fixed guns). Status January 1944 - Class "A".# To be retained.*
AA no. 1	3"	3-1917A2	AA	Antiaircraft batteries Class "A" until 26 November 1943 when all fixed 3-inch AA Batteries changed from Class "A" to Class "C". Status January 1944 - Class "C".#
AA No. 2	3"	3-1917A2	AA	Antiaircraft batteries Class "A" until 26 November 1943 when all fixed 3-inch AA Batteries changed from Class "A" to Class "C". Status January 1944 - Class "C".#

-000-

F O R T T I L D E N, N. Y.

Fort Tilden was named in honor of the memory of Samuel Jones Tilden, former Governor of New York and who, in 1876, was the Democratic nominee for the Presidency of the United States.

The fort is situated on Rockaway peninsula, Queens County, Long Island, New York and the land acquired officially by the Government from the State of New York for \$705,000 on 1 May 1917. The amount of land purchased was 317 acres.

The actual construction of the fort was started in February 1917 and was first called Fort Funsten in recognition of General Funsten who had led the punitive expedition into Mexico following the reign of banditry along the border. Its name was changed to Fort Tilden 1 August 1917.

BATTERIES

<u>Name</u>	<u>Cal.</u>	<u>No. &amp; Mod.</u>	<u>Car.</u>	<u>Notes</u>
HARRIS (o)	16"	2-1919M2	BC	Range 44,680 yards* Manned and Class "A" in 1941. Casemating started in October 1941 and completed by 17 June 1942. Class "B" 1 March 1943. Reverted to Class "A" 30 June 1943. Status January 1944 - Class "A".# To be retained.*
CONST. 220 (NC)	6"	2-1903AZ	BC	Range 27,500 yards.* Work started 5 October 1942 replacing current project battery Fergusson. Status January 1944 - Still under construction (expected to be completed by April 1944). To be retained*
FERGUSSON (o) (East)	6"	2-1900	BC	Range 17,000 yards.* Class "A" in 1941. Status January 1944 - Class "A".# Temporary until completion of Const. 220.

TILDEN BATTERIES  
(Cont'd)

<u>Name</u>	<u>Cal.</u>	<u>No. &amp; Mod.</u>	<u>Car.</u>	<u>Notes</u>
KESSLER (s)	6"	2-1900	BC	Range 17,000 yards.* Class "A" in 1941. Construction on shields started 25 Oct. 1941 when "work to continue three or four months" with guns still in action. Status Jan. 1944 - Class "A".# To be retained.*
AMTB (NC) (Rockaway)	90mm	4-M1	(##)	Range 8000 yards. manned February 1943 according to NYPPER-ONE dated 18 Feb. 1943. Manned as Class "A". Status Jan. 1944 - Class "A".# To be retained.*
Number 20 (Rockaway)	3"	2-1902	RF	Created from two guns of Battery Catlin emplaced 14 April 1942. Manned as Class "A" armament. Class "B" 18 September 1943. Status January 1944 - Class "C".# To be retained.*
AA Number 5	3"	2-1917AZ	AA	Manned and Class "A" until 26 November 1943 when all 3-inch fixed AA Batteries changed from Class "A" to "C". Status January 1944 - Class "C".#

---

NOTE: Construction 117, which was to be a 16-inch battery of 2 guns, which was to be located on the Long Island Shore in the vicinity of the Jamaica Sea Airport, was in the project until 13 November 1942 when the War Department, file AG 660.2 (11-12-42) OE-S-E, eliminated it with eight others in the Eastern Defense Command "in order to place this (modernization) program in a workable condition and to effect a reduction in the requirements for seacoast batteries in line with the acute shortage of critical materials ..."  
(Ref. Modernization File)

F O R T W A D S W O R T H, S. I., N. Y.

Fort Wadsworth on Staten Island, N.Y., located so it commands the Narrows between the entrance to New York Harbor and the Upper Bay with Fort Hamilton on the opposite Breoklyn shore, is named in honor of the memory of Brigadier General James S. Wadsworth who was killed in the Wilderness Battle in 1864.

Many military garrisons, both Dutch and English, had occupied sites on Staten Island in the general location of Fort Wadsworth in the early days of the colonization of America. General Washington used a post on the Staten Island shore to signal news to New York City of the arrival of the British fleet carrying General Howe's army during the Revolutionary War.

Fort Wadsworth as it exists today had its beginnings in 1847 when the United States Government began to purchase land on which the Fort stands. The erection of the present Fort Tompkins and the then Battery Weed, now both included in the confines of Fort Wadsworth, was begun in 1864. The last land acquired for the Fort was purchased during the years 1892 to 1902 which was the area west of New York Avenue.

BATTERIES

<u>Name</u>	<u>Cal.</u>	<u>No. &amp; Mod.</u>	<u>Car.</u>	<u>Notes</u>
DIX (e)	12"	2-1900	DC	Named in honor of the memory of Major General John Adams Dix, U.S. Volunteers, who served with distinction in Artillery, in the Civil War, was U.S. Senator, 1845 to 1849 and Governor of the State of New York 1872. Died 21 April 1879. The battery was manned when Turnbull and Catlin was not manned in 1941. Placed in Class "B" 5 November 1942. Turned over to Ordnance according to NYPPER 18 February 1943. Disposal authorized 9 November 1943. Status January 1944 - To be dismantled.
AYERS (n)	12"	2-1888M2	DC	Named in honor of the memory of Colonel Remeyn Beck Ayers, 2nd U.S. Artillery, who served with distinction in the Civil War and died 4 December 1888. Battery ordered transferred to Ordnance Officer, 2nd Service Command for salvage 12 Nov. 1942. Dismantled by January 1943.

WADSWORTH BATTERIES  
(Cont'd)

<u>Name</u>	<u>Cal.</u>	<u>No. &amp; Mod.</u>	<u>Car.</u>	<u>Notes</u>
HUDSON (n)	12"	2-1988M2	DC	Named for the "old earth battery" that was located on the same site. Disposal of battery same as Battery Ayers.
RICHMOND (n)	12"	2-1888M2	DC	Named for old Fort Richmond as the fortification included in what is now Fort Wadsworth was formerly known. The name is derived from Richmond County, S.I.N.Y. Disposal of battery same as Battery Ayers.
UPTON (n)	8"	2-1888	DC	Named in honor of memory of Colonel Emory Upton who served with distinction in Civil War and who died 15 March 1861. Disposal of battery same as Battery Ayers.
CONST. 218 (NC)	6"	2-1903AZ	BC	Range 27,500 yards.* Work started 22 October 1942. Emplacement of carriages completed 28 December 1943. Status January 1944 - Under construction (estimated date of completion October 1944).
MILLS (o)	6"	1-1897M1	DC	Named in honor of memory of Brevet Colonel Charles J. Mills who served with distinction in Civil War as Captain U.S. Volunteers and Assistant Adjutant General. Killed in action at Hatcher's Run near Petersburg, Va. 31 March 1865. Battery manned in 1941, 24 hours provisionally 15 Sept. 1941, placed in Class "C" 3 Nov. 1943. Disposal Authorized 9 Nov. 1943. Guns shipped to Watervliet Arsenal 28 Dec. 1943. Status January 1944 - Dismantled.
AMTB No. 19 (NC) (Nortons Pt.)	90mm	4-M1	(##)	Range 8000 yards. Guns received summer of 1943. Proof fired on or about 15 Sept. 1943. Assigned personnel by NYPPER-ONE 18 February 1943. Status January 1944 - Class "A" (two fixed guns).



F O R T H A M I L T O N N. Y.

No order naming Fort Hamilton appears to be on file. Without definite information, regarding which "the records of the War Department are singularly silent," there is little doubt that it is named in commemoration of the distinguished services of Alexander Hamilton, a member of the Cabinet of President Washington.

Ground was broken for the Fort on 26 April 1825. Captain George Beaney, Corps of Engineers, was the supervising engineer while his assistant, Lieutenant Mansfield, was in immediate charge. The cornerstone of the old works was laid 11 June 1825.

The garrison for the Fort was established on 1 November 1831 by Battery "A", Fourth Artillery, under Captain Levi Whiting and consisted of two officers and 52 enlisted men from Fort Columbus. From that time until April 1847 Fort Hamilton appears to have been a sub-post of Fort Columbus or under the command of the senior officer in New York Harbor. Its status as a separate independent command dates from 22 April 1847. (From Fort Record Book, Fort Hamilton)

BATTERIES

<u>Name</u>	<u>Cal.</u>	<u>No. and Mod.</u>	<u>Car.</u>	<u>Notes</u>
DOUBLEDAY (c)	12"	2-1883M1 $\frac{1}{2}$	DC	Named in honor of the memory of Major General Abner Doubleday, U.S. Volunteers a native of New York who served with distinction in the War with Mexico and the Civil War. The battery was placed in Class "B" 18 May 1942, turned over to ordnance by 18 Feb. 1943. Disposal authorized 9 Nov. 1943. Status Jan. 1944 - To be dismantled.
BROWN (c)	12"	1-1883M1 $\frac{1}{2}$ 1-1883M2	DC	Named in honor or memory of Brevet Major General Harvey Brown (Colonel 5th U.S. Artillery) who served with distinction during Mexican and Civil Wars. Died 31 March 1874. The battery was placed in Class "B" 18 May 1942 and turned over to ordnance by 18 Feb. 1943. Disposal authorized 9 Nov. 1943. Status Jan. 1944 - To be dismantled.

WADSWORTH BATTERIES  
(Cont'd)

<u>Name</u>	<u>Cal.</u>	<u>No. &amp; Mod.</u>	<u>Car.</u>	<u>Notes</u>
AMTB No. 11 (NO) (Miller Field)	90mm	4-M1	(#)	Range 8000 yards. Two guns in place 30 April 1943. All four guns emplaced and manned by July 7, 1943. Assigned personnel by HYPNER-ONE 18 Feb. 1943. Status Jan. 1944 - Class "A" (Two fixed guns). To be retained.*
AMTB No. 12 (NO) (Swinburne Is.)	90mm	2-M1	T-3	Range 8000 yards. Battery of two fixed guns emplaced and manned by 28 Aug. 1943. Status Jan. 1944 - Class "A". #
CATLIN (s) (New Catlin) (Btry. No. 20)	3"	6-1902	RF	Named in honor of memory of Captain Robert Catlin, Fifth Artillery, who served with distinction in the Civil War and died 28 Dec. 1903 at Washington, D.C. Battery range 11,000 yards.* Two guns manned in December 1941 because of lack of personnel. Relocated with two guns in new emplacement at Rockaway Point (Btry. No. 20) by 14 April 1942. Four guns to make NEW CATLIN relocated at Norton's Point (Sea Gate) L.I.N.Y. by Dec. 1942. Status Jan. 1944 - Class "C".# To be retained.*
TURNBULL (s)	3"	6-1903	RE	Named in honor of memory of Major William Turnbull of Topographical Engineers and Corps of Engineers who died 9 Dec. 1857. Battery range 11,000 yards.* Manned Dec. 1941. Relocated by 31 October 1942, four guns at new location at Fort Wadsworth and two guns shipped to help form new RF battery at Fort Miles (Btry. No. 5). Status Jan. 1944 - Class "C".# To be retained.*
AA No. 3	3"	2-1917A2 1-1917M1A2	AA	Manned and Class "A" until 25 November 1943 when all 3-inch fixed AA Batteries changed from Class "A" to Class "C". Status Jan. 1944 - Class "C".#

HAMILTON BATTERIES  
(Cont'd)

<u>Name</u>	<u>Cal.</u>	<u>No. &amp; Mod.</u>	<u>Car.</u>	<u>Notes</u>
PIPER (n)	12"	4-1890M1	Mort.	Named in honor of memory of Colonel Alexander Piper, 5th U.S. Artillery, who served with distinction in the Civil War and perished in the Park Avenue Hotel fire, New York City, 22 Feb. 1902. The battery was unclassified in the armament report of 15 July 1939. Not listed "Status of Armament" report 1 July 1941. Status Jan. 1944 - Dismantled.
HEARY (n)		2-1888M2	BC	Battery name was transferred from btry. of the same name Fort Columbus, Btrys. guns ordered shipped to Watervliet Arsenal and carriages scrapped 7 Nov. 1940. Status Jan. 1944 - Dismantled.
GILMORE (n)	10"	2-1895 2-1888	DC	Named in honor of Major General Quincy A. Gilmore, U.S. Volunteers; Colonel, Corps of Engineers, U.S. Army, and served with distinction in the Civil War. Battery ordered transferred to ordnance for salvage 12 Nov. 1942. Status Jan. 1944 - Dismantled.
LIVINGSTON	6"	2-1900	BC	Named in honor of memory of Brevet Captain Manning Livingston, U.S. Army (Second Lieutenant 3rd U.S. Artillery), killed in action at Gettysburg 2 July 1863. Battery Class "A" armament in 1941. Manned on 24-hour basis June of 1941. Class "B" March 1943. Status Jan. 1944 - Class "C".# To be retained.* (Range 17,000 yards)
JOHNSTON (o)	6"	1-1897 1-1897M1	DC	Named in honor of memory of Captain Abraham R. Johnston, 1st U.S. Dragoons, killed in action at San Pasqual, Calif., 6 Dec. 1846. Battery listed ready for service in Armament Status Report 1 July 1941. Placed in Class "C" 18 May 1943. Disposal authorized 9 Nov. 1943. Status Jan. 1944 - Dismantled.

HAMILTON BATTERIES  
(Cont'd)

<u>Name</u>	<u>Cal.</u>	<u>NO. &amp; Mod.</u>	<u>Car.</u>	<u>Notes</u>
GRIFFEN (s)	3"	2-1905	BC	Named in honor of memoray of Colonel Charles Griffen, 35th U.S. Infantry, Brevet Major General, U.S. Army and Major General U.S. Volunteers. Served with distinction in Civil War and died 15 Sept. 1867 at Galveston, Texas. Battery's range 11,000 yards.* Manned in 1941. Placed in Class "B" 6 March 1943. Status Jan. 1944 - Class "C".# To be retained.*
AA No. 4	3"	3-1917M1A2	AA	Manned and Class "A" until Nov. 1943 when all 3-inch fixed AA batteries changed from Class "A" to Class "C". Status Jan. 1944 - Class "C".#

-000-

F O R T T O T T E N , N . Y .

BATTERIES

<u>Name</u>	<u>Cal.</u>	<u>No. &amp; Mod.</u>	<u>Car.</u>	<u>Notes</u>
BAKER	5"	2-1902M1	BC	Range 11,000 yards.* Serviceable but not manned Dec. 1941. Manned 17 April 1942, Class "A" armament. Status Jan. 1944 - Class "A"#. To be retained.*
BURNS	3"	2-1902M1	BC	Range 11,000 yards.* Manned Dec. 1941. Placed in Class "B" 23 July 1943. Status Jan. 1944 - Class "C".# To be retained.*
AA No. 6	3"	3-1917A2	AA	Manned and Class "A" until Nov. 1943 when all foxed 3-inch AA batteries changed from Class "A" to Class "C". Status Jan. 1944 - Class "C".#

GENERAL NOTES

155 mm batteries in the Harbor Defenses of New York were never granted authority for Panama Mounts and were never classified as semi-fixed or temporary batteries.

The Headquarters, 52nd CA (Ry), until its division into separate battalions, was at Fort Hancock and this armament was present in the Harbor Defense in varying amounts. One railway battery (S\*) remained as of January 1944 (Battery "A", 288th Sep Bn CA) with Class "A" status#.

Batteries 5 (Peck), 10 (Mines), 19 (90mm - Nortons Point), 25 (mines), and 26 (Baker) continue "present" assigned condition status (II). Remaining batteries assumed Condition III, effective 18 November 1943.

SECTION III

(Part 2)

---

PHILADELPHIA SUBSECTOR  
AND  
HARBOR DEFENSES OF THE DELAWARE

---

(HECP'S, FORTS AND ARMAMENT)

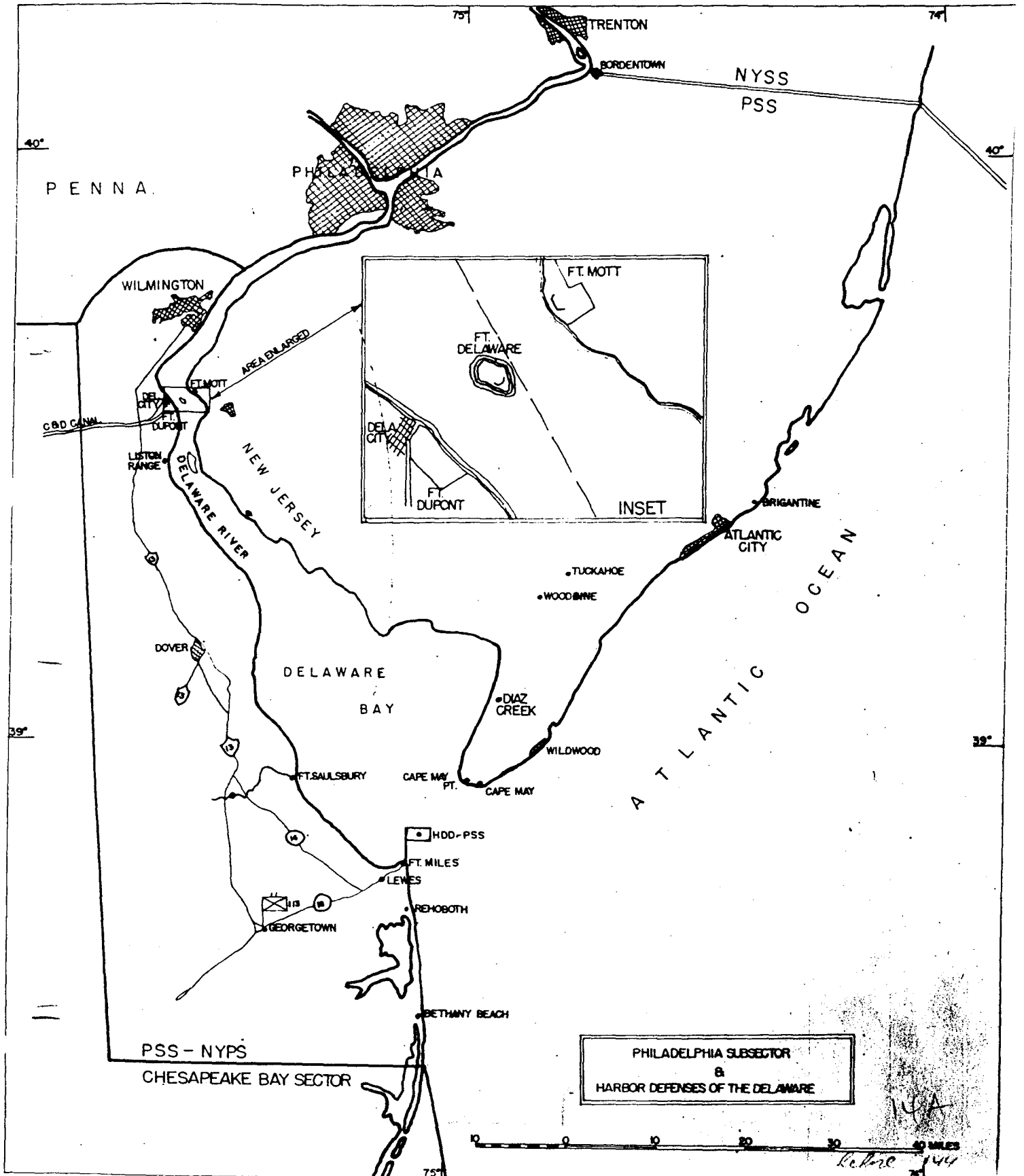

PENNA.

PHILADELPHIA

TRENTON

BORDENTOWN

NYSS  
PSS

WILMINGTON

CBQ CANAL

LISTON RANGE

NEW JERSEY  
DELAWARE RIVER

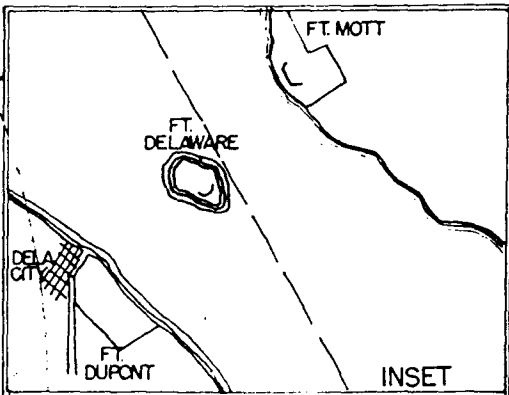

ATLANTIC CITY

ATLANTIC OCEAN

TUCKAHOE

WOODBINE

DELAWARE BAY

DIAZ CREEK

WILDWOOD

FT. SAULSBURY

CAPE MAY PT.

CAPE MAY

HDD-PSS

FT. MILES

LEWES

REHOBOTH

GEORGETOWN

BETHANY BEACH

PSS - NYSS  
CHESAPEAKE BAY SECTOR

0 10 20 30 40 MILES

14A  
K. Lane 1/44



The Philadelphia Subsector and the Harbor Defenses of the Delaware had a somewhat different problem to meet in modernizing defenses and guarding the section of coast assigned to them in the New York-Philadelphia Sector Plan.

It was true that the Harbor Defenses of the Delaware was present before 1941 were old and established fortifications (as were the Harbor Defenses of New York) before methods of modern warfare were devised but the plan of modernization eventually required the building of altogether new fortifications on the capes at the mouth of the Delaware Bay, Henlopen and May, while the defenses of New York Harbor required the sandwiching of new armament within the old.

In the Harbor Defenses of New York it was a case of moving in while workmen were remodeling the old house. In the case of the Harbor Defenses of the Delaware it was the situation of moving into a new house while it was under construction, with the furniture being carried piecemeal from the old and added to the new.

The old fortifications were those up the Delaware River some 70 miles from the Breakwater, Forts Dupont, Delaware, Mott and the somewhat younger Saulsbury. The new fortifications were to be Fort Miles on Cape Henlopen with supporting batteries on Cape May.

The deficiencies of the defenses of the Delaware River were recognized long before any move was made to strengthen them. In a letter of July 3, 1928 on the subject Brigadier General S. Heintzelman, then Commanding General of the Second Coast Artillery District, called attention to the ages of the armament of Forts DuPont, Delaware and Mott, and the isolation and faulty tactical location of Fort Saulsbury and remarked:

".... Projects under consideration contemplate placing the defenses at one or both of the Delaware Capes (May or Henlopen), which will no doubt be realized when funds become available and will, if practicable, include the use of Fort Saulsbury."

fixed armament for this defense was contemplated. This decision was reached on the basis of the fact that no permanent Naval base for capital ships was contemplated for the Delaware Bay. However it was realized that the water areas of the bay would major armament was necessary.

To meet the requirement it was proposed to use one battery of two 14-inch guns on railway mounts and a battery of two 8-inch (Navy) guns on railway mounts. It was felt at that time that this solution should prove both economical and satisfactory.

In addition the bay was to be provided to be with an underwater defense and the protection of the projected mine field was solved by one battery of 155mm guns at Cape Henlopen. It was felt that these guns could cover the mine field without "concrete platforms." To cover the Cape May side of the entrance it was felt that, due to the shallow water, one battery of 155mm guns would be sufficient to combat lighter armored naval targets of shallower draft and to aid in the defense of the mine field. For these guns "firing platforms should be provided though they need not be constructed until an emergency arises.

It was also assumed that the guns would support the defense against a landing attack on the coast within range of the weapons.

For the up-river defense the fields of fire were such that an enemy ship would come under fire, about 14,000 yards below the entrance to the Chesapeake and Delaware Canal. Capital ships following the channel would be enfiladed by fire from the 12-inch batteries at Forts Mott and Delaware. It was stated:

"If batteries Torbert and Arnold, each of three 12-inch guns, are retained they will be able to meet any capital ships or cruisers likely to participate in an attempt to force a passage of the river. Batteries Hentig and Elder, each of two 8-inch guns are also required for use against destroyers or other small boats. Batteries Best and Rodney, each of four 12-inch mortars, and Battery Harker, three 10-inch guns (disappearing carriage), can be eliminated."

All fixed armament listed in the project was to be maintained as Class B except Arnold and Torbert, the disappearing carriage batteries of 12-inch guns.

Fire control elements were to be a subject of further study with a contemplated plan to be put into operation only in case of an emergency.

A 60-inch, fixed searchlight at Fort Delaware was the illumination facilities.

The underwater defenses were to consist of 25 groups of controlled mines across the main channel entrance to the Delaware Bay and an anti-submarine net across the entrance to the Harbor of Refuge at Cape Henlopen.

For antisircraft defense, no antiaircraft artillery was present in the defense then, of harbor defense installations it was considered necessary in 1933 to have twelve 3-inch guns distributed as follows:

Three at Fort Mott, three at Fort DuPont, three at Fort Saulsbury, all fixed, and three mobile 3-inch guns at Cape Henlopen.

As we will see this project of 1933 is outlined above was to undergo considerable revision before actual work was begun on the projects.

Coming closer to the time in which we are interested, we find one of the earliest "organization of command" for Philadelphia Subsector and the Harbor Defenses of the Delaware, showing the elements of defense that were to be realized upon in the defense of the Delaware some months before the outbreak of actual warfare.

The sketch of the grouping of "our harbor defense armament as it actually exists at the present time", reproduced as Plate No. 15, was an inclosure in a letter sent by Captain Bernard E. Waterman, 21st Coast Artillery, to Major J.S. Mayer, Second Coast Artillery District, dated June 4, 1941.

This armament picture was evidently changed very little in the succeeding

A commentary on the personnel situation at the time the letter was written is to be found in this paragraph:

"All forts are on a caretaking status in charge of a detachment of one officer and twenty-nine enlisted men, which strength was fixed at a minimum for bare upkeep under normal conditions and is divided among the four forts as needs demand."\*

The "projects under consideration" cited by General Heintzelman were set down on paper in greater detail when the basic project for the Harbor Defenses of the Delaware was drawn up in 1933. At that time it was contemplated that the Harbor Defense would be a part of the Delaware Subsector under the Delaware-Chesapeake Sector of the North Atlantic Coastal Frontier.

HDD - (Ref. Harbor Defense Projects --- in the Philadelphia-Delaware Area (CCA-P-P Approved Secretary of War May 11, 1933)

When the project was initiated in 1933 there were only four long range guns in the Harbor Defense, the four 12" BC guns of batteries Hall and Haslet, with a range of 29,300 yards located at Fort Saulsbury. This was the only gun installation in the lower bay and its field of fire covered the deep water inside the capes Henlopen and May. The rest of the armament was that up river, concentration in the vicinity of Delaware City and the entrance to the Delaware and Chesapeake Canal.

The deficiency of seaward defense to deny enemy an entrance into Delaware Bay and permit the debouchment of our own naval vessels was recognized but no

---

**NOTE \*** That General Heintzelman's observation of 1928 was not isolated circumstance is indicated by an indorsement on a letter dated May 1, 1939 which Captain Paul A. Harris, 7th CA, Commanding the Harbor Defenses of the Delaware then wrote:

"The only CAC troops in the HDD are those of Battery E, 7th CA, consisting of two officers and about 50 men. From these are furnished caretaker detachments at Fort DuPont of about 28 men, Fort Delaware 6 men, Fort Mott 6 men and Fort Saulsbury 6 men. All armament is in commission but out of service."

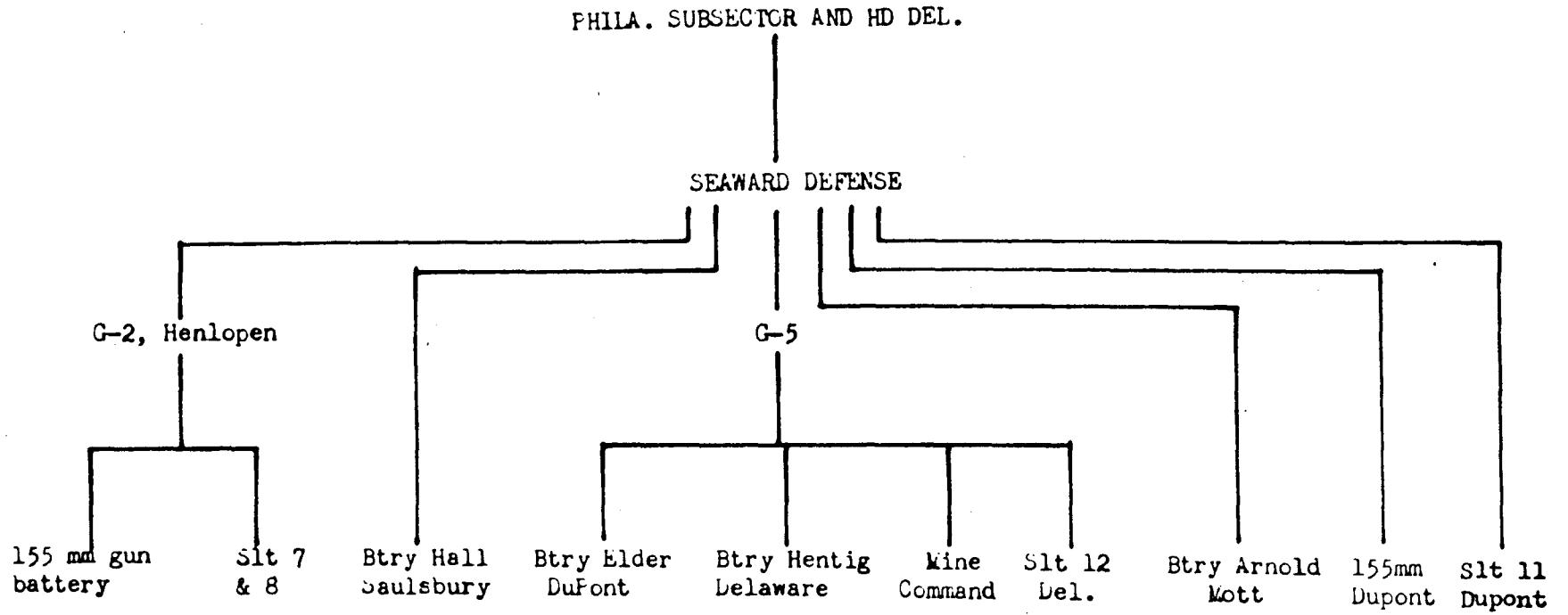

months before December, 1941 as an overlay map of the elements of Armament for the Harbor Defenses of the Delaware, dated January 19, 1942 shows that the armament was in three groups, geographically, in separated locations from Fort Delaware, up river, to Cape Henlopen (Fort Miles) on the coast.

At Ft. Delaware, on Sea Patch Island in the Delaware River was Battery No. 8, Bentig, two 3-inch rapid fire guns. A short distance south on the Delaware Shore at Delaware City was Ft. DuPont with Battery No. 7, Elder, another pair of 3-inch rapid fire guns while on the New Jersey Shore at Ft. Mott was Battery NO. 9, Arnold, three 12-inch disappearing carriage guns. This group covered about 25000 yards of river with supporting fire. The 3-inch guns had a range of about 9000 yards while the 12" range was 17,300 yards.

Further south, near the mouth of the bay, was battery No. 6, Hall, guns with a range of 29,300 yards, "temporarily" located at Fort Saulsbury. The extreme range of gunfire to the south covered the entrance to the Delaware Bay from Cape Henlopen to short of Cape May Point.

The outer groupment was on Cape Henlopen and Cape May, consisted of three batteries of four 155mm guns. They covered the sea approaches to the bay 17,000 yards out. The one battery on Cape May, Battery No. 5, was on Panama Mounts while Fort Miles on Henlopen had one battery on while Panama Mounts Battery No. 2, the other battery, No. 3 was not so mounted.

Proposed at that time, to bulwark that limited fire power seaward was Batteries Nos. 1 and 4, each two 6-inch BC guns with range of 26,000 yards and batteries Nos. 2 and 3, each two 16-inch guns with a range of 44,690 yards, all on Cape Henlopen, Ft. Miles. Cape May was to get a battery, Nos. 5, of two 6-inch BC guns, 26,000 yards, to cover its side of the water.

On December 7 at 5:45 o'clock in the afternoon, Brigadier General Arthur G. Campbell, Commanding General of the Second Coast Artillery District, sent out a teletype message to the Commanding Officer, Harbor Defenses of the Delaware, then at Fort DuPont, of just three words:

"Condition Two Immediately" (Ref. 470/36)

This threw the works into gear to operate on a war basis. The building of the Harbor Defenses of the Delaware was to begin in earnest.

Among the first moves by the Commanding Officer of the Harbor Defenses of the Delaware after the Seventh of December was to declare the establishment of Fort Saulsbury and Miles. This was confirmed by General Orders No. 23, Harbor Defenses of the Delaware, dated 20 December 1941 which read in part:

Verbal orders of the Commanding Officer establishing Fort Miles, Delaware and Fort Saulsbury, Delaware as forts ..... are hereby confirmed and made of record. Forts Mott and Delaware will continue to be administrated as sub-posts of Fort DuPont."

The personnel of the Harbor Defenses had changed drastically since General Heintzelman's "one officer and twenty-nine enlisted men," as the Nation prepared to meet the emergency that was see approaching.

A battalion of infantry, the 2nd Battalion, 113th Infantry Combat Team, was thrown into the breach and Coast Artillery troops had been mustered until the Sector Station List for Philadelphia Subsector, dated 3 February, 1942, looked like this:

HARBOR DEFENSES OF THE DELAWARE - Fort DuPont, Del.

Hq and Hq Btry., HD of the Delaware  
Det. Hq & Hq Btry; Btry C (less Det.) 261st  
Dets. Hq & Hq Btrys A, B, & C; Det. of  
Med. Det; 21st CA.

Fort Miles, Del.

Det. Hq & Hq Btry, Det of Att. Med., 21st  
Btry A (less Det, B (less Det.), 21st CA

Hq. and Hq. Btry (less Det), Det. of Att. Med.  
Btry A, 261st CA.  
Improvised AMP Colonel Henry R. Casey

Fort Delaware, Del.

Det. Hq and Hq Btry., 21st CA  
Det. Btry C, 261st CA

Fort Mott, N.J.

Det. Hq & Hq. Btry. 21st CA

Fort Saulsbury, Del.

Det. Hq & Hq Btry., 21st CA  
Det. Hq & Hq Btry; Det. Att. Med Det. Btry B  
261st CA

Cape May, N.J.

Det. Hq & Hq Btry; Btry C (less Det); Det. of  
Att. Med. Det.; 21st CA

Co. F, 113th Inf.  
Det. Co. H, 113th Inf.  
Det. Co. F, 104th Eng.  
Det. Co. A, 119th Med. Regt. (Col.)  
Det. Co. E, 119th Med. Regt. (Amb)  
Det. Co. A, 119th QM Regt. (Trk.)

ATTACHED COMBAT TEAM

Georgetown, Del.

Det. Hq & Hq Btry., 21st CA  
Det. Hq. & Hq Co., 113th Inf.  
Det. Service Co., 113 Inf.  
Plat. Anti-tank Co., 113th Inf.  
2nd Bn. 113th Inf. (less Co. F & Det. Co. H)  
Btry C, 165th FA  
Co. F, 104th Eng. (less Det.)  
Det. Co. A, 119th Med. Reg. (Col.)  
Det. Co. E, 119th Med. Regt. (Amb.)  
Det. Co. A, 119th QM Regt. (Trk.)

The conditions of the troops sent to the Capes to fulfill the missions demanded by the outbreak of War, prematurely as far as preparation of facilities is are concerned, is described briefly in a S-4 report of housing dating 20 December 1941.

In this report it is stated that Battery "C", 21st CA (HD) with 4-155mm guns, is sited on property belonging to the University of Pennsylvania at Cape May Point.



The troops were temporarily occupying St. Mary's Convent nearby.

The Harbor Defense troops at Fort Miles, Del., were in winterized tents pending completion of semi-permanent barracks. In this connection it is noted from other sources that the first contentment construction was started at Fort Miles in November 1941.

The Battalion Combat Team for Subsector had its headquarters in an old CCC Camp near Georgetown.

Battery "C" of the then 165th FA, were in the old buildings while the troops of the 2nd Bn., 113th Infantry, less Co. F and detachments, were in pyramidal tents.

At Cape May Co. F, 113th Infantry, and detachments of the Machine Gun Company and Anti-tank Company were quartered in buildings owned by Lower Township, Cape May County.

The command of the Harbor Defenses of the Delaware rested at Fort DuPont with the Harbor Defenses Hq. and Hq. Battery there. The other posts, Cape May, N.J., Fort Miles, Del., Fort Saulsbury, Del., Fort Delaware, Del. and Fort Mott, N.J. were sub posts of Fort DuPont. Fort Delaware and Fort Mott were in the hands of care-taking detachments only. This was as of Station Lists of January 15, 1942.

According to the Station List of the Second Corps Area for January other troops not assigned to the Eastern Theater of Operations Command present at Fort DuPont included:

Delaware Military District, CASC Unit 1250 and Station Complement, CASC Unit 1231, both assigned to the Corps Area; Ma. Co., II Army Corps; 70th Engineer Company (LP), attached to II Army Corps; 1st Chemical Co. (Decon) (Cld), assigned to First Army.

The movement of armament for the HDD to the mouth of the Delaware Bay was initiated with an order from the Headquarters of the Second Coast Artillery District

directing Col. George Ruhlen as Commanding Officer of the HDD at DuPont to install at Cape Henlopen a battery of four 155mm guns with accessories, improvised fire control, personnel, field communications and improvised facilities for the storage of 200 rounds of ammunition. The site was to be in the general area to the north of the main road and to the west of the road leading to the Navla Radio Compass Station. This was April 15, 1941. (Ref. 381/15NET)

One gun was to be maintained "in a state of instant readiness against targets entering Delaware Bay." Should any vessel commit anyact, which, in your judgement threatens the security of the Delaware Bay or its approaches you are directed to use whatever force is necessary to defeat such action ...." The command was to cooperate with the Inshore Patrol, Fourth Naval District.

After the installation of the battery the command was further ordered to transfer to Cape Henlopen the observation and surveillance post activated pursuant to the provisions of GO No. 4, this headquarters, March 27, 1941. This was to be the Harbor Entrance Control Post, the plans for which were then only in the minutes of the Local Joint Army and Navy Planning Committee.

In compliance Battery "C", 261st and Det. Hq Btry. 261st CA left Fort DuPont, Del. under the command of Major Ralph S. Baker on April 16 and arrived at Cape Henlopen the same day. The four 155mm guns, two portable HD Searchlights, a tractor and such accessories and fire control equipment as was available were shipped by freight and arrived at Lewes, Del., Sunday, April 20.

The action directed was completed about the first of June and in accordance with verbal instructions, HDD had moved Btry. "B", 261st and four more guns down to Cape Henlopen on June 5, 1941 (Ref. 381/16/31/NET)

The movement of men and guns to Fort Saulsbury, Del. and Cape May, N.J. was ordered by the Harbor Defenses of Delaware in General Orders No. 8, dated June 27, 1941.

Battery C, 21st CA was ordered to move to Fort Saulsbury on Saturday, June 28, 1941 accompanied by one medical officer and two enlisted men of the Medical Detachment, 21st CA.

Battery B, 261st CA was ordered to move to Cape May on Monday, 30 June 1941 with a battery of four 155mm guns towed by truck. One tractor was sent down on Sunday, 29 June 1941 and the Ordnance Officer shipped 200 rounds of 155mm Ammunition to Cape May. (Ref. 370.05/6)

It is apparent that in the days of the "State of Readiness" order troop units were shifted by Harbor Defense command to meet an ever altering situation. It is safe to assume however, that the Sector Station list of February 8, 1942, a re-produced on pages , represents the situation at the opening of 1942, the war year.

The difficulty of meeting the requirements of coastal defense from a headquarters 80 miles from the coast (more than a 100 miles by rail) by highway and manning defenses located at no less than six different places, presented a problem that was eventually to be solved by the gradual concentration of armament and personnel on the Delaware Capes and the eventual shifting of the command post for Philadelphia Subsector and the Harbor Defenses of the Delaware to the center of the scene of operations, Ft. Miles, Del., on Cape Henlopen.

In addition to the deployment of Harbor Defense troops, the Infantry Combat Team was on the move at the turn of the year.

The Combat Team for the Subsector was moved into the area by Special Orders

No. 295, Hq 44th Division, Fort Dix, N.J., dated 19 December 1941, in which the 2nd Bn., 113th Infantry (Mtzd) with the 2nd Bn. Communications Section and 2nd Bn. Medical Section, 113th Infantry; Battery C, 156th Field Artillery; Company A, 104th Engineers; 2nd Platoon, Company A, 119th Quartermaster Regiment with two addition trucks and drivers and one ambulance, 119th Medical Regiment attached were order to "proceed without delay" to concealed bivouac in the vicinity of Georgetown, Del. Supplies were to be furnished by the quartermaster at Fort DuPont, Del.

The movement is described in a report signed by H. Norman Schwarzkopf, Colonel, 113th Infantry, Commanding, dated 17 February 1942, as follows:

"The 2nd Battalion left Fort Dix, N.J., December 15, 1941 and arrived Georgetown, Delaware December 16, 1941, less Company F, detached enroute, which arrived at Cape May Naval Station, December 16, 1941.

"Company F left Cape May Naval Station and arrived Cold Springs, N.J., December 18, 1941.

"Company F left Cold Springs, N.J., and arrived at Woodbine, N.J. February 10, 1942." (Ref. 370.5/83)

This may be said to complete the first or emergency phase of preparation to meet any attack on the Subsector. In addition to the fixed armament in the river forts two 155mm gun batteries were on Cape Henlopen, one 155mm gun battery was on Cape May; field artillery and troops were at Georgetown with a supplementary Combat Team force at Woodbine, N.J. The mine project was underway at the entrance of the Delaware Bay as an additional activity.

The Mine Command for the Harbor Defenses of the Delaware was initiated on 5 January 1942 by General Orders No. 3, same headquarters and same date.

as "activated" the command consisted of Batteries A and B of the 21st CA and was under command of the Commanding Officer of the 1st Battalion, 21st CA. A Medical Detachment, 1st Battalion 21st CA, Medical Section, was attached to the

Mine Command. In this connection General Orders No. 2, Hq., Harbor Defense of the Delaware, dated January 2, 1942, relieved Battery A, 21st CA, from assignment to Battery Elder and Battery Hentig, Ports DuPont and Delaware, and Battery C, 261st CA, was assigned to Batteries Elder and Hentig.

This underwater defense for the Delaware Bay evolved into a project for 35 groups of M4 (ground type) mines planted in three lines across the deep water channel off Cape Henlopen. These mines covered a front of some 8000 yards extending roughly northeast from Cape Henlopen, the right flank resting against Hen and Chicken Shoal. The project was approved 17 January 1943 by War Department Endorsement on AGO letter, subject: "Revision of Underwater Defense Projects," dated 20 October 1942.

In addition to the mines the mine command operated and maintained three hydrphone sets in front of the mine field. These underwater sound detection devices were augmented by a Navy installation of two underwater detector loops, a magnetic device, across the outer approaches to the channel entrance to Delaware Bay. These three devices, mines, 'phones and loops acted as the underwater "watch dogs" of the Delaware Bay, the mines having an addition function of detection when not set to fire.

To install and maintain this equipment the Mine Command was to have eventually a "fleet" consisting of the U.S. Army Mine Planters "Sylvester" and "Frank", the emergency mine planter "Casey", a converted river freighter, four "L" boatw, the 71, 72, 77 and 109 and twelve yawls. (Ref. Supplement to HDD Project 44)

Other moves made in the early part of 1942 to bolster the defenses of the Delaware included the erection of Panama Mounts to widen the fields of fire of the 155mm batteries at Capes Henlopen and May and provide a rapid fire battery for

the purpose of anti-Motor Torpedo Boat (AMTB) defense.

The proposal to mount the 155mm batteries on Panama mount was originally made June 25, 1941, a request that was approved by the War Department in August at the same time similar requests for mounts at Forts Hancock, Tilden and Wadsworth in New York Subsector were turned down. (Ref. 660.2/16) However it was not until January 5, 1942 that the mounts at Fort Miles were proof fired (Ref. 660.2/28) and February 9, 1942 that the Engineers wished to turn the installations at both Cape May and Ft. Miles over to troops who "had already occupied them." (Ref. 660.2/27)

It is interesting to note at this point the other installations included in the U.S. Engineers Office letter of FEB. 9, 1942 as ready to be "transferred to the Harbor Defense Commander for use and care by troops." (Ref. 660.2/27)

At Fort Miles, Delaware:

Mine warf, mine boathouse, two mine loading rooms, mine storehouse, two small magazines, four T.M.T igloo magazines, four cable huts, mine casemate, cable tank building, cable testing tank, one searchlight shelter building, temporary Harbor Entrance Control Post, four fire control towers, Nos. 3-2, 4, 5, and 7.

At Fort Saulsbury, Delaware:

Five fire control towers, Nos. 9, 10, 12, 13 and 14, one searchlight shelter, four cable huts.

However these installations were still not turned over to the Harbor Defenses in February 1944.

The problem of AMTB defense here was quite different than that for New York Harbor. In the first place the width of the mouth of the Delaware Bay made the detection of skulking torpedo boats in darkness or fog an improbability and coverage by gun fire a remote possibility. In the second place no target, in the immediate vicinity of the entrance to the bay, existed for torpedo boat attack. However

plans were made for rapid fire gunfire to protect anchorages and channels from such speedy naval assaults and to protect the mine field.

At a meeting of the Local Joint Committee for Philadelphia Subsector and the Fourth Naval District on April 14, 1942 and site was named for a battery of four 3-inch rapid fire guns to protect anchorages and moorings at "Station No. 5" near the tip of Cape Henlopen, a site that would also permit the coverage of the controlled mine field. This battery was later to be known as Battery No. 3 at Fort Miles.

To make up this 3-inch battery the two guns of Battery Hentig at Fort Delaware and two guns of the 6-inch Battery Turnbull at Fort Adsworth, Staten Island, N.Y. were moved to Fort Miles. Turnbull's guns were shipped to Fort Miles on May 23, 1942 with sights, pedestals and shields, and Battery Hentig was moved to Fort Miles June 7, 1942. The new 4-gun battery thus created was reported in order and capable of going into action at its new site at Fort Miles September 11, 1942.

Another AMTB defense problem that involved the resiting of a 3-inch battery in the Harbor Defenses of the Delaware, was created when the Navy installed an AMTB boom in the Delaware River at Reedy Island "on or about March 16, 1942." At this point in the river the Navy determined that the channel was narrow enough to warrant the siting of such an obstruction and had requested the coverage of artillery, with a 60-inch searchlight, for the boom.

This raised a new question in harbor defense responsibility since the coverage of AMTB obstruction such as this boom (and anti-sub net) had been omitted from harbor defense projects. However the Local Joint Planning Committee worked out a plan and a policy for such a boom. The result was that Battery Elder, Fort DuPont, was removed to its new location on the "Liston Front Range" (Bayview, Del.) a

a Coast Guard Reservation by March 10, 1942. (Ref. 660.5/232)

This called for a change in station and reassignment of armament for Battery "C", 261st CA. This was accomplished by General Order No. 9 Philadelphia Subsector, dated May 22, 1942 which read:

Battery "C", 261st CA relieved from assignment Battery Elder, Battery Hentig, SLT No. 11, Fort DuPont, and SLT No. 12, and is assigned to Battery No. 3, Fort Miles, Battery No. 7, Bayview, Del. and SLT No. 11, Bayview, Del.

The order also relieved Battery "C", 261st CA from station at DuPont, Del., and assigned it to Fort Miles, Del., with a detachment stationed at Bayview, Del.

This Bayview Battery had a short life and we will depart from chronological order to record its demise. The Navy reconsidered its plan of AMTB defense on the basis of the distance of the obstruction from the mouth of the Delaware Bay, arguing that a torpedo boat attack would be directed at targets more available from the sea and would not attempt a long run up the Delaware River. The result was that the Navy reported to the Army the dismantling of the boom and net at Reedy Island 4 December 1942. Subsequently EDC directed the removal of the artillery. (Ref. 660.3/245)

The Bayview guns were reported out of action by the Harbor Defense on February 6, 1943 and being dismantled. The personnel, the detachment of Battery "C", 261st CA, was placed in a 90mm battery at Fort Miles on March 15, 1943. The armament was removed to local ordnance storage at Fort Saulsbury by March 10, 1943.

While all this attention was being paid to defenses that required rapid fire the problems of meeting an attack that called for heavy armament was not being neglected. At the same time the modernization program that had been described in the section dealing with Sector planning (Section II, Part 1) was being pushed by Engineers. Emplacements and fire control installations were springing up on Delaware and New Jersey sides of the bay for 16-inch batteries, 6-inch batteries



and one 12-inch battery which was a new location for the guns of Battery Haslett, replacing a projected 16-inch battery construction at Fort Miles.

But Fort Miles needed heavier armament to supplement its 3-inch and 155mm guns sooner than Engineers could accomplish the construction of new batteries in face of priority demands. This was a critical need since Fort Miles had no older armament, as the Harbor Defenses of New York had, to fill in the gap during the transition period. The answer was the 9-inch railway guns of the 52nd CA which had its headquarters at Fort Hancock, N.J.

The first battery of the 9-inch railway guns to appear on the scene was Btry. "C" of the 2nd Battalion, 52nd CA that was dispatched and arrived at the scene of its new emplacements on Cape Henlopen March 15, 1942.

On March 21, 1942, Colonel Joseph C. Haw, Commanding Officer, 52nd CA (Ry), inspected the installations of Btry. "C" at Fort Miles. A picture of conditions at the new Fort is given in the report. We quote in part:

"Excellent work was done by the local authorities in grading and laying track in a hurry. The battery (Btry. "C") furnished a large detail for this work also. The Battery Commander, Captain Louis K. Levin, and his officers and men worked like Trojans and deserve commendation for the speed and thoroughness for which they got everything in readiness to fire. The Subsector Commander, Col. Ruhlén, and the Post Commander, Lt. Col. Roscoe, have done all they could for the battery.

"The base end stations which the local authorities have made available to the battery afford satisfactory range finding facilities.

"I strongly recommend that showers and latrines with running water be built at once for "C" Battery and that the government furnish good materials for duckboard walks in the tent camp. The makeshift latrines, showers and duckboards are a credit to the energy of the troops at Fort Miles but are totally inadequate. In fact the duckboards which the garrison had to build of scavenged material are breaking up and are liable to cause broken legs and other injuries."

"I strongly recommend that barracks, mess hall, day room, etc., be built for Battery "C" as soon as practicable, as the battery will no doubt spend the winter there and it takes a long time to get these projects completed. I understand the project for Fort Miles calls for additional buildings which would be adequate to

house the battery, and I urge that steps be taken at once to initiate the work."

Battery "C" was in position April 25, 1942 armament status reports state.

The rest of the 2nd Battalion, 52nd CA (Ry), under the command of Lt. Colonel Thomas S. McConnell, Headquarters and Headquarters Battery, and Battery "D", another gun battery, did not arrive at Fort Miles until September 10, 1942 from Fort Hancock, according to a teletype message from Colonel Raw to the Hq., Eastern Defense Command on that date. All four guns of Battery "D" were emplaced and oriented by 9 November according to ~~Armament~~ status reports.

The battalion of railway guns was still at Fort Miles in 1 January 1944 although it had been redesignated 287th CA (Sep) Bn (Ry) as the 2nd Battalion of the former 52nd CA (Ry) was known after the redesignation of that regiment April 22, 1943. Units of that regiment April 22, 1943. (See section II Part 3 "Troops of Sector" 52nd CA)

On the heels of all this shifting around of armament in the early months of 1942 Philadelphia Subsector and the Harbor Defenses of the Delaware was placed under a new Commanding Officer when Colonel Robert T. Phillips assumed command at Fort Dupont, Delaware under General Orders No. 8 of that headquarters, dated April 21, 1942. He succeeded Colonel George Kahlen who relinquished command April 15, 1942. The interim commander was Lt. Col. Roscoe, Jr., who was Post Commander, as published in General orders No. 7, also that headquarters, dated April 15, 1942.

Colonel Phillips was relieved from duty with the 11th CA, Harbor Defenses of Long Island Sound, Fort M.G. Wright, N.Y., by Special Orders No. 104, First Corps Area, dated April 18, 1942, for assignment to the Harbor Defenses of the Delaware, reporting to the headquarters of the Eastern Defense Command and First Army for

temporary duty before assuming command of the Harbor Defenses of the Delaware and Philadelphia Subsector.

With the rapid concentration of Armament at the mouth of the Delaware Bay and the resulting growing importance of Fort Miles with a relative shrinkage of the tactical importance of the up-river forts, other changes were in the making for the Philadelphia Subsector and Harbor Defense Command as Colonel Phillips took over.

Colonel Ruhlen on April 13, 1942 had asked New York-Philadelphia Sector that action be taken to designate Fort Miles, Del., as a separate Post. Fort Miles was then a sub-post of Fort DuPont, headquarters of Subsector and Harbor Defense, and some eighty miles away. Colonel Ruhlen in his request cited the difficulties of supplying and maintaining a sub-post of the size of which Fort Miles had grown at that time. As the Colonel wrote:

"This post (Fort Miles) houses over 800 troops, and upon completion of projected armament the garrison will number about 1100." (Ref. 323.7/83 Gen. & Miles)

The growing importance of Fort Miles also led General Haines, then Commanding General, New York-Philadelphia Sector to urge the relocation of the headquarters of the Harbor Defenses of the Delaware and Philadelphia Subsector at Fort Miles as "necessary for the maximum efficiency of command" in a letter of June 8, 1942.

Things were moving fast in this period however for while General Haines was urging the end of remote control for Subsector and Harbor Defense an Armament Status report of June 7, 1942 informs us that the Command Post of Philadelphia Subsector "is now in operation at Fort Miles and the Command Post, Harbor Defenses of the Delaware is located with the Command Post-PSS." The report also states that the Signal Station at Fort DuPont is closed down.

However these headquarters were not officially moved to the Cape "on a temporary basis" from Fort DuPont until noon of June 10, 1942 by General Orders No. 4, that date, Headquarters Philadelphia Subsector and Harbor Defenses of the Delaware, on verbal authority granted by the Commanding General, New York-Philadelphia Subsector. With these headquarters was also moved the Headquarters and Headquarters Battery of the 21st Coast Artillery.

This change was announced as a permanent change of station in a subsequent General Order, No. 7, dated July 25, 1942, Hq. PSS and HDD authority of a War Department letter - AG 370.5 (6-5-42) MS-E-M) - Subject, "change of Station", dated July 13, 1942 and Hq. NYPS indorsement, dated July 23, 1942, on letter from EDC and FA, same subject, dated July 19, 1942.

Fort Miles was designated as a "separate temporary post" by the War Department on October 2, 1942. (Ref. 323.7/83 Gen)

A Sector list of June 10, 1942 gives the best picture of the distribution of Subsector forces during this period of adjustment and revision. It lists:

PHILADELPHIA SUBSECTOR

Harbor Defenses of the Delaware

Hq. and Hq. Battery, Hd of the Delaware	Ft. Miles, Del.
Band, HD of the Delaware	Ft. DuPont, Del.
21st CA (HD) (less Btry C and Dets Hq and Hq Btry and Med Det)	Ft. Miles, Del.
Battery C, & Dets Hq & Hq Btry & Med Det, 21st CA(HD)	Cape May, N.J.
Det Hq and Hq Btry, 21st CA (HD)	Ft. Mott
Det Hq and Hq Btry, 21st CA (HD)	Ft. Saulsbury, Del.
Det Hq and Hq Btry, 21st CA (HD)	Ft. Delaware, Del.
261st CA (HD) Sep Bn (less Btry B and Dets Btry C, Hq Btry and Med Det)	Ft. Miles, Del.
Btry B and Det Hq Btry and Med Det, 261st CA Sep Bn (HD)	Ft. Saulsbury, Del.
Det Hq Btry, 261st CA Sep Bn (HD)	Ft. DuPont, Del.
Det Btry C, 261st CA Sep Bn (HD)	Bayview, Del.
Btry C, 52nd CA (Ry)	Ft. Miles, Del.
USAMP Col. Henry R. Casey (Improvised)	Ft. Miles, Del.

2nd Bn. 113th Inf. Combat Team

2nd Bn 113th Inf. (less Co F and Det Co H)	Georgetown, Del.
Co F and Det Co H, 113th Inf.	Belleplain, N.J.
2nd Plat, Antitank Co, 113th Inf	Georgetown, Del.
Btry C, 119th FA Bn	Georgetown, Del.
Det Hq Co, 113th Inf.	Georgetown, Del.
Det Service Co, 113th Inf.	Georgetown, Del.
Det Med Det, 113th Inf.	Georgetown, Del.
Co. G 22nd QM Regt (Trk) (less one section)	Georgetown, Del.
Co. C, 175th Engrs (GS) (less Dets)	Georgetown, Del.
Det Co C, 175th Engrs (GS)	Belleplain, N.J.
Det Service Co, 113th Inf.	Belleplain, N.J.
Det Med Det, 113th Inf	Belleplain, N.J.
Det 671st Collecting Co (Sep)	Belleplain, N.J.

It can be seen that personnel must have been spread thinly in spot to cover the command for the period represented by this list.

Shortly after this station list was published the Band of the Harbor Defenses of the Delaware was moved from Fort DuPont, Del., to Fort Miles, Del., leaving and arriving the same day, 15 July 1942.

An idea of the armament of approximately the same period can be gleaned from a tabulation of battery numbers listed for the Harbor Defenses of the Delaware and dated 1 July 1942. It follows:

PERMANENT BATTERIES

No.	Existing	Name	Type	Location	Const. No.
1	No	Herring	2-6" BC	#4-Fort Miles	221
2	No	Smith	2-16" BC	#4- "	118
3	No	-----	2-16" BC	#4- "	119
4	No	Hunter	2-6" BC	#42- "	222
5	Yes	-----	4-3" 15 PDR	#5- "	---
6	Yes	Hall	2-12" BC	#11-Ft. Saulsbury	---
7	Yes	-----	2-3" 15PDR	List on Front Range	---
8	Yes	Arnold	2-12" DC	#17 Fort Mott	66-
9	No	-----	2-6"	#20 Cape May	223

TEMPORARY BATTERIES

Temp No.					
21	Yes	-----	4-8" Ry	#4-Fort Miles	---
22	Yes	-----	4-155mm		
			Panama Mts.	#42- "	---
23	yes	-----	4-155mm		
			Panama Mts.	#20- Cape May	---

The designations Battery Herring and Battery Hunter appear on this list for the first time. These projected six-inch batteries at Fort Miles, Del., Construction No. 221 (6" South) and Construction No. 222 (6" North) were named in honor of deceased officer of the Coast Artillery Corps in accordance with War Department letter dated May 30, 1942. According to Subsector and Harbor Defense General Orders No. 5, dated June 11, 1942, Construction No. 221 was designated as Battery Herring in honor of the late Lieutenant Colonel Ralph E. Herring, CAC, U.S. Army, and Construction No 222 was designated as Battery Hunter in honor of the late Colonel Charles H. Hunter, CAC, U.S. Army.

As the physical appearance of Philadelphia Subsector and the Harbor Defenses of the Delaware changed so did the organization of command. All of the familiar names of pre-war years had disappeared when we came to the reorganization of Philadelphia Subsector and the Harbor Defenses of the Delaware for command purposes as outlined in General Orders No. 12, dated 18 Sept. 1942, that headquarters. The command lines were drawn in a sketch chart which is reproduced below: (Ref. 320/63)

This was a radical departure from the starting point of the organization as sketched slightly more than a year before, in June 1941. Gone were the old familiar names of batteries at Forts DuPont, Delaware and Mett. Fort Saulsbury was still in the tactical picture as a separate battery and the "Bayview" battery had been added to the river defense, "Henlopen" had become Miles and the additional functions of the Infantry Combat Team, the "Warning Center" and the liaison elements of Harbor Entrance Control Post and 4th Naval District Joint Operations Office had been tied into the picture.

A change in the assignment of patrols was made at the same time this re-organization was going into effect on the verbal authority of the then S-3 of the New York-Philadelphia Sector. It was the removal of all patrols of the 2nd Battalion, 113th Infantry Combat Team, from the beaches north of Fort Miles on the Delaware shore of the Delaware Bay. The withdrawal was made 17 September 1942 and personnel quartered on Breadkill Beach was removed to the vicinity of Georgetown. The installation at Breadkill Beach was dismantled and removed by Fort Miles Personnel.

The elimination of this patrol was an early move to effect economies of Combat Team Personnel in view of the manpower pinch that was always felt in Sector operations. The personnel removed was assigned interior guard duty at the CCC Camp near Georgetown and at Bethany Beach to relieve personnel of the 199th Field Artillery for training which had been neglected due to the necessity of filling in as guards.

To complete the picture of the Harbor Defenses of the Delaware we find a month later, 30 October 1942 a list of locations of the batteries in the Harbor Defenses, as of that date, as follows: (Ref. 660.2/46)

30 Oct 1942

Location No.	FORT	BTRY. No.	Name	Model & Caliber	REMARKS
	Miles	1	Herring	2-6" BC	
	"	2	Smith	2-16" BC	
	"	3	Const #519	2-12" BC	
	"	4	Hunter	2-6" BC	
5	"	5	-----	4-3" 15PDR	
	"	T-20	-----	4-8" Ry.	
	"	T-21	-----	4-8" Ry	
	"	T-22	-----	4-155mm	
	"	Mine	-----	23 Gps.	
9	Saulsbury	T-23	Hall	2-12" BC	To be moved Ref: 2nd Ind. OPD July 27 '42 on 1 tr. OPS No. 680.1 (4-11-42)
"	"	T-24	Haslet	2-12" BC	To be moved. Ref. AG680 (2-10-41) WPD 4861-20) OCCA 472.35/78 A-1
13	-	6	-----	2-3" 15 PDR	On List on Front Lt. Res. Bayview, Del.
14	DuPont	NONE	-----	-----	
15	Delaware	NONE	-----	-----	
16	Mott	T-25	Arnold	3-12" DC	
18	Cape May	T-26	--	2-155mm	
"	Res.	7	--	2-6" BC	

The numbers preceded by a "T" designate temporary batteries. Batteries Hall, Haslet and Arnold and all were "temporary", Hall and Haslet to be moved and Arnold at Fort Mott was slated for eventual salvage. Forts DuPont and Delaware had no armament listed.

This was concrete evidence of the accomplishment of the movement of armament and command to the sea at the mouth of the Delaware Bay. Another recognition of this fact was the redesignation of sub-posts and the fact that Fort Miles was designated as a seprary temporary post 2 October 1942.

In a communication the redesignation of subposts was made 23 October 1942 by the War Department (SOS) (Memo No. S210-6-42) in which the reassignment of subposts to Fort Miles was directed as follows: (ref. 319.26/142)

"Fort Saulsbury, Delaware, and Cape May, N.J., now subposts of Fort DuPont, Delaware, are designated as subposts of Fort Miles, Delaware."



During this period of armament readjustment and modernization work was being pushed on the mine field for the Delaware. The burden early "planting" of mines had borne by the USA Mine Planter Casey, and the "fleet of smaller "L" boats and yawls with the exception of the help given by visiting USA Mine Planters.

There were three of these short "visiting" mine planters brought into the Harbor Defenses of the Delaware for short stays of varying lengths of time during the spring and summer of 1942. The problem of planting a mine field in the mouth of the Delaware Bay was also presenting certain technical difficulties at the time and causing some concern.

The USAMP "Gen. Schofield arrived 18 March 1942 but stayed less than a month, returning 13 April 1942 to Fort Monroe, Va., due to the fact that the amount of shore work to be done before mine planting could be continued in the Harbor Defenses of the Delaware.

During August two "visiting" mine planters arrived in the Harbor Defenses of the Delaware to help the USA Jr. MP Casey. The USAMP "Ord" from the Harbor Defenses of New York arrived on 10 August 1942 and stayed until 28 August 1942 when it was replaced by the USAMP "Hunt" on 29 August 1942. The USAMP "Hunt" left Fort Miles 20 September 1942 in a convoy to "proceed to proper station."

The first of the new assigned mine planters to arrive at Fort Miles was the USA Mine Planter Sylvester manned by the Twelfth CAMP Battery which was activated at Point Pleasant, W. Va., and redesignated to Fort Miles, Delaware. The planter reported for duty with the Harbor Defenses of the Delaware 1 November 1942 according to the Armament Status Report of that date.

An S-1 report of the Harbor Defenses of 19 November 1942 noted that:

"The personnel previously designated as U.S.A.M.P. "1st Lt. Wm. G. Sylvester" have been redesignated by Secret letter, AG 320.2, WD., AGO, November 15, 1942 as: "12th Coast Artillery Mine Planter Battery, - assigned to Eastern Defense Command and attached to the U.S.A.M.P. "Sylvester" with station at Fort Miles, Del."

The UFA Mine Planter "Frank" did not arrive in the Harbor Defenses of the Delaware until six months later. It was assigned to that station by the War Department in an indorsement dated 19 December 1942 when its scheduled arrival was set at 1 May 1943. It actually arrived a month ahead of time according to an HDD S-1 report, the date being 1 April 1943. This mine planter was manned by the 19th CAMP Battery which was activated 28 November 1942 at Fort Hancock, N.J. and left that station on 16 December 1942 to join the "Frank" at Point Pleasant, W. Va. (Ref. 319.1/38 and /94) (Ref 320.2/756 NYPS #5)

On 12 November 1942 Batteries Best and Rodney, both 12-inch mortar batteries at Fort DuPont, were ordered transferred to the Ordnance Officer, Second Service Command, for salvage, the tubes to be turned over to the Chief of Ordnance "against probable future use" and the carriages disposed of as scrap. According to a report of 29 December 1942 the contract for salvage of these batteries had been let but actual operations had not been initiated.

The actual disposition of this obsolete battery was an indication of the house cleaning the Harbor Defenses was undergoing. Another sign of the time was the arrival in November 1942 of the mobile 90mm guns for Fort Miles that were to form the two 4-gun AMTB and antiaircraft batteries on Cape Henlopen and on Cape May. These batteries were to consist of two mobile and two fixed mounts each. The six fixed mounts, four for Fort Miles and two for Cape May were in the Harbor Defenses by the end of May 1943 and by the summer of 1943 were the proof and calibration fired.

During the closing months of 1942 and early 1943 repeated efforts had been made to activate the 2nd Battalion, 21st Coast Artillery, (HD) and searchlight Battery "G" in view of the increased manning obligations incurred by the completion

and addition of new batteries in the Harbor Defenses. This activation was not realized.

At the close of the year 1942 the report of the S-1 of the Philadelphia Subsector showed a total strength of 135 officers, 13 warrant officers and 2952 enlisted men in the command. The forces of the subsector remained fairly stable at this figure during the time it was in full operation or until the Battalion Combat Team of the 113th Infantry was removed from its command.

Of these totals 85 officers, 13 warrant officers and 1796 enlisted men were in the Harbor Defenses while 50 officers, no warrant officers and 1136 enlisted men were in the Battalion Combat Team. (Ref. 319.1/44)

With the new year came another reorganization of command for the Philadelphia Subsector. The Miles groupment was eliminated from the command due to the compact nature of the defense armament now located entirely on the capes. The Infantry Combat Team was still in the line of command, that command not disappearing until 1 November 1943. Otherwise, basically, this organization of command held until 1944.

The graphic representation of this reorganization was presented in General Orders No. 4, Headquarters Philadelphia Subsector and Harbor Defenses of the Delaware, dated 4 March 1943, and is reproduced on the following page, recinding that of General Order No. 12, dated 18 September 1942. (Ref. 320/117)

In this diagram it is seen that all sign of the older batteries have disappeared, those at Fort Saulsbury and Battery Arnold at Fort Mott. The only separate battery is that at Cape May. Battery 5-A, a 90mm battery appears as a new battery. The Bayview 3-inch battery has gone, its short life ended.

Battery Haslet, one of the 2-gun 12-inch batteries in Fort Saulsbury, the other being Battery Hall which was a non project battery and not manned, was scheduled to leave and be resited at Fort Miles in place of construction No.119, the number applied to the projected 2-gun 16-inch battery on Cape Henlopen that was eliminated from the project by the War Department 13 September 1942.

At about the time that this reorganization of command was being published, by the end of February 1943, Philadelphia Subsector had announced the establishment of liaison groups in the following Coast Guard Stations manned by the Battalion Combat Team, 113th Infantry.

Cape May Point, N.J.  
Avalon, N.J.  
Ocean City, N.J.  
Brigantine, N.J.

Wildwood Crest, N.J.  
Townsend's Inlet, N.J.  
Margate, N.J.

The facilities of Fort Miles were rapidly improving by 1943 armament status reports indicate. On 27 March 1943 the Harbor Defense Command Post (HDCP) moved from its old quarters in Bombproof No. 119 to the new HECF splinterproof. On 8 June 1943 the Harbor Control Post occupied its new station in the Fort Miles tower No. 9.

The condition of the Harbor Defense of the Delaware as on 1 May 1943 and the project organization were represented in chart prepared by Philadelphia Subsector for the Harbor Defense Project Annexes of 1943 and is reproduced here as Plate No. 16.

Another sign of the over improvement was the placing of the two AMTB 90mm batteries so that on 23 July 1943 old Battery No. 5, the hybrid 3-inch battery that was the first "fixed" armament to be ready for action on the Cape, was placed in class "B". This action was taken to meet the personnel requirements for manning the new 90mm Batteries by authority 1st ind., Headquarters Eastern Defense Command and First Army, dated 23 July 1943, subject: Personnel Requirements for New York Philadelphia Sector." (220.31/120)

The last evidence of the old order of defense of the Delaware vanished from the tactical sphere of the Harbor Defense Command by October 1943.

Upon action initiated by Sector letter of 31 August 1943 Forts DuPont, Delaware and Mott were eliminated from the Harbor Defenses of the Delaware. With them went two fixed 60-inch seacoast searchlights at Forts Delaware and DuPont, the outmoded mine casemate and accessory facilities at Fort DuPont and all abandoned gun emplacements, Motor Batteries, observing stations and accessory equipment. These ports passed to the jurisdiction of the Commanding General, Second Service Command. The action was approved by War Department Indorsement 22 September 1943 and made effective 1 Oct. 1943. (Ref. 320/168)

SECRET

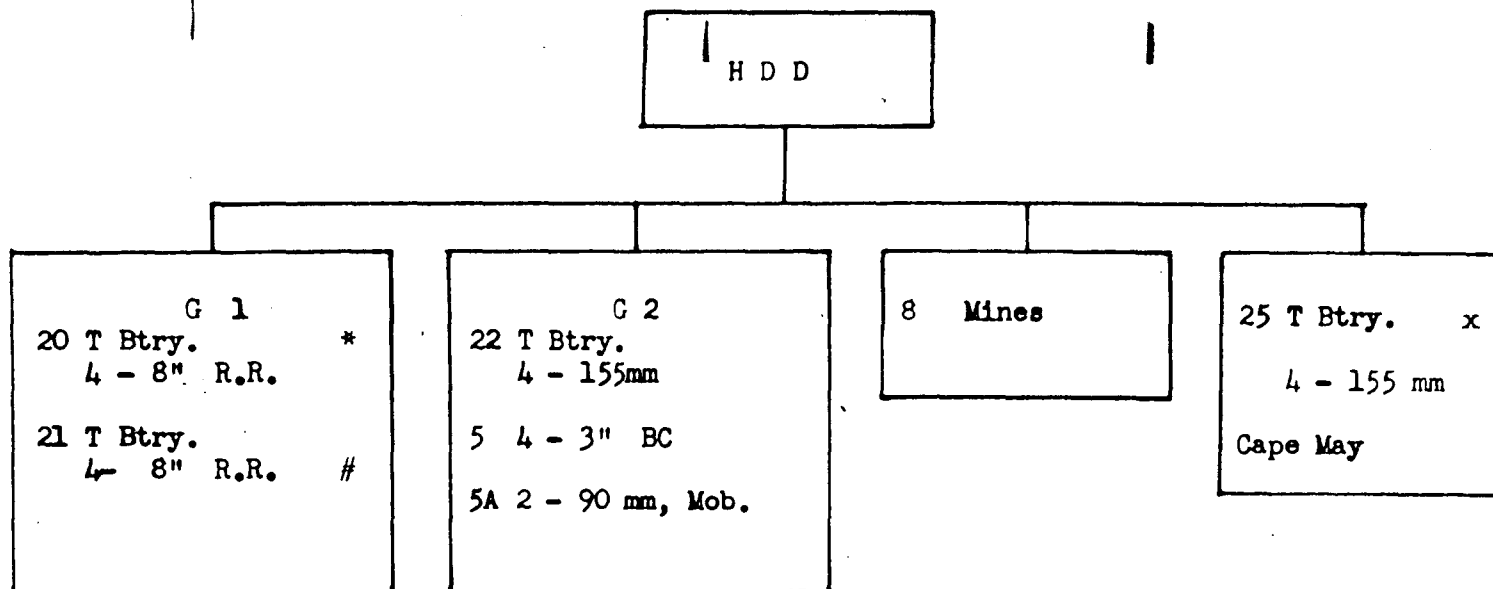

x Later desig. as Btry. 26 and grouped with mines as G-3.

\* 2 Guns of this Btry. are project Btry.  
# Not a project Btry.

CONDITIONS AS OF MAY 1, 1943.

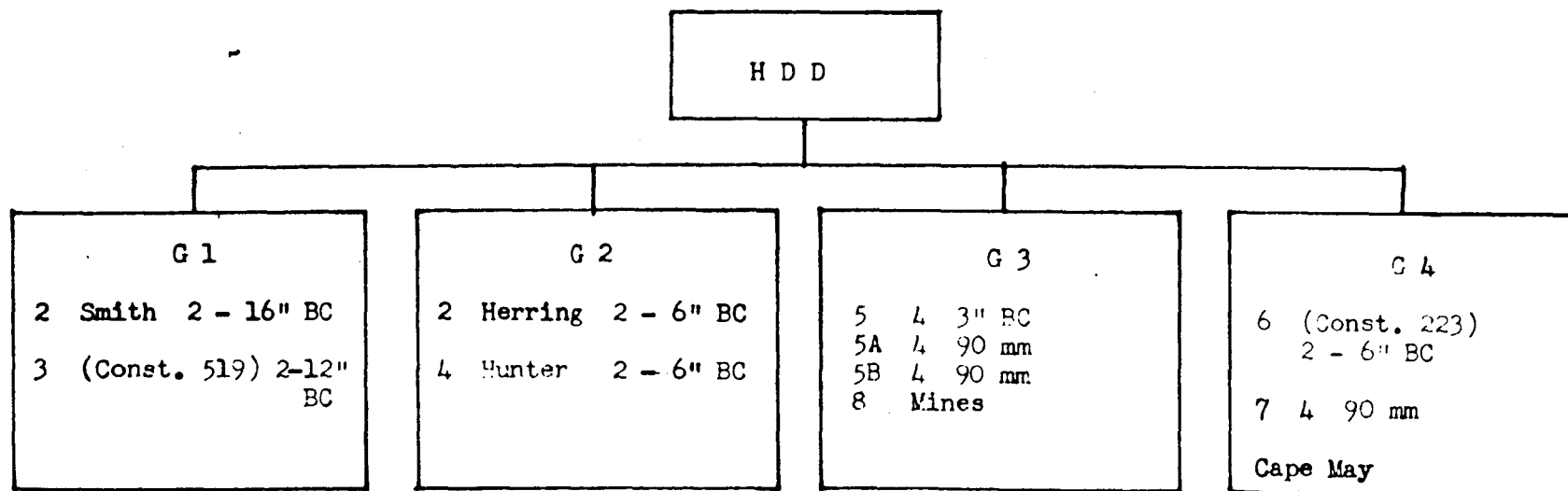

NON - PROJECT BATTERIES -- NOT MANNED  
T Btry. 23 - Hall 2 - 12" BC  
T Btry. 24 - Arnold 3 - 12" BC

PROJECTED

PLATE NO 16

The band of the Harbor Defenses of the Delaware was reorganized and redesignated the 240th Army Band by General Orders No. 1, Hq. New York-Philadelphia Sector, dated 3 January 1944, which read in part:

"Pursuant to authority contained in War Department letter, AG 322 (24 Dec 43) OB-I-GFGCT-M, 28 December 1943, subject: Reorganization and redesignations of Bands, and 1st Ind., Hq Eastern Defense Command, G-3 - 321/ Bands, 31 December 1943, the band HD of the Delaware, will be reorganized, effective 3 January 1944, in accordance with Column 2, T/O 5-21, 1 April 1942, with an authorized strength of one (1) warrant officer and twenty-eight (28) enlisted men.

"Concurrently with the above reorganization, the band, HD of the Delaware, is redesignated as the 240th Army Band.

"Upon redesignation, the 240th Army Band is assigned to the Harbor Defenses of the Delaware, with permanent station at Fort Miles, Delaware."

The Philadelphia Subsector suffered the same fate as that of the New York Subsector when the regime of the New York-Philadelphia Sector ended with the creation of Southeastern Sector. The same reorganization of 1 November 1943 that took the Combat Team troops from New York Subsector deprived Philadelphia Subsector of its command of the 2nd Battalion, 113th Infantry and for all purposes made the command of Philadelphia Subsector a duplicate of that of the Harbor Defenses of the Delaware. So with the planning for Southeastern Sector in January and February 1944 Philadelphia Subsector disappeared and Harbor Defenses of the Delaware carried on alone under the new higher command.

The units under command of Philadelphia Subsector and Harbor Defenses of the Delaware at the beginning of February 1944, the final days of Subsector, and their stations, were as follows:

PHILADELPHIA SUBSECTOR

Hq Det PSS	Fort Miles, Del.
<u>Harbor Defenses of the Delaware, Hq Btry</u>	Fort Miles, Del.
HECP, HDD	Fort Miles, Del.
240th Army Band	Fort Miles, Del.
21st CA (HD) Hq Btry	Fort Miles, Del.
Btry A	Fort Miles, Del.
Btry B (less Det)	Fort Miles, Del.
Btry C	Cape May, N.J.
Det Btry B	Fort Saulsbury, Del.
261st CA (HD) Hq Btry	Fort Miles, Del.
Btry A	Fort Miles, Del.
Btry B	Fort Miles, Del.
Btry C	Fort Miles, Del.
287th CA (Ry) Bn, Hq Btry	Fort Miles, Del.
Btry A	Fort Miles, Del.
Btry B	Fort Miles, Del.
12th CAMP Btry, USAMP "Sylvester"	Fort Miles, Del.
19th CAMP Btry, USAMP "Frank"	Fort Miles, Del.
USA Jr. MP "Casey"	Fort Miles, Del.



The units under command of Philadelphia Subsector and Harbor Defenses of the Delaware at the beginning of February 1944, the final days of Subsector, and their stations, were as follows:

PHILADELPHIA SUBSECTOR

Hq Det PSS	Fort Miles, Del.
<u>Harbor Defenses of the Delaware, Hq Btry</u>	Fort Miles, Del.
HEGP, HDD	Fort Miles, Del.
240th Army Band	Fort Miles, Del.
21st CA (HD) Hq Btry	Fort Miles, Del.
Btry A	Fort Miles, Del.
Btry B (less Det)	Fort Miles, Del.
Btry C	Cape May, N.J.
Det Btry B	Fort Saulsbury, Del.
261st CA (HD) Hq Btry	Fort Miles, Del.
Btry A	Fort Miles, Del.
Btry B	Fort Miles, Del.
Btry C	Fort Miles, Del.
287th CA (Ry) Bn, Hq Btry	Fort Miles, Del.
Btry A	Fort Miles, Del.
Btry B	Fort Miles, Del.
12th CAMP Btry, USAMP "Sylvester"	Fort Miles, Del.
19th CAMP Btry, USAMP "Frank"	Fort Miles, Del.
USA Jr. MP "Casey"	Fort Miles, Del.

HARBOR ENTRANCE CONTROL POST  
Harbor Defenses of the Delaware

The first appearance of a definite decision on the problem of the location of a Harbor Entrance Control Post in the Harbor Defenses of the Delaware was early in 1941. Then the Local Joint Planning Committee consisting of representatives of the Harbor Defense, the Fourth Naval District and the Second Coast Artillery District met and recommended on 6 March 1941 that a Harbor Entrance Control Post (HECP) be established in the "Army battery or mine field control station at Cape Henlopen, Delaware, when constructed. Until such construction the HECP should be located temporarily at the Section Base, Naval Air Station, Cape May, New Jersey, is immediately available for use." (Ref. 660.3/125 LJPC 2nd CAD)

The entrance to the Delaware Bay did not present the same problem that was found in the New York Harbor. The only feasible channel for shipping could be observed seaward from one station on Cape Henlopen and vessels could be signaled from the same station. There was no need of advanced HECPs or signal stations.

However no installations of the Army's that could be used as an HECP existed on Cape Henlopen so a temporary alternative had to be improvised, such as the location at Cape May advised by the Local Joint Planning Committee, in the interim. The only existing facility for a HECP was the Signal Station at Fort DuPont, Del., too far up the river to fit into the plans to guard the harbor entrance in modern warfare.

The Local Joint Planning Committee soon reversed itself on the plan to locate the temporary post on Cape May since that side of the Delaware Bay mouth was such a great distance from the ship channel and breakwaters that it was almost useless even as a temporary expedient. It was on 8 July 1941 that the Local

Joint Planning Committee decided that Delaware HECF should be located on Cape Henlopen even on a temporary basis. Eventually it was to be located in the Army Harbor Defense Command Post yet to be constructed but expected to be ready by the summer of 1942. The operation of the HECF was not to await this construction, the Committee decided, but would be housed in an old Coast Guard Station, then a civilian operated beach club (Bell Haven Surf Club) which could be available by 1 December 1941. (Ref. 660.3/167 2nd CAD)

This plan was followed but the gravity of the War situation here and abroad made speed essential. A temporary set-up was created with a tower and temporary building on Cape Henlopen, in the area that is Fort Miles and regulations for the operation of the HECF for the Harbor Defenses of the Delaware were issued, dated 26 August 1941. The Army section of the HECF was housed in tents. (Memo. No.27 Ref. 581/49 NET)

This situation existed while the Bell Haven Surf Club was being converted to the purpose of operating as an HECF for which the expenditure of \$10,900 was allotted. This temporary arrangement was evidently not very satisfactory. At least we find the Fourth Naval District, in a letter dated 16 October 1941, voicing dissatisfaction with the "make-shift set-up" of the HECF on the Delaware.

Whatever was wrong with the temporary HECF, however, did not prevent the Harbor Defenses of the Delaware, in General Orders No 18, putting the HECF on continuous alert on 28 October 1941.

Then, only three days before the alarm of Pearl Harbor and the entrance of the United States into World War II, the HECF for the Harbor Defenses of The Delaware moved into its next home, the converted Bell Haven Surf Club at Fort Miles, on 4 December 1941.

But the Bell Haven Surf Club was only to be intermediate step. However plans were changing by experience and the original plan for the HECP were no exception. The Local Joint Planning Committee on 8 May 1942 decided that the construction of an observation tower was necessary for the efficient operation of an HECP on Cape Henlopen and decided to abandon the proposition to use the Harbor Defense Command Post. (Ref. 660.3/231 LJPC)

So it was that, while the Harbor Defense Command Post moved to its new location from bombproof No. 119 to the HDOP splinterproof on 27 March 1943 the Harbor Entrance Control Post did not occupy its final home at Fort Miles, in the Fort's tower designated as tower No. 9, until 8 June 1943.

Incidentally the Signal Station at Fort DuPont, Delaware, was closed down on 7 June 1942.

DESCRIPTIONS  
of  
FORTS AND ARMAMENT  
(Harbor Defenses of The Delaware)

**KEY** The fixed batteries of the various forts in the Harbor Defense have been listed in tabular form for easy reference and keyed to avoid repetition of general information. The original list was taken from a list of batteries as they existed in the Second Coast Artillery District 15 July 1939 when all armament was classified as "in commission, out of service, caretakers" status.

The following symbols used, with their interpretations, are:

- (s) To be provided with shield as project of modernization program.
- (c) To be casemated as project of modernization program.
- (o) Outmoded battery to be abandoned upon completion of new batteries in modernization program.
- (n) No longer required in Harbor Defense project.
- (NC) New Construction.
- \* According to listing in supplement to project, Harbor Defenses of the Delaware dated 1943.
- † According to NYPPER-THREE, dated 15 December 1943.
- # As a matter of policy all 90mm AMTB batteries in the harbor defenses constituted two fixed and two mobile guns, with the exception of one battery on Swinburne Island, N.Y. The fixed mount was T-3 and the mobile M1A1. All mobile batteries were removed from sites and stored in local ordnance storage by order of New York-Philadelphia Sector 18 December 1943. All AMTB batteries after that date constituted two fixed guns only.

F O R T M I L E S, D E L.

Fort Miles, Del., located amid the sand dunes of Cape Henlopen, two miles from Lewes, Del., is named in honor of the memory of Lieutenant General Nelson Appleton Miles, Commanding General of the United States Army, 1895 to 1903. General Miles, born in Westminster, Mass., 8 August 1839, commanded an Army Corps during the Civil War at the age of 25 years. He received the Congressional Medal of Honor for "distinguished gallantry at Chancellorsville," and was cited for service at Reams Station and Spottsylvania. After the Civil War he received a permanent commission as Colonel in the 40th United States Infantry and later commanded the Fifth Infantry. He became a Brigadier General in 1880, Major General in 1890 and Lieutenant General in 1900. He also served in the Indian Wars as Commanding General of the Army during the Spanish-American War. General Miles was the last officer to hold the title of "Commanding General of the United States Army as the ranking officer has since been called "Chief of Staff." He retired in 1903 and died in 1908.

While the present-day fortifications of Fort Miles date from 1940 when plans for the Fort were first being executed, the site is one of historical associations. The oldest lighthouse (built in 1725 and rebuilt in 1764) in America south of Boston, was a famous landmark on Cape Henlopen until it toppled into the sea because of erosion by the sea in April 1926. The Fort is situated on a parcel of land which was originally granted by Penn, then Governor Of Pennsylvania, to the people of Lewes. Nearly 200 years later, in 1873, the original site of the military reservation was ceded by the citizens of Lewes and Sussex County, Delaware to the Federal Government. In subsequent years the reservation was expanded by additions of government lands originally acquired for Coast Guard Station, Lighthouse Reservation, Quarantine Reservation and Naval Reservation with other parcels of land obtained from the state of Delaware and private individuals, the last as late as 29 May 1940, until the reservation in January 1944 covered an area of some two square miles.

BATTERIES

<u>Name</u>	<u>Cal.</u>	<u>No. &amp; Mod.</u>	<u>Car.</u>	<u>Notes</u>
Smith (NC)	16"	2-Mk. II	BC	Named in honor of memory of Major General William R. Smith, United States Army (WD General Orders No. 11, dated 14 Oct. 1941) Battery range 44,00 yards.* Authorized before modernization program of 1940 but work not started before program inaugurated. Proof fired on or about 15 Sept. 1943. Status Jan. 1944 - Class "A".† To be retained.*

MILES BATTERIES  
(Cont'd)

<u>Name</u>	<u>Cal.</u>	<u>No. &amp; Mod.</u>	<u>Car.</u>	<u>Notes</u>
CONST. 519 (NO)	12"	2-1895M1	BC	Range 29,300 yards.* Became project battery for Fort Miles when it was decided to bring the armament of Battery Haslett to the site of Const. 119 (2-16") which it replaced (See Note). Emplacing began in March 1943. Status January 1944 - Class "B" (under construction).# To be retained.*
HERRING (NO) (Const. 221)	6"	2-1903AZ	BC	Named in honor of memory of Lieutenant Colonel Ralph E. Herring, CAO, U.S.Army. Battery range 27,500 yards.* Proof fired or or about 15 September 1943. Status January 1944 - Class "B".# To be retained*
HUNTER (NO) (Const. 222)	6"	2-1903AZ	BC	Named in honor of memory of Colonel Charles H. Hunter, CAO, U.S.Army. Battery range 27,500 yards.* Proof fired Nov. 1943. Status Jan. 1944 - Class "B".# To be retained.*
No. 5 (NO)	3"	4-1905	RF	Range 11,000 yards.* Made up of two guns of Battery Turnbull, Ft. Wadsworth, N.Y. and two guns of Battery Hentig, Ft. Delaware, Del. Emplaced and capable of going into action 11 September 1942, manned and in Class "A". Authorized placed in Class "B" 23 July 1943. Manning detail relieved of assignment October 1943. Status January 1944 - Class "C". # To be retained.*

Construction 119, which was to be a 16-inch battery of two guns to be located  
NOTE ed approximately on the identical site of the present project battery 519 that  
replaces it, was in the project until 13 November 1942 when the War Department  
file AG 660.2 (11-12-42) OB-S-E, eliminated it with eight others in the Eastern  
Defense Command "in order to place this (modernization) program in a workable con-  
dition and to effect a reduction in the requirements for seacoast batteries in  
line with the acute shortage of critical materials ....."

(Ref. Modernization File)

MILES BATTERIES  
(Cont'd)

<u>Name</u>	<u>Cal.</u>	<u>No. &amp; Mod.</u>	<u>Car.</u>	<u>Notes</u>
AMTB No. 5a (NC)	90mm	4-M1	(##)	Two guns emplaced by 26 February 1943 (mobile - one gun manned as of Armament Status Report 28 March 1943). Fixed guns in Harbor Defense 24 May 1943. Calibration firing 10 November 1943, placed in Class "A". Status January 1944 - Class "A".# To be retained.*
AMTB No. 5b (NC)	90mm	4-M1	(##)	Two guns emplaced by 26 February 1943 (mobile - two guns manned as of Armament Status Report 28 March 1943). Fixed guns in Harbor Defense 24 May 1943. Calibration firing 27 September 1943. Placed in Class "A".# To be retained.*
CONST. 223 (NC) (Cape May)	6"	2-T2	BC (M3)	Range 27,500 yards.* Carriages in place, guns being installed. Status January 1944 - Class "B" (under construction).# To be retained.*
AMTB No. 7 (NC) (Cape May)	90mm	4-M1	(##)	Four guns emplaced by June 1943. Functional firing on or about 15 October 1943. Battery assigned 8 November 1943. Calibration firing 18 November 1943. Status January 1944 - Class "A". # To be retained.*

-000-



FORT SAULSBURY

Fort Saalsbury, Del., located on the Delaware Bay Shore near Milford, Del., was the most modern fort of the Harbor Defenses of the Delaware at the outbreak of World War II, constructed on land acquired for that purpose in 1917. It was completed by the Engineers and turned over to the Coast Artillery 27 December 1920 and its construction may be ascribed to the increased interest in National defense inspired by World War I. The post was not garrisoned until 29 June 1941 when Battery "C" 21st CA manned Battery Hall. It turned to caretaking status 9 March 1943 when Battery "B" of the 261st CA, then manning Battery Hall, left and a caretaking detachment of nine men of the 261st CA were left in charge. It was a subpost of Fort DuPent, Del., and later, as it now (January 1944) is, a subpost of Fort Miles, Del. It was designated as a Fort in the true military meaning by verbal orders of the Commanding Officer, confirmed by General Orders No. 23, Headquarters Harbor Defenses of the Delaware, 20 December 1941.

The fort was named in honor of the memory of the Honorable Willard Saalsbury, Attorney General of Delaware 1850 to 1855, United States Senator 1859 to 1871 and Chancellor for the State of Delaware 1874 to 1892. (WD General Orders No. 130,4 Oct. 1917)

BATTERIES

<u>Name</u>	<u>Cal.</u>	<u>No. &amp; Mod.</u>	<u>Car.</u>	<u>Notes</u>
HASLET (n)	12"	2-1895M1	B <sup>C</sup>	Named in honor of memory of Colonel Charles Haslet, Continental Army, who raised the 1st Delaware Regiment in the Revolutionary War and was killed at Battle of Princeton, 3 January 1777. Battery range 29,300 yards.* designated to be dismantled and resited at Trinidad, B.W.I. early in 1941 but action withheld. Eliminated from Harbor Defense to be dismantled and transferred to Const. 519 (Fort Miles) instead of Battery Hall on WD authority received by District Engineers 8 Jan. 1943. Emplacing at Ft. Miles site began in March 1943. Status Jan. 1944 - Dismantled (See Const. 519, Fort Miles).

FORT SAULSBURY  
(Cont'd)

<u>Name</u>	<u>Cal.</u>	<u>No. &amp; Mod.</u>	<u>Car.</u>	<u>Notes</u>
HALL	12"	2-1895M1	BC	<p>Named in honor of memory of Colonel David Hall, Continental Army, badly wounded at Battle of Germantown. Served as Governor of Delaware. Died 18 September 1817.</p> <p>Battery Range 29,300 yards.* Battery authorized to be moved to form armament of Const. 519 (Fort Miles) 27 July 1942. Contemplated move cancelled and District Engineer authorized to move Battery Haslet instead 8 January 1943. On temporary status in 1943 being maintained in Class "B" with direction that armament be dismantled upon completion of Const. 519. Ordered placed in Class "C" upon completion of Const. 519 by War Department letter 8 January 1944 and all instructions reference dismantling rescinded. Status January 1944 - Class "C" To be retained.</p>

## FORT DUPONT, DEL.

Fort DuPont is named in honor of the memory of Rear Admiral Samuel F. DuPont who served conspicuously in the United States Navy. He as a member of a prominent Delaware family.

The fort, on the Delaware River shore south of Delaware City and opposite Fort Delaware, was originally known as "Ten Gun Battery" and supported Fort Delaware. This battery was completed in 1864. The work on the "new" fort was begun in 1872 and was completed in 1876. It was named DuPont by War Department Order July 22, 1899 and improvements were made in 1899 and 1900.

The first garrison was supplied by the 4th Artillery with Major E. V. Andrus in command and arrived June 10, 1897. The fort was predominately an Engineers post from 1922 to the outbreak of World War II., it was removed as a part of the tactical command of the Harbor Defenses of the Delaware 1 October, 1943.

### BATTERIES

<u>Name</u>	<u>Cal.</u>	<u>No. &amp; Mod.</u>	<u>Car.</u>	<u>Notes</u>
RODNEY (n)	12"	4-1890M1	Mort.	Named in honor of the memory of Caesar Rodney, a signer of the Declaration of Independence and a Major General of Militia in the Revolution who died 6 June 1784. The battery was not manned and in Class "C" in 1941, to be abandoned. Ordered transferred to Ordnance Officer, 2nd Service Command for salvage 12 November 1942. Status Jan. 1944 Dismantled.
BEST (n)	12"	4-1890M1	Mort.	Named in honor of the memory of Major C.L. Best, Artillery, who served with distinction in the War with Spain and died 14 April 1903. Battery Best was once a part of Battery Rodney. Battery not manned and in Class "C" in 1941 and to be abandoned. Ordered transferred to the Ordnance officer, 2nd Service Command for salvage 12 November 1942. Status January 1944 - Dismantled.

FORT DIBONT

(cont't)

<u>Name</u>	<u>Cal.</u>	<u>No. &amp; Mod.</u>	<u>Car.</u>	<u>Notes</u>
ELDER (s) (Bayview)	3"	2-1903	RF	Named in honor of memory of Brevet Lieutenant Colonel Samuel C. Elder, U.S. Army, Major 2nd Regiment, U.S. Artillery. Served with distinction during Civil War. Died 6 April 1885. Battery manned in December 1941, Class "A". Moved to Liston Front Range, Bayview, and manned by 14 May 1942 on new site. Out of action and in storage at Fort Sausbury, Del., 6 February 1943. Status January 1944 - In local ordnance storage.

F O R T M O T T, N. J.

Fort Mott, N.J., is named in honor of Major General Gersham Mott, a native of New Jersey, who served with distinction in the Civil War. He died 29 November 1864.

The Fort is located opposite Fort Delaware, a mile away, on the New Jersey shore, six miles from New Salem, N.J. Work on the original emplacements in support of Fort Delaware was begun about 1873. Guns were mounted in 1878 but no troops were stationed with them. The work on the "modern" fort was begun in 1896. The first garrison consisted of Battery "I", Fourth Artillery, arriving from Washington Barracks 14 December 1897. The fort was regularly garrisoned until 1922. It passed from the tactical organization as a fort in the Harbor Defenses of the Delaware 10 October 1943.

BATTERIES

<u>Name</u>	<u>Cal.</u>	<u>No. &amp; Mod.</u>	<u>Car.</u>	<u>Notes</u>
ARNOLD (n)	12"	2-1888 1-1888M2	DC	First eliminated as a project by the War Department 27 September 1940. Order is reversed by WD and decide to retain Arnold and abandon Torbet, Fort Delaware instead 21 October 1940. Not manned but maintained in Class "B". Final disposal authorized by WD 22 September 1943. Status January 1944 - To be dismantled.
HARKER (n)	10"	2-1888 1-1888M1	DC	Named in honor of memory of Brigadier General Charles G. Harker, U.S. Volunteers who served with distinction in the Civil War and was killed 27 June 1864 in the Battle of Kennesaw Mountains, Georgia. Battery Classed "no longer required" by the War Department in 1933. Canadian Government authorized to take guns for shipment to Canada 6 February 1941. Status January 1944 - Only emplacement remains.

F O R T D E L A W A R E , D E L .

Fort Delaware, Del., is named for its location in the Delaware River, on Pea Patch Island, some 70 miles up river from the Delaware Breakwater. The Island was ceded to the United States by the State of Delaware 27 May 1813. The old fortifications were begun by a Captain Clark with 100 soldiers and 30 laborers in 1814. The original fort was virtually completed by 1823 but was partially destroyed by fire 10 February 1831 when the garrison of 150 men and officers fled over the ice of the river to escape.

Work on the new fortifications was begun in 1836 but high tides wiped out the works. Work was restarted in 1848 by Major John Saunders, U.S. Engineer Corps, and construction, after much delay, was completed 1 July 1860. Guns were mounted from 1861 to 1865 until 121 guns of different calibers were mounted.

In the later years of the Civil War the Fort served as a prison depot for prisoners of war. It has been alternately garrisoned and on a caretaking basis. It was removed from the tactical command of the defenses of the Delaware 1 October, 1943.

BATTERIES

<u>Name</u>	<u>Cal.</u>	<u>No. &amp; Mod.</u>	<u>Car.</u>	<u>Notes</u>
TORBET (n)	12"	3-1896	DC	Named in honor of memory of Captain T.A. Torbet, 15th U.S. Infantry, Major General U.S. Volunteers. Served with distinction in the Civil War. Drowned at sea 8 Aug. 1880. Battery's abandonment authorized by the War Department 21 October 1940. Guns dismantled and shipped to Watervliet Arsenal in November 1940. Carriages scrapped in March 1943.
HENTIG (s)	3"	2-1903	R	Named in honor of memory of Captain Edmund C. Hentig, 6th U.S. Cavalry, killed 13 August 1881 in Arizona Territory in Indian Wars. Manned and in Class "A" December 1941. Abandoned and guns moved to Fort Miles 7 June 1942 to make up 4-gun, 3-inch rapid fire battery there (No. 3) with the addition of 2 guns of Battery Turnbull, Fort Wadsworth. (See Battery No. 5, Fort Miles, for January 1944 status of guns.)

GENERAL NOTES

Temporary batteries, 155mm, fully manned December 1941. Two batteries one at Cape Henlopen (Fort Miles) and the other at Cape May on Panama Mounts early in 1942. Second 155mm battery on Cape Henlopen (not on Panama Mounts) shipped out by 25 April 1942. Remaining batteries (on Panama Mounts) at Capes Henlopen and May eliminated from list of batteries in Harbor Defense project and no longer manned 8 November 1943 due to completion of modernization new construction projects.

The guns and carriages of both batteries were removed from Panama Mounts and the guns shipped to the Baldwin Locomotive Works, the Fort Miles guns 1 February 1944 and the Cape May guns 4 February 1944.

One battery of 8-inch railway artillery (Battery "C", 2nd Bn, 52nd CA) was emplaced in the Harbor Defense at Fort Miles 25 April 1942. The second battery (Battery "D", 2nd Bn, 52nd CA) of railway artillery was emplaced by 9 November 1942. Both railway batteries (287th Sep Bn) remained in the Harbor Defense as of January 1944, status Class "A".

SECTION IV

General Information

Story of Headquarters  
Coast Artillery District, Sector Commanders  
Coastal Defense (definitions)  
    Harbor Defense Units  
    Categories of Defense  
    Classes of Material

---

NOTE The definitive parts of this section have been abstracted from various official publications and are for the general information of those who may want to recall the meaning of terms, as applied to coastal defense, which are used in the preceding sections. It does not constitute an official compilation. The original, official, basic documents should be referred to if information beyond the scope of the purpose stated above is desired.



---

STORY OF

HEADQUARTERS\*

Prior to the summer of 1931 the Headquarters of the Second Coast Artillery District was located at Fort Totten, Long Island, N.Y. It was on 30 March 1931 that the Commanding General of the District, Brigadier General H.J. Hatch recommended that the headquarters of the District be moved from Fort Totten to 39 Whitehall Street. The purpose of the move was stated as to bring the District Headquarters into closer touch with the National Guard and to bring Officers Reserve Corps which had offices in the same Army Building. After due approval the move was ordered on 16 May 1931 by General Hatch and effected on 11 June 1931.

The move apparently was not satisfactory for 14 June 1932 Colonel F.K. Fergusson, then commanding the Second Coast Artillery District, requested a move back to Fort Totten and cited savings of \$5649.60 annually in allowances if such a move was made. But in spite of this District Headquarters remained at 39 Whitehall Street until moved to 641 Washington Street, Federal Building, N.Y.C., on 6 July 1933.

Nearly six years later another move was made, 3 May 1939, to 90 Church Street.

The move to present headquarters at Fort Hamilton was made by the Second Coast Artillery District on 5 March 1941. When the District became New York-Philadelphia Sector the headquarters at the building in Fort Hamilton. As activity expanded the functions of headquarters a wing was built on the rear in the summer of 1943.

The headquarters remained at Fort Hamilton as long as New York-Philadelphia Sector was in existence. With the organization of the Southeastern Sector the headquarters at Fort Hamilton were abandoned by the General Staff and new headquarters established at Raleigh, North Carolina, a site nearer the center of activities of the expanded command which absorbed the greater part of the New York-Philadelphia Sector and the Chesapeake Bay and Southern Sectors.

---

\*NOTE - Headquarters Second Coast Artillery District was organized 5 October 1920. Headquarters before 1930 have not been traced here.

LIST OF DISTRICT COMMANDERS

<u>NAME</u>	<u>RANK</u>	<u>DATES OF COMMAND</u>
John V. White	Colonel, CAC	Feb. 21, 1913 - Mar. 9, 1914
Charles J. Bailey	Maj. Gen. U.S.A.	Mar. 9, 1914 - Sep. 14, 1914
Samuel E. Allen	Colonel, CAC	Sep. 14, 1914 - Oct. 1, 1914
John V. White	Colonel, CAC	Oct. 1, 1914 - Apr. 9, 1915
Harry F. Hodges	Brig. Gen. U.S.A.	Apr. 9, 1915 - Aug. 24, 1917
Willoughby Walke	Brig. Gen. U.S.A.	Sep. 2, 1917 - Jan. 14, 1919
John D. Barrette	Brig. Gen. U.S.A.	Jan. 14, 1919 - May 8, 1919
Willoughby Walke	Brig. Gen. U.S.A.	May 9, 1919 - Jul. 20, 1919
Charles J. Bailey	Maj. Gen. U.S.A.	Jul. 21, 1919 - Jul. 20, 1921
Robert F. Callan	Brig. Gen. U.S.A.	Jul. 21, 1921 - Nov. 23, 1921
Willoughby Walke	Brig. Gen. U.S.A.	Nov. 23, 1921 - Feb. 23, 1922
Andre W. Brewster	Maj. Gen. U.S.A.	Feb. 14, 1922 - Dec. 31, 1922
Willoughby Walke	Brig. Gen. U.S.A.	Jan. 1, 1923 - Jan. 28, 1923
James F. Brady	Colonel, CAC	Jan. 29, 1923 - Mar. 4, 1923
Hugh A. Drum	Brig. Gen. U.S.A.	Mar. 5, 1923 - Dec. 3, 1923
Charles H. Hilton	Colonel, CAC	Dec. 4, 1923 - Dec. 10, 1923
Gorden G. Heiner	Colonel, CAC	Dec. 11, 1923 - Jul. 29, 1924
Johnson Hagood	Brig. Gen. USA & Maj. Gen. U.S.A.	Jul. 30, 1924 - Sep. 30, 1925
Gordon G. Heiner	Colonel, CAC	Oct. 1, 1925 - Oct. 9, 1925
William M Cruikshank	Brig. Gen. U.S.A.	Oct. 10, 1925 - Jan. 28, 1927
Marcellus G. Spinks	Colonel, CAC	Jan. 28, 1927 - Apr. 15, 1927
Alston Hamilton	Brig. Gen. U.S.A.	Apr. 16, 1927 - Sep. 9, 1927
Marcellus G. Spinks	Colonel, CAC	Sep. 10, 1927 - Sep. 20, 1927
William R. Deores	Colonel, CAC	Sep. 21, 1927 - Sep. 27, 1927

LIST OF DISTRICT COMMANDERS (Cont.)

Marcellus G. Spinks	Colonel, CAC	Sep. 28, 1927 - Oct. 23, 1927
Stuart Heintzeleman	Brig. Gen. U.S.A.	Oct. 24, 1927 - Jul. 7, 1929
Frank K. Fergusson	Colonel, CAC	Jul. 8, 1929 - Nov. 22, 1929
Andrew Moses	Brig. Gen. U.S.A.	Nov. 24, 1929 - Feb. 28, 1930
Henry J. Hatch	Brig. Gen. U.S.A.	Feb. 29, 1930 - June 22, 1931
Jacob C. Johnson	Colonel, CAC (7th CA)	June 23, 1931 - July 31, 1931
Henry J. Hatch	Brig. Gen. U.S.A.	Aug. 1, 1931 - Dec. 31, 1931
Frank K. Fergusson	Colonel, CAC	Jan. 1, 1932 - Nov. 4, 1932
William E. Cole	Brig. Gen. U.S.A.	Nov. 5, 1932 - Jan. 20, 1936
Frank K. Fergusson	Colonel, CAC	Jan. 20, 1936 - July 18, 1937 (died)
William S. Bowen	Colonel, CAC	July 18, 1937 - July 23, 1937
Walter K. Wilson	Brig. Gen. U.S.A.	July 24, 1937 - Dec. 5, 1937
Earl Biscoe	Colonel, CAC	Dec. 6, 1937 - Aug. 21, 1938
Avery J. Cooper	Colonel, CAC	Aug. 22, 1938 - Oct. 31, 1940
Earl Biscoe	Colonel, CAC	Nov. 1, 1940 - Dec. 3, 1940
Forrest E. Williford	Brig. Gen. U.S.A.	Dec. 4, 1940 - Nov. 28, 1941

PROVISIONALLY BECAME NEW YORK-PHILADELPHIA FRONTIER DEFENSE SECTOR UNDER THIS COMMAND? DECEMBER 10, 1941.

Arthur G. Campbell	Brig. Gen. U.S.A.	Nov. 29, 1941 - Dec. 17, 1941
--------------------	-------------------	-------------------------------

BECAME NEW YORK-PHILADELPHIA FRONTIER DEFENSE SECTOR UNDER THIS COMMAND, MARCH 1, 1942.

Ralph E. Haines	Brig. Gen. U.S.A.	Dec. 18, 1941 - Dec. 29, 1942
-----------------	-------------------	-------------------------------

BECAME NEW YORK-PHILADELPHIA SECTOR UNDER THIS COMMAND, OCTOBER 1, 1942.

Phillip S. Gage	Brig. Gen. U.S.A.	Sep. 30, 1942 - Oct. 8, 1942
-----------------	-------------------	------------------------------

John L. Homer	Maj. Gen. U.S.A.	Oct. 9, 1942 - Feb. 24, 1944
---------------	------------------	------------------------------

COASTAL DEFENSE

(Abstracted from (Joint Action Army - Navy) 1935)

Purpose of Coastal Frontier Defense.

The measures and operations in Coastal Frontier Defense are for the purpose of:

- (1) Protecting shipping in the coastal zones.
- (2) Protecting our military and civil installations and facilities.
- (3) Preventing invasion of United States territory from overseas.
- (4) Insuring the security of those portions of our coastal frontiers which are vital to military, industrial, and commercial operations.

Attacks classified.

Major operations - those executed for the purpose of invasion and  
Minor Operations - or raids against shipping or shore objectives

Responsibility of the Army.

The responsibility of the Army on the coast is defense of the coast, defense of permanent naval bases, and protection of the United States from internal disorder.

Specific functions of the Army in coastal defense.

1. To provide and operate the mobile land and air forces required for the direct defense of the coast.
2. To provide, maintain and operate essential harbor defenses in carrying out these functions, the Army will provide and operate, or maintain.
  1. Guns on land, both fixed and mobile, with necessary searchlights and fire control installations.
  2. Aircraft operating in support of harbor defenses; in general coastal frontier defense; in support of or in lieu of naval forces.
  3. A communication and intelligence system to include an aircraft warning service, among the elements of the land defense with provisions for the prompt exchange of information or instructions with the Navy.
  4. Controlled mines and their appurtenances, including the vessels necessary for their installation and maintenance.
  5. Beach defense together with vessels necessary for its installation, maintenance and patrol.\*
  6. Fixed underwater obstructions in connection with controlled mine barges.
  7. Additional mobile forces required in accordance with the situation.

---

\*NOTE - Reference file 560/12, dated 20 June 1942 in which Commander, Third Naval District, considers that all inshore vessels should be under District Control.

Responsibility of the Navy.

The general function of the Navy in Coastal Frontier Defense is to conduct Naval operations to gain and maintain command of vital sea areas and to protect the sea lanes vital to the United States, thereby contributing to the defense of the coastal frontiers.

The specific functions of the Navy in Coastal Frontier Defense are:

1. To control and protect shipping in the coastal zones.
  2. To conduct naval operations directed toward the defeat of any enemy force in the vicinity of the coast.
  3. To support the Army in repelling attacks on coastal objectives.
- In carrying out these functions the Navy will:

1. Provide and operate:

(a) A system of offshore scouting and patrol to give timely warning of an attack, and, in addition, forces to operate against enemy forces in the vicinity of the coast.

(b) A communication and intelligence system among the elements of the sea defense, with provisions for the prompt exchange of information or instructions with the Army.

(c) Contact mines, nets, and booms, including the vessels necessary for their installation and maintenance.

(d) Inshore patrols for the protection of mine fields and underwater obstructions other than beach defense; for the control and protection of shipping in passage through defensive sea areas; for the control of shipping in defensive coastal areas; and for the prevention of enemy mining and submarine operations.

(e) Underwater listening posts for naval use.

(f) Through the Lighthouse Service, when turned over to the Navy, coastal lights, buoys, and aids to navigation, and to change them as necessary.

(g) An information system through the Coast Guard stations when turned over to the Navy, and through light houses and light vessels.

(h) Necessary mine-sweeping vessels.

2. Provide and maintain such fixed underwater obstructions as are component parts of Navy barrages; including the vessels necessary for their installation and maintenance.

3. Operate gates through nets.

4. Conduct shipping through channels in mine fields or obstructions.

DEFINITIONS (Ref. AR 90-30) (Abstracted from Army Regulations 90-30)

Coast Artillery District: A Coast Artillery District is a tactical command which includes all harbor defenses located within a specified area and such mobile Coast Artillery units as may be assigned or attached thereto.

Designations: Coast Artillery Districts are designated as follows:

- First Coast Artillery District
- Second Coast Artillery District
- Third Coast Artillery District
- Fourth Coast Artillery District
- Ninth Coast Artillery District

The First to Fourth Coast Artillery Districts cover the coastline of Eastern United States and the Ninth Coast Artillery District the Pacific Coastline of the United States. The designation of Coast Artillery Districts is suspended for duration of present (January 1944) emergency.

Boundary: (Second Coast Artillery District): The northern boundary Nantucket Shoals Lightship, Shinnecock Light, both inclusive; longitude 72 29 west, Connecticut-New York boundary (in Long Island Sound and on mainland). The Southern boundary is Winter Quarter Shoal Lightship, inclusive; southern and western boundary of Delaware. The First Coast Artillery District lies to the north of the Second Coast Artillery District and the Third Coast Artillery District lies to the south of the Second Coast Artillery District.

Defense Command: The Defense command is a territorial agency, within the continental United States, with appropriate staff designated to coordinate or prepare and to initiate the execution of all plans for the employment of Army forces and installations in defense against enemy action in the portion of the United States lying within the command boundaries. (Ref. FM 31-10)

Sector\*: A sector is one of the subdivisions of a defense command. (New York-Philadelphia Sector is currently - a part of the Eastern Defense Command.) (Ref. FM 31-10)

Subsector\*: A subsector is one of the subdivisions of a sector. (New York-Philadelphia Sector is made up of New York Subsector and Philadelphia Subsector - (January 1944.)

Local Sectors: \* A local sector is one of the subdivisions of subsector. (Local subsectors in Philadelphia Subsector are Delaware Local Sector and Southern New Jersey Local Sector. Local sectors in New York Subsector are Northern New Jersey Local and Long Island Local Sector - (January 1944).)

---

\* The terms sector, subsector and local sector are based largely on geographical considerations, in order to avoid, as far as practicable division of responsibility for the defense of important areas which also are possible objectives for the enemy. These terms should not be confused with the term sector as used in purely land defense where the limits are dependent upon the tactical units occupying the areas, such as corps sector, division sector or regimental sector. It should be noted that all sectors may not be divided into subsectors such as the Chesapeake Bay Sector which has no subsectors.

DEFINITIONS (Abstracted from Joint Action, Army-Navy, 1935)

A Coastal Frontier is a geographical division of our coastal area established for organization and command purposes in order to insure the effective coordination of Army and Navy forces employed in coastal frontier defense .... Within each coastal frontier an Army officer and a naval officer will exercise command over all Army force and Navy forces, respectively, assigned for the defense of these definitions. Coastal frontiers are subdivided for command purposes into sectors and subsectors.

The naval district is a military and administrative command ashore established for the purpose of decentralizing the Navy Department's function with respect to the control of shipping in the coastal zones and the shore activities outside the Navy Department proper ..... The primary purpose in view is to provide for naval mobilization and logistic support of the Fleet and to utilize the district forces in the joint organization to provide security for the coast and for whipping in the coastal zones.

Naval local defense forces consist of naval forces, including Coast Guard and Lighthouse Service, afloat and ashore, attached to a naval district and under the command of the commandant of the district. These forces are not a part of the Fleet.

A corps area is a territorial and administrative command within the continental area of the United States, established for purposes of administration, training and tactical control during peacetime and for the conduct of mobilization and other functions of the zone of the interior in war.

A coast artillery District is a military command within a certain corps area which contains harbor defenses. It is established for the purpose for decentralizing the corps area commanders functions of discipline, instruction and routine training of the coast artillery troops within the corps area. When frontier commands, sectors and subsectors come into active existence, coast artillery districts as such cease to exist and all coast artillery troops, including the district staff, located within the frontier, sector and subsector, automatically become part of the frontier, sector or subsector command as the case may be.

A defensive coastal area \* is a part of a coastal zone and of the land and water area adjacent to inshore of the coastline which defense operations will involve both Army and Navy forces, and in consequence require effective coordination. A defensive area pertaining to a fortified harbor includes the outer area, the channel area, and the inner harbor area; its outer limits which, are specified in each case by joint plans, are the outer limits of the ranges of the shore defense batteries when a defensive sea area or a maritime control area and a defensive coastal area coexist in any one locality, the water area of the defensive coastal area which lies within its outer limits and the inner limits of the harbor channel area, shall be considered superimposed upon a like portion



of the defensive sea area or maritime control area without in any way detracting the Army's responsibility for the direct defense for the coast. Defense activities in that portion of a defensive sea or maritime control area not included within a defensive coastal area are essentially naval in character but are of immediate interest to the Army as by such means are disclosed the presence and indicated objectives of enemy forces.

A defensive sea area\* is a portion of a coastal zone set apart and placed under the control of the Secretary of the Navy by executive order. Defensive sea areas are established in and about the approaches to and the waters of important ports, harbors, bays or sounds. .... Do not extend beyond U.S. coastal waters ...

(1) For control of shipping, its protection; especially from sabotage, from our own mine fields, from obstructions and from the danger of being considered hostile.

(2) For the safeguarding of defense installations bordering on waters of the areas; and

(3) For providing any other measures of a security nature needed within the specified areas.

A harbor defense is an administrative and tactical Army command, commanding, comprising the armament and accessories, provided for the defense of a harbor or other water area. Harbor defenses exist to provide on the outbreak of war and effective seaward defense important strategic points, such as large centers of population, important commercial centers, Navy yard, coaling or fueling stations, locks and dams, to deny the enemy entrance to or occupation of the harbor or other waters which might serve as a base for land or naval operations, or both, and to keep the enemy as such distance for the entrance to a waterway that our naval forces may debouch therefrom and take up battle formation with the least hostile interference. War time personnel of the Army in these (Harbor Defenses) areas will consist essentially of harbor defense troops reinforced by Army air elements. In the usual case mobile troops will be limited to those manning reinforcing mobile artillery, railway and tractor, allotted to seacoast defense. The harbor defense troops themselves will thus have the mission of beach defense in the vicinity of the batteries. A limited number of mobile troops may be assigned to the harbor defense for local beach defense; the further reinforcement of the area by mobile troops will, in general, not take place until the enemy situation indicates an attack in force involving landings and requiring a considerable mobile force for defense against landing attacks.

Fort: A land area within a Harbor Defense wherein are located harbor defense elements. It is organized principally as an administrative command designated to provide centralized control over administrative and technical details pertaining to personnel and material located therein under certain circumstances it is employed as a tactical unit and its organization must provide for such employment.

---

\*NOTE - Defensive Coastal Areas within New York-Philadelphia Sector were New York (Southern entrance) and Delaware Bay River. Defensive Sea Areas within Sector were New York Bay and Delaware Bay. (From Joint Action Army-Navy, 1935)

HARBOR DEFENSE UNITS  
(Abstracted from F M 4-5)

**GENERAL** - Coast Artillery troops to be assigned to harbor defense armament are organized as regiments if types "A," "B," "C," or as separate battalions, type "D". The type of organization assigned to a harbor defense is governed by tactical requirements of the harbor defense.

**REGIMENT, TYPE "A" (T/O 4-61)**- Type "A" harbor defense regiment consists of a headquarters and headquarters battery, a band, searchlight battery, and three battalions of three firing batteries each, with medical personnel and a chaplain attached. In time of war all of the organizations except the band are increased in size, but the number of organizations remains unchanged.

**REGIMENT, TYPE "B" (T/O 4-71)** - The principal difference between type "B" harbor defense regiment and type "A" regiment (par. 8a) is that type "B" regiment has only two battalions of three batteries each instead of three. Additional differences are found in sizes of the headquarters and headquarters battery and the medical detachment.

**REGIMENT, TYPE "C" (T/O 4-81)** - The principal difference between type "C" harbor defense regiment and type "A" regiment (par. 8a) is that type "C" regiment has four battalions of three each instead of three. Additional differences are found in sizes of the headquarters and headquarters battery, the medical detachment, and the number of chaplains attached.

**BATTALION, TYPE "A," "B" AND "C," (T/O 4-65)**- The battalion consists of a headquarters and headquarters battery and three firing batteries. In time of war each of these organizations is increased in size, but the number of organizations remains unchanged.

**SEPARATE BATTALION, TYPE "D" (T/O 4-95)**- The separate battalion, type "D", is organized for the purpose of providing a unit smaller than a regiment for arming a small harbor defense. It consists of a headquarters and headquarters battery and three firing batteries at peace strength or five at war strength with medical personnel and a chaplain attached. Neither a band nor a searchlight battery is assigned to the separate battalion.

## BATTERY

**DEFINITION** - The battery is the basic combat unit of the harbor defense.

The gun (howitzer or mortar) battery consists of one or more guns (Howitzers or mortars), fixed or mobile, of the same caliber and characteristics employed against a single target at a time, together with all structures, equipment, and personnel necessary for their emplacement (in case of mobile weapons), and service.

The mine battery consists of the personnel, structures, and equipment other than mine planters and auxiliary boats necessary for installation, operation, and maintenance of all or part of the controlled mine fields. Personnel of the mine battery operate and maintain distribution box boats, motor mine yawls, and rowing mine yawls. The mine group commander is in charge of these boats or designates an officer under his command for that duty. The planting section of the mine planter is part of the mine battery. The mine planter is operated by the mine planter detachment and not by the mine battery.

The searchlight battery consists of the personnel, material, equipment, and structures necessary for emplacement (in case of mobile searchlights), operation, and maintenance of all searchlights, seacoast or antiaircraft, normally assigned to a harbor defense.

## GROUP

**DEFINITION** - The group is a tactical unit of the harbor defense formed for the purpose of fire direction.

The gun group is a tactical unit composed of two or more gun (howitzer or mortar) batteries, mobile or fixed, whose weapons are suited for employment against the same or similar targets, and whose normal fields of fire cover the same general water area, together with personnel and installations necessary for employment of the group as a unit.

The mine group is a tactical unit composed of the personnel, submarine mine material, structures, vessels, and armament necessary to plant, operate, maintain, and protect part or all of the controlled mine fields of a harbor defense. It is also administrative and supply unit on respect to mine property.

## GROUPMENT

**DEFINITION** - a groupment is a tactical command containing two or more groups or separate batteries whose fields of fire cover a certain water area, together with personnel and material required for its employment as a unit. A portion of the water area of one groupment may be covered by batteries of another groupment.

## CATEGORIES OF DEFENSE

---

### Foreward

The categories of defense as employed by the Eastern Defense Command and New York-Philadelphia Sector fall in two groups. The one is designated by numbers - 1, 2, 3, - and the other by letters - A, B, C, etc. While there is a connection between the two, they are designed to meet two distinct needs. The lettered categories are set by the War Department according to definitions laid down by Joint Action Army-Navy, 1935, and are based on expectancy and intensity of enemy assault as determined by military intelligence. They are applied to the coastline or military area concerned in general. Condition one, two or three are determined by the tactical command on the scene and may be applied to Subsector, Harbor defense or specific armament. It also could be applied to Sector or Defense Command but an attack of that scope would appear to be without the realm of probability in any case.

The use of numbered categories obviates the necessity of detailed or lengthy orders to meet an emergency or attack by an enemy. The use of one category classification does not necessarily demand the use of another. For example Category E represents the greatest danger for the military area to which it is applied. But the application of Category E does not put all elements in Condition one. It is obvious that a state of readiness that can be maintained for only a limited time should be used carefully if the military personnel strength is not one to be dissipated before the attack is developed. On the other hand Category A represents a condition in which the area is determined to be free from attack. However it is possible that an isolated enemy raid may be made on installation that would throw the Harbor Defense or armament concerned into condition one.

To illustrate. If an enemy force in strength should be operating in the waters off Greenland, having occupied Iceland as a base, the Eastern Seaboard would no doubt be thrown into Category E but at the same time no defense would necessarily be put in Condition one. However no harbor Defense would be any less prepared for action than demanded by Condition Two. In this case Condition one would not be established until the enemy force in question had developed its attack to the point that its fleet was committed to action against the defenses so alerted. In the other case, with a coastline declared free from attack and in Condition A, as in the case for the Eastern Seaboard in 1944, enemy submarines, or a raider disguised as a merchantman, would surely throw a harbor defense into Condition One if they appeared in a harbor entrance.

\*\*\*\*\*

\*\*\*\*\*

CATEGORIES OF DEFENSE  
(Abstracted from Joint Action, Army - Navy - 1935)

Category A - Coastal frontiers that probably will be free from attack, but for which a nominal defense must be provided for political reasons in sufficient strength to repel raids by submarines by surface vessels operating by stealth or stratagem, or isolated raids by aircraft operating chiefly for morale effect.

Category B - Coastal frontiers (sea frontiers and defense commands) that may be subject to minor attacks.

Category C - Coastal frontiers that in all probability will be subject to minor attack. Under this category, the coastal defense area should be provided, in general, with the means of defense, both Army and Navy, required to meet the following enemy naval operations: those incident to controlling the sea; those against shipping; and minor attacks against land areas. The harbor defenses should be fully manned and air support arranged. Long range air reconnaissance will be provided if practicable. If sufficient forces are available, outposts will be established outside of harbor defenses along the sensitive areas of the shore line. The inner mine barracks will, in general, be established; a full inshore patrol and complete control of shipping will, as a rule, be instituted; and certain outer mine barrages and defensive sea areas may be established, and a limited offshore patrol instituted.

Category D - Coastal frontiers that may be subject to major attack. Under this category, the coastal defense areas should, in general, be provided with the means of defense, both Army and Navy, required to meet enemy naval operations preliminary to joint operations. All available means of defense will generally find application, and a stronger outpost and a more extensive patrol, inshore and offshore, than for Category C, will be required. Under this category certain defensive sea areas and maritime control areas will be established. In addition, an anti-aircraft gun and machine-gun defense of important areas outside of harbor defenses should be organized; general reserves should be strategically located so as to facilitate prompt reinforcement of the frontiers; and plans should be developed for the defense of specific areas likely to become theaters of operations. Long range air reconnaissance will be provided and plans made for use of the GHQ air force.

Category E - Coastal frontiers that in all probability will be subject to major attack. Under this category, in addition to the measures required for Category D, there will be required generally the concentration of the troops necessary to defend the area against a serious attack in force together with additional naval forces to provide intensive inshore and offshore patrols. Defensive sea areas and maritime control areas will be established. Air defense will be provided as in Category D. All or a part of the GHQ air force may be ordered to the threatened area to operate either under direct control or Army GHQ or under that of the Army commander of the theater of operations or frontier.

Category F - Possessions beyond the continental limits of the United States which may be subject to either minor or major attack for the purpose of occupation, but which cannot be provided with adequate defense forces. Under this category, the employment of existing local forces and local facilities will be confined principally to the demolition of those things it is desirable to prevent falling into enemy hands.

## CATEGORIES OF DEFENSE

(from TM No. 18, Hq Second Coast Artillery Dist. Gen. Williford, Commanding,  
June 7, 1941.)

Condition One. This is the state of maximum readiness for action. In harbor defenses, all stations, communications and armament are manned in accordance with existing plans; antiaircraft troops will similarly man observation posts and communications, and hold gun and searchlights crews at or in the immediate vicinity of their armament; supporting infantry will maintain observation and patrol elements in accordance with plans, and will hold reserves in readiness. Artillery units cannot continue on CONDITION ONE indefinitely with available personnel; hence CONDITION ONE will be ordered for brief periods only, in general not exceeding six hours in any one day. When this condition is ordered on initial activation, immediate readiness for action will be the first objective. The movement of supply elements, and the set-up of messes and camps will be secondary.

Condition Two. This is the status of readiness which can be maintained indefinitely. Harbor defense and antiaircraft artillery observation stations and communications will be manned continuously, if necessary with reduced personnel or in reduced amounts, but not fewer than one station per battery. Command posts of all echelons will be operated continuously, with sufficient personnel for current requirements. Armament, equipment and personnel not actually at battle stations will be kept in such readiness that CONDITION ONE may be taken up within three minutes during daylight hours, and within five minutes during darkness.

Condition Three. This is the status of minimum readiness appropriate to war or emergency conditions. Not fewer than one secondary battery in each groupment of harbor defenses, and one major caliber battery in each harbor defense, with the necessary searchlights, will be maintained in CONDITION TWO; not fewer than half of the total number of antiaircraft batteries, both fixed and mobile, will be maintained in CONDITION TWO; at least one additional observation station per groupment will maintain continuous observation, harbor entrance control posts will be operated continuously, and communications will be manned at command posts down to groupments and antiaircraft regiments. The remaining armament and personnel off duty will be able to assume CONDITION ONE within one hour.

Classes of Materiel  
(Abstracted from TM 4-245)

Classification. - As a minimum, there will be designated as Class A one complete battery, or one complete unit or submarine mine material, together with accessories ..... to render it effective as a combat unit, for each lettered battery organization in each active harbor defense. The initial classification of seacoast batteries in the continental United States is prescribed by the War Department in harbor defense projects. The defense commander concerned is authorized to raise the classification of a battery from B or C to A by assigning the material to an organization primarily for the purpose of training or mobilization. Likewise, the same authorities may return batteries to a classification not lower than that prescribed by the War Department.

Class A \* - Materiel assigned to an organization in a primary capacity for purposes of regular and frequent training, together with all installations required to make that materiel effective, is considered as in class A. This materiel will be maintained at all times in such condition as to permit of its being prepared for service by a full strength manning party in not to exceed 24 hours.

Class B. - Materiel which is not assigned to an organization for frequent and regular training but which is important to the performance of the mission of a harbor defense is considered as in class B. For this class the maintenance year is divided into two periods which will be known as the "active" and "inactive" seasons. The "active" season will extend for a period of approximately 6 months, to be designated by the defense or department commanders; while the "inactive" period will extend throughout the remainder of the year. During the "active" season, all materiel will be placed in operating condition, fully assembled (with some exceptions) and will be maintained in such condition as to permit of its being prepared for service by a full strength manning party in not to exceed 24 hours. During the inactive season, materiel will be maintained ---- in such manner as to permit of its being prepared for service by a full strength manning party in not to exceed 72 hours.

Class C. - Materiel which is not assigned to an organization for regular or frequent training, and which is not considered vital to the performance of the mission of a harbor defense, but which is capable of furnishing some fir support, is regarded as in class C. Maintenance of this class will ordinarily be such that more than 72 hours will be required to restore the armament fully to an active condition. Such restoration, however, normally should be accomplished by a full strength manning party in less than 15 days.

---

\* NOTE. Instructions for the care and preservation of Class A materiel found in following publications: - Seacoast Artillery - Chapter 6, FM 4-20. Anti-aircraft Artillery - chapter 5, FM 4-120. (Ref. TM 4-245)







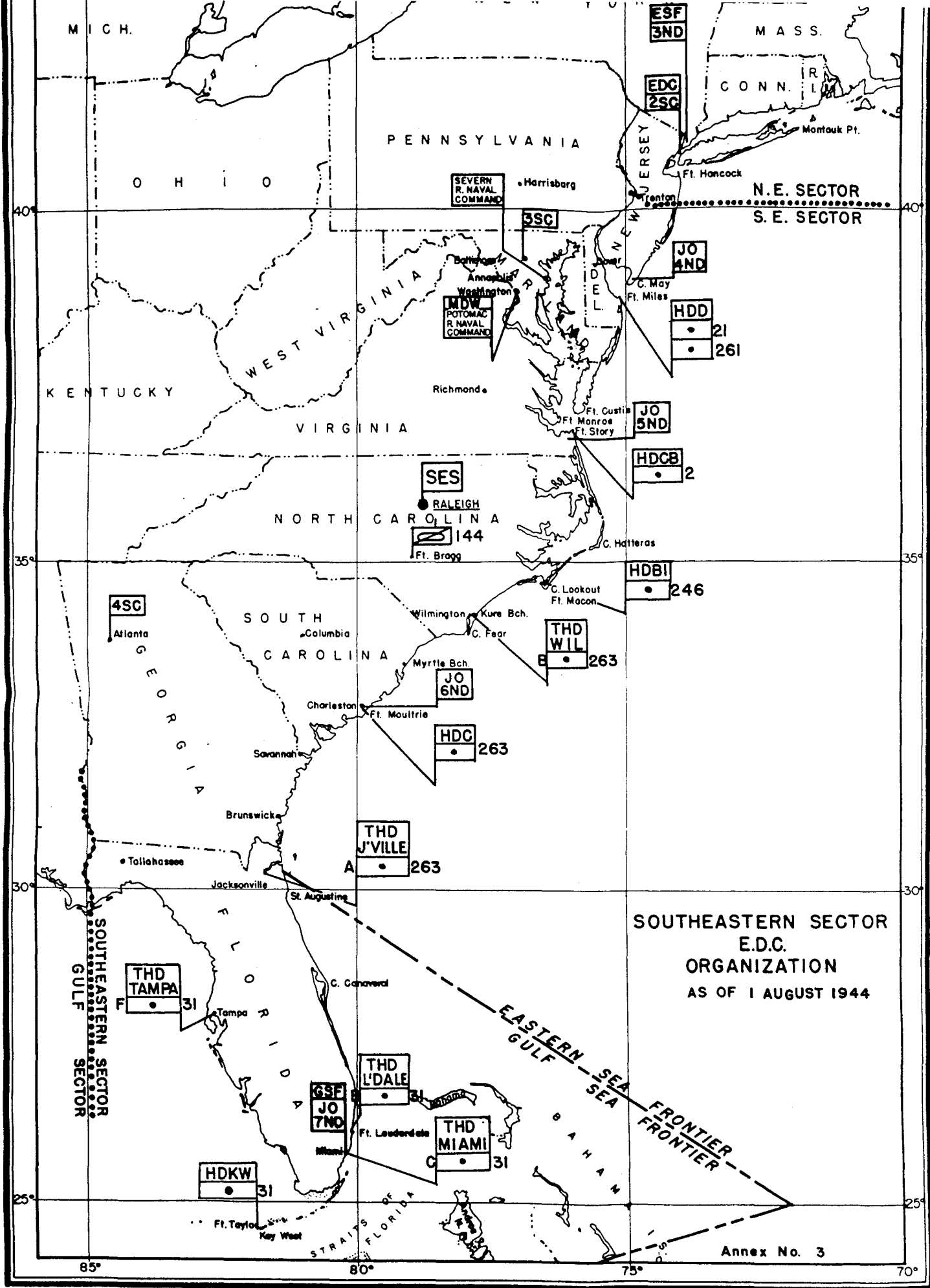

**SOUTHEASTERN SECTOR  
E.D.C.  
ORGANIZATION  
AS OF 1 AUGUST 1944**

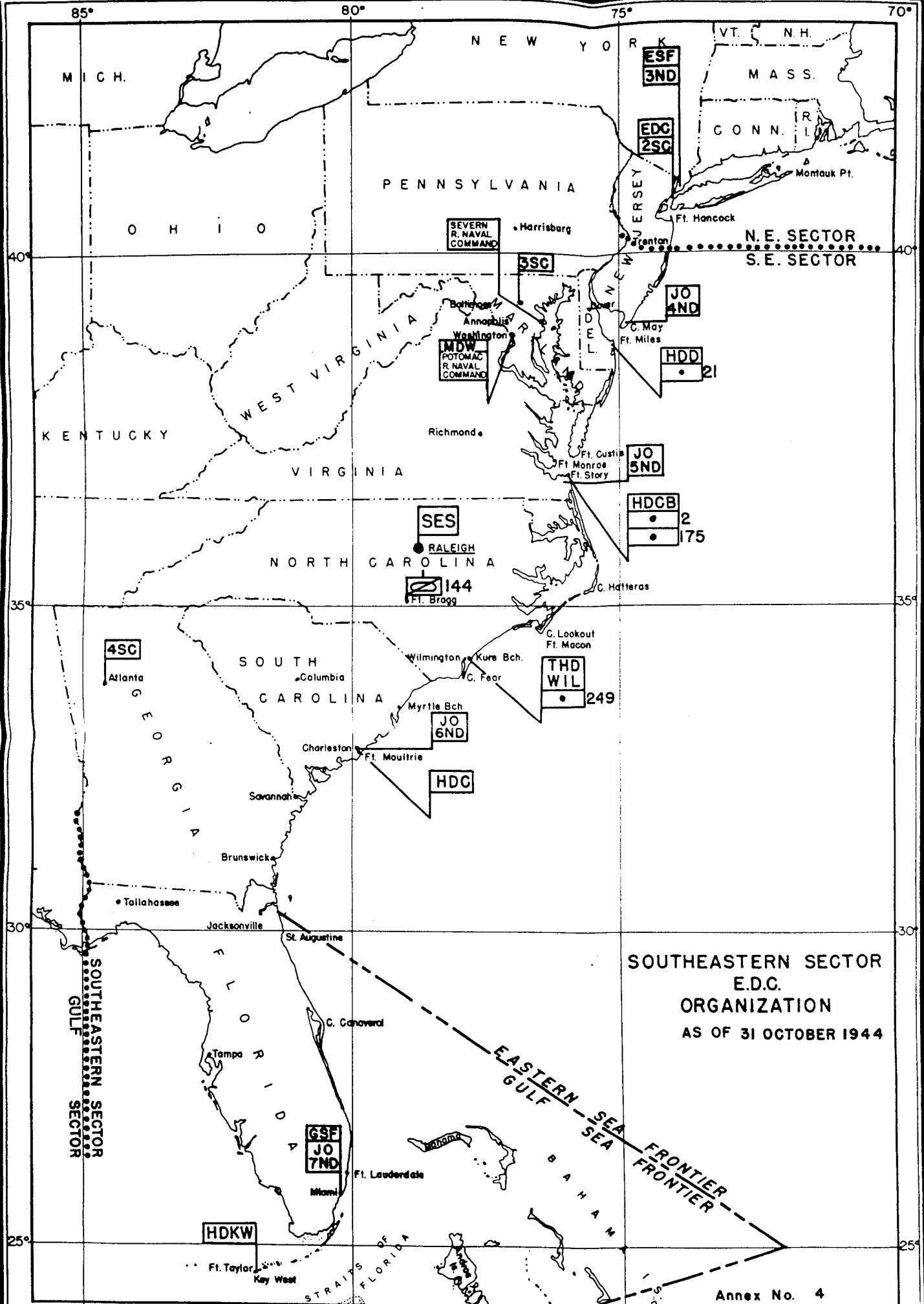

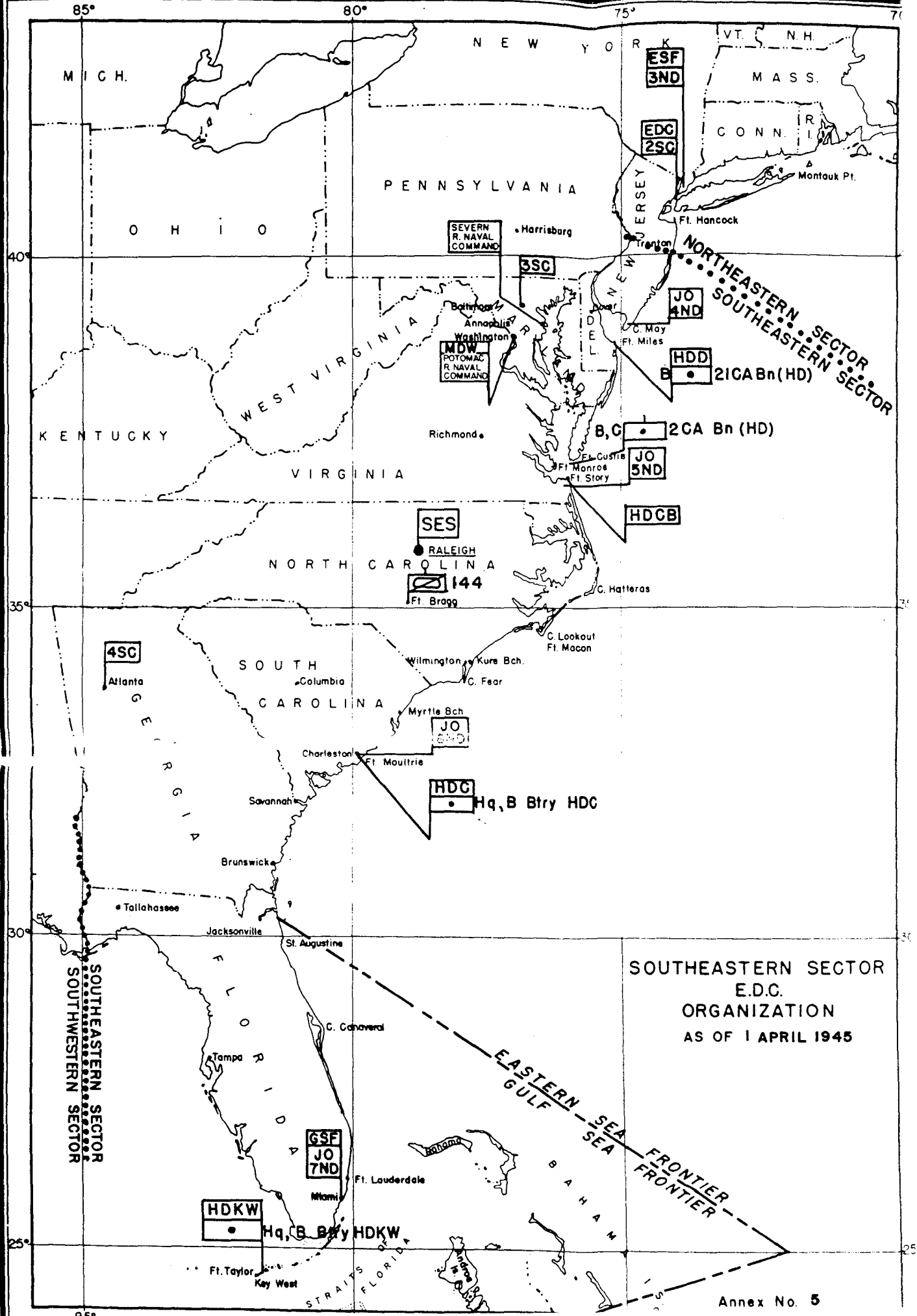

SOUTHEASTERN SECTOR  
 E.D.C.  
 ORGANIZATION  
 AS OF 1 APRIL 1945