Cape Lookout National Seashore

Portsmouth Life- Saving Station

Historic Structure Report



2006

Historical Architecture, Cultural Resources Division

Southeast Regional Office

National Park Service

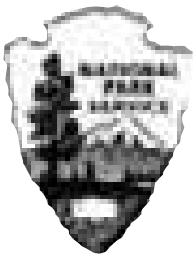

The historic structure report presented here exists in two formats. A traditional, printed version is available for study at the park, the Southeastern Regional Office of the NPS (SERO), and at a variety of other repositories. For more widespread access, the historic structure report also exists in a web-based format through ParkNet, the website of the National Park Service. Please visit www.nps.gov for more information.

**Cultural Resources
Southeast Region
National Park Service
100 Alabama St. SW
Atlanta, GA 30303
(404) 562-3117**

2005
Historic Structure Report
Portsmouth Life- Saving Station
Cape Lookout National Seashore
Portsmouth, NC
LCS#: 012512

Cover image: Portsmouth Life- Saving Station, c.
1910 (CALO Coll. c- 13)

Cape Lookout National Seashore

Portsmouth Life-Saving Station

Historic Structure Report

Approved by: _____

Superintendent

Date

Cape Lookout National Seashore

Recommended by: _____

Chief, Cultural Resources

Date

Southeast Regional Office

Recommended by: _____

Associate Regional Director

Date

Cultural Resource Stewardship & Partnership

Southeast Regional Office

Approved by: _____

Regional Director

Date

Southeast Regional Office

Table of Contents

Foreword	ix
Project Team	xi
Management Summary	
Historical Data	1
Architectural Data	1
Administrative Data	2
Locational Data	2
Related Studies	2
Cultural Resource Data	3
Historical Background and Context	
U. S. Life-Saving Service	5
Origins	6
Architecture	8
Technology to the Rescue	10
United States Coast Guard	13
Portsmouth	14
Portsmouth Life-Saving Station	17
The Station House	18
Outbuildings	19
Personnel	22
Patrols and Rescue	24
Community Relations	26
Security and Law Enforcement	27
Chronology of Development and Use	
Original Construction	29
Site	29
Original Plan	32
Original Exterior Finishes	34
Original Interior Finishes	36
Other Original Interior Features	36
Lighting	36
Water	36
Heating	36
Maintenance	37
Painting	37
Gutters	37
Screens	38
Flooding	38
Alterations	39
Documentation	39
1895-1915	40
1915-1946	40

Physical Description

Associated Site Features	54
Masonry	55
Boat Ramps	55
Chimney	56
Cistern	56
Foundation	57
Structure	57
Exterior Finishes	58
Porch	59
Windows	60
Doors	62
Entrance Doors	62
Boat Room Doors	63
Interior	65
Room 100 (Hall)	68
Room 101 (Pantry/Bathroom)	68
Room 102 (Kitchen/Office)	69
Room 103 (Storm Clothes Room)	71
Room 104 (Mess Room)	73
Room 105 (Stair Hall)	76
Room 106 (Keeper's Room)	78
Room 107 (Boat Room)	80
Room 200 (Stair Hall)	83
Room 201 (Crew Quarters)	85
Room 202 (Spare Room)	87
Room 203 (Store Room)	89
Attic	90
Watch Room	91
Plans of Existing Building	95
Site Plan	95
First Floor Plan	97
Second Floor Plan	99
Attic Floor Plan	101
Watch Room and Roof Plan	103
Molding Profiles	105

Treatment and Use

Requirements for Treatment and Use	107
Alternatives for Treatment and Use	108
Use	109
Treatment	109
Ultimate Treatment and Use	110
Use	110
Treatment	110

Sources of Information

Published Sources	111
Historic Drawings	111
Historic Photographs	112

Appendix A

Historic Drawings	113
-------------------	-----

"Plat of U. S. Marine Hospital Reservation at Portsmouth, NC" July 7, 1893.	115
"Position Plan for Buildings of the U. S. Life-Saving Station at Portsmouth, NC," N.D., probably 1894.	117
"Fence for the Portsmouth, N.C. Life-Saving Station" N.D., probably 1894.	119
"[Plot of]U. S. Life-Saving Station in Portsmouth, N. C.," December 17, 1900.	121
"Plot of Lot of U.S. L-S.S., Portsmouth, N. C., 7th Dist.," June, 1903, revised July 26, 1909.	123
"Harbor and Proposed Location for Wharf," March 1913.	125
"Sketches for Boathouse Showing Basin Hoisting Gear and Boat in House," April 1913	127
	128
"Details of Walk and Wharf, and Profile Showing Ground and Wharf Elevations," April 1913.	129
"End Section of Concrete Sheet Piles," July 9, 1914.	131
"Drawing of Walk," April 3, 1916.	133
"Portsmouth Station" [plans of first and second floors], N. D., probably 1916.	135

Appendix B

Specifications for Brant Rock Life-Saving Station	137
---	-----

Appendix C

Portsmouth Life-Saving Station Log Books, 1894-1937	159
---	-----

Foreword

We are pleased to make available this historic structure report, part of our ongoing effort to provide comprehensive documentation for the historic structures and landscapes of National Park Service units in the Southeast Region. A number of individuals contributed to the successful completion of this work, but we would particularly like to thank the staff at Cape Lookout National Seashore for their assistance throughout the process. Special thanks to Superintendent Bob Vogel, Michael Rikard, Mike McGee, Dave Frum, and Karen Duggan. We hope that this study of the Portsmouth Life- Saving Station will prove valuable to park management in ongoing efforts to preserve the building and to everyone in understanding and interpreting this unique resource.

Dan Scheidt, Chief
Cultural Resources Division
Southeast Regional Office
June 2006

Project Team

Project Manager

Danny Scheidt, Historical Architect
National Park Service
Southeast Regional Office
Atlanta, GA

Primary Research, Building Investigation, and Author

Tommy H. Jones, Architectural Historian
National Park Service
Southeast Regional Office
Atlanta, GA

*Document Publication/
Intranet Access*

Jay Womack, Historian
National Park Service
Southeast Regional Office
Atlanta, GA

Program Reviews

Bob Blythe, History
Allen Bohnert, Curatorial & Museum Services
Danny Scheidt, Historical Architecture
National Park Service
Tracy Stakely, Historical Landscape Architecture
Southeast Regional Office
Atlanta, GA

Management Summary

The largest building in Portsmouth, the Life- Saving Station has been a landmark on the island for over a century. It is the best- preserved example of some twenty- one “Quonochontaug” stations that the Life- Saving Service built along the eastern seaboard between 1891 and 1904, only ten of which survive today.

Historical Data

The present report drew upon the park’s large collection of historic photographs of the Portsmouth Life- Saving Station, beginning about 1910, and on the station log books, which were kept continuously from 1894 until 1937 and are now at the Atlanta branch of the National Archives and Records Administration (NARA). In addition, nine historic architectural drawings were located at NARA’s Philadelphia facility and at their cartographic division in College Park, Maryland. Copies of these historic drawings and an abstract of the station’s log books can be found in the appendices to this report.

Located in the uninhabited village of Portsmouth, North Carolina, on the south side of Ocracoke Inlet, the Portsmouth Life- Saving Station was constructed in 1894 as part of a chain of stations that the United States Life- Saving Service established along the nation’s coastlines in the last quarter of the nineteenth century. Technological advances in the early twentieth century reduced the need for the Life- Saving Service, and in 1915, it was merged with the United States Merchant Marine to form the United States Coast Guard.

The Coast Guard continued the work of the Life- Saving Service, but as part of the country’s military establishment the Coast Guard also played a major

role in defense and in control of the nation’s coasts against smuggling and illegal immigration. In 1937, the Coast Guard decommissioned the Portsmouth station as part of a consolidation of resources, although it was re- activated for a brief period during World War II. Used as a hunting club after the war, the building was once again returned to government ownership after authorization of the the Cape Lookout National Seashore in 1966.

Architectural Data

Constructed in 1894 with only slight modifications to a standardized, Shingle- Style design and plan by Life- Saving Service architect George R. Tolman, the Portsmouth Life- Saving Station is one of only ten Quonochontaug- type stations remaining in existence and the only one that has not undergone major modifications. There is no physical evidence in the present building to suggest any changes to the original floor plan, except for installation of the gun closet in Room 101 and of the lightweight partition in Room 103 and closure of the door opening between Rooms 102 and 104. In addition, most alterations to the station, including replacement of the original plaster walls and ceilings and the original door hardware occurred during the historic period.

The station flooded on several occasions, necessitating repairs to the plaster walls as early as 1904. Two wash rooms were created in 1908, but a privy remained a fixture at the station as late as the 1940s. The original lock sets, knobs, and escutcheon plates at all interior doors were replaced in 1913, although all of the original doors remain intact. There has probably been some replacement of window sash due to storm damage, but the original six- over- two muntin pattern has not been

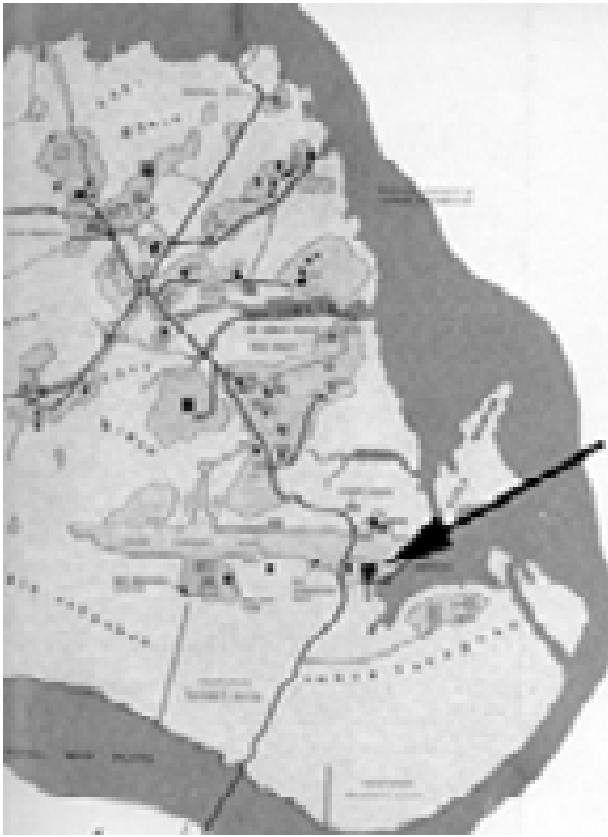

FIGURE 1. Map of Portsmouth, NC, with arrow indicating location of Life-Saving Station.

changed. Nearly all of the original plaster was replaced, probably when the station was reactivated during World War II, but it was never wired for electricity. The NPS added a shower in Room 102 but later removed all plumbing fixtures from the building. The cedar- shingle siding and roofing were completely replaced in 1978.

Although it has apparently not been occupied on a year- round basis since the end of World War II, the station has always been used primarily as a residence. Only the boat room did not serve that residential function, historically being used for storage and maintenance of the station's boats or, as in recent years, for the storage and maintenance of lawn tractors and other landscape equipment.

Treatment and Use

Unlike most of the other structures at Portsmouth, which are simple vernacular buildings, the old Life-Saving Station is a significant example of historic architecture, designed and later modified by the

government for specific uses. It is the best-preserved of the few life- saving stations of this type that remain along the East Coast and has the potential to be the centerpiece of the park's interpretation of the United States Life- Saving Service and Coast Guard as well as a major point of interpretation of the village of Portsmouth itself.

The park is presently planning presentation of the building as a museum to exhibit both the building's architecture and its use as a life- saving station. The historical significance of the Life- Saving Station and the quality and scale of its architecture insures a high level of public interest in the building. Because of the building's architectural significance, the few unsympathetic alterations to the building that occurred after World War II should be reversed. The interior of the building should be repaired as necessary and preserved in more- or- less its present condition. Much of this work is presently underway as part of repair of hurricane damage that has occurred over the last five or six years.

Administrative Data

Locational Data

Building Name: Portsmouth Life- Saving Station

Location: Portsmouth, North Carolina

LCS Number: 012512

Related Studies

Burke, Kenneth E. "The History of Portsmouth, North Carolina, From Its Founding in 1753 to Its Evacuation in the Face of Federal Forces in 1861." Unpublished undergraduate thesis, University of Richmond, Richmond, Virginia, 1958. Revised 1974, 1976.

Denver Service Center. General Management Plan/ Development Concept Plan, Cape Lookout National Seashore. December 1982.

Ehrenhard, John E. Cape Lookout National Seashore: Assessment of Archeological and Historical Resources. SEAC, NPS, 1976.

Holland, F. Ross. A Survey History of Cape Lookout National Seashore. Department of History,

Office of Archeology and Historic Preservation,
NPS, 1968.

Cape Lookout National Seashore, "Portsmouth
Village, Historic Structures Management
Recommendations," August 1984.

Olson, Sarah. Historic Resource Study, Portsmouth
Village, Cape Lookout National Seashore,
North Carolina. NPS- DSC, 1982.

Van Beck, Sara L. Cape Lookout National Seashore,
Archives and Records Management Review.
NPS, 2000.

Cultural Resource Data

National Register of Historic Places: Contributing
structure in Portsmouth Village Historic District,
listed Nov. 1979

Period of Significance: 1890- 1930

Proposed Treatment: Preservation

Historical Background and Context

Located in the uninhabited village of Portsmouth, North Carolina, on the southwest side of Ocracoke Inlet, the Portsmouth Life-Saving Station was constructed in 1894 as part of a chain of stations that the United States Life-Saving Service established along the nation's coasts in the last quarter of the nineteenth century. Technological advances in the early twentieth century reduced the need for the Life-Saving Service, and in 1915, it was merged with the United States Revenue Cutter Service to form the United States Coast Guard. The Coast Guard continued the work of the Life-Saving Service, but as part of the country's military establishment also played a major role in defense and in control of the nation's coasts against smuggling and illegal immigration. In 1937, the Coast Guard decommissioned

the Portsmouth station as part of a consolidation of its resources, although the station was re-activated for a brief period during World War II. Used as a hunting club after the war, the building was once again returned to government ownership after authorization of the Cape Lookout National Seashore in 1966.

U. S. Life-Saving Service

As shipping increased along the Atlantic seaboard after the American Revolution, so too did maritime disasters and resultant loss of life. While north-bound shipping generally took advantage of the



FIGURE 2. Detail from Henry Mouzon's "An Accurate Map of North and South Carolina, 1775," showing part of the Outer Banks, with Portsmouth on the south side of Ocracoke Inlet just right of center in this view. (North Carolina Department of Archives and History)

Historical Background & Context

powerful Gulf Stream, which kept them well away from the shoals and hazards along the Outer Banks, southbound shipping did not have that option and, especially when weather conditions were bad, often foundered in the treacherous waters off the Outer Banks. Ocracoke Inlet, which is the only one of the several inlets to Pamlico Sound that has remained continuously open throughout the historic period, offered its own hazards with shifting shoals and channels bringing disaster to many unwary pilots.

The federal government began to establish lighthouses and light stations as early as the 1790s, and a lighthouse was in operation on Shell Island at Ocracoke Inlet in 1797. By 1803, a lighthouse was also in operation at Cape Hatteras, and in 1823, a lighthouse at Ocracoke replaced the old Shell Island beacon, which had been struck by lightning and burned in 1818. In spite of these efforts, the sea continued to take a dreadful toll as sailing vessels were routinely blown onto the shoals and broken to pieces by the waves. Any crew that did not drown with the wreckage had little hope of escaping death from exposure once they reached what were, even in New England, sparsely-populated shores.



FIGURE 3. Sumner Increase Kimball (1834-1923), general superintendent of the United States Life-Saving Service. (CALO Coll.)

The Massachusetts Humane Society established the first "Huts of Refuge" along the Massachusetts shore in 1787, providing shelter at least for shipwrecked sailors. In 1807 they began to equip some of these shelters with boats and equipment that could be used by volunteers to make rescues at sea. Other volunteer organizations sprang up, but these were generally limited to areas around busy ports, especially the Long Island and New Jersey approaches to the harbor at New York. In any case, volunteers could provide help but to a few of the dozens of ships that wrecked along the Atlantic seaboard each year.¹

Origins

The origins of the federal government's Life-Saving Service can be traced to August 14, 1848, when Congress passed the Newell Act and appropriated \$10,000 for "surf boats, rockets, carronades and other necessary apparatus for the better preservation of life and property from shipwrecks" along the New Jersey shore. Eight lifeboat stations were built and equipped, and in 1849 additional appropriations allowed construction of fourteen stations on the shores of New Jersey and Long Island.

In 1850, a station was established in Rhode Island, and lifeboats and boat houses (but no live-saving stations) were also funded (but apparently never built) for the shores of the Carolinas, Georgia, Florida, and Texas. Administered by the Treasury Department's Revenue Marine Division (later the Revenue Cutter Service), the Life-Saving Service was perennially underfunded, and equipment and stations that were in place frequently fell into disrepair.

The loss of over two hundred lives in the wreck of the *Powhattan* off the New Jersey shore on April 16, 1854, spurred a Congressional investigation. Especially troublesome was the news that many of the bodies that washed ashore had been robbed by "shore villains," and the government had "no provision to prevent such depredations."² The wreck of the *New Era* at Deals Beach, New Jersey, in Novem-

1. The U.S. Coast Guard's web site at http://www.uscg.millhlg-cpl/history/h_USLSS.html provides a comprehensive history of the Life-Saving Service.
2. Means, Dennis R. "A Heavy Sea Running: The Formation of the U.S. Life-Saving Service, 1846-1878." *Prologue: Journal of the National Archives*, Winter 1987, Vol. 19, #4.

ber 1854 claimed another 230 lives and sparked additional support for an effective Life-Saving Service; but it was not until 1857 that appropriations were made to begin implementation of the recommendations from the Congressional investigation in 1854. Full-time station keepers were hired for the first time, but their effectiveness was often limited by the difficulty in rounding up a volunteer crew when an emergency arose.

Another series of disasters in the winter of 1870-71 exposed the sorry state of the life-saving service after years of neglect during the Civil War. In February 1871, responding to renewed calls for reform, the Treasury Department appointed a new director, Sumner Increase Kimball, for the department's Revenue Marine Division, which included the Life-Saving Service. Kimball, a young lawyer from Maine, promptly began a complete evaluation of the system of life-saving stations. Based upon his report, Congress appropriated \$200,000 to employ life-saving crews and build new stations. New regulations and standards were established by Kimball, professionalizing the system and dramatically increasing its effectiveness.

The system of life-saving stations was greatly expanded in the early 1870s, with twenty-three new stations built in 1874 alone, including stations on the Outer Banks of North Carolina at Currituck Beach, Caffey's Inlet, Kitty Hawk, Nags Head, Bodie Island (located south of Oregon Inlet and later renamed for the inlet)³, Little Kinnakeet, and Chicamacomico.⁴ Nonetheless, the recommended three-mile distance between stations was not yet achieved, especially along the isolated, southern reaches of the Outer Banks.

On November 24, 1877, the *Huron* ran aground and broke up off Nags Head, claiming ninety-eight lives. Then, on January 31, 1878, with the hue and cry over that disaster barely past, the *Metropolis* went down, taking with her another eighty-five lives. Worse yet, the crew at the closest station was slow to notice the wreck and, when they finally did, botched the rescue. These disasters provoked another round of recriminations, and a bill was even introduced in

Congress that would remove the Life-Saving Service from the jurisdiction of Kimball and the Treasury Department altogether. Support for Kimball was strong, however, and the move failed. Instead House Resolution 3988 was passed on June 17, 1878, and signed into law by President Hayes the following day, formally establishing the Life-Saving Service as a separate agency within the Treasury Department. Sumner Kimball was named general

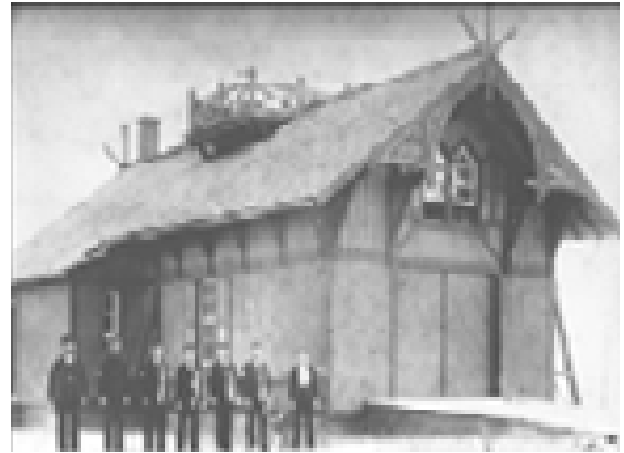

FIGURE 4. View of Little Kinnakeet Life-Saving Station, typical of the first generation of architect-designed stations built by the Life-Saving Service in 1874. (U. S. Coast Guard Coll.)



FIGURE 5. The Kill Devil Hills Life-Saving Station around 1903. (Library of Congress)

3. The original station on Bodie Island north of Oregon Inlet was called Tommy's Hummock.
4. Richard L. Chenery III, *Old Coast Guard Stations, Volume II, North Carolina* (Station Books, 2000).

Historical Background & Context

superintendent, a post he would hold as long as the Life- Saving Service existed.

The 1878 Act that created the Life- Saving Service also included authorization for thirty new life- saving and life- boat stations, including fifteen new stations on the coasts of Virginia and North Carolina. Eleven stations went up along the Outer Banks at Wash Woods, Penny's Hill, Poyner's Hill, Paul Gamiel's Hill, Kill Devil Hills, Tommy's Hummock (later renamed Bodie Island), Pea Island, Gull Shoal, Big Kinnakeet, Creed's Hill, and at Hatteras (later called Durants). In 1881, a station was built at Cape Fear, and the following year, new stations were constructed at New Inlet, Cape Hatteras, Hatteras Inlet, and on Ocracoke Island three miles northeast of Ocracoke Inlet.

Like so much else with the Life- Saving Service, however, full appropriations to construct new stations at the recommended intervals were slow to be made, and not until 1886 was a station built at Cape Lookout, the first station along the forty- mile length of Core Banks south of Ocracoke Inlet. In 1894, a life- saving station opened at Portsmouth at the north end of Core Banks, and the following year, a station opened about half- way between Portsmouth and Cape Lookout. Called Core Banks Sta-

tion (later Atlantic Station), it was the last station built on Core Banks but still left the three stations with many miles of shoreline to patrol.

While life- saving remained the primary mission of the Life- Saving Service, the distribution of the stations along the nation's shorelines led to military use of the Life- Saving Service during the Spanish- American War. In 1898, the Navy's need to patrol the coasts prompted the department to assign the coast watching mission to the Life- Saving Service. As a result, two- thirds of the Navy's coastal observation stations along the coastline of the U.S. were life- saving stations. Although the Spanish fleet was never observed along the nation's coasts, the Life- Saving Service's role in that endeavor was a precedent for military operations by the Service's successor, the United States Coast Guard.

Architecture

The Construction Branch of the Department of the Treasury was responsible for construction of the Life- Saving Service's new stations and, after 1874, generally employed architects who produced standard plans and designs that were typically used for construction of several stations.⁵ Francis W. Chandler produced some of the earliest professionally designed stations in 1874, but J. L. Parkinson was the



FIGURE 6. View of Cape Lookout Life-Saving Station about 1890, designed by J. L. Parkinson and built in 1887. (CALO Coll. G-09)

first architect employed directly by the Life- Saving Service, beginning in 1875. Several of the first stations along the Outer Banks, including the stations at Chicamacomico, Kinnakeet, Bodie Island, and Cape Lookout, owe their design to him. Parkinson apparently left the service around 1882, and a series of architects, including the famed McKim, Mead, and White, were contracted for station design until Albert B. Bibb was employed by the Life- Saving Service full time in 1885. Under his tenure, which ended in 1890, some 78 stations were constructed, but apparently none of them were on the Outer Banks.

George R. Tolman. Parkinson’s successor was George R. Tolman, who worked for the Life- Saving Service from 1891 until 1896 and was responsible for the design of the Portsmouth Life- Saving Station. Born in Dorchester,⁶ Massachusetts, in 1848, Tolman was the youngest child of Joseph A. and Elizabeth Tolman. The elder Tolman was a dry goods salesman of rather modest means whose wife died while George was still a teenager. George’s education has not been documented, but by 1870, he was working as a “draughtsman,” although where he was employed is not known. He was still living at home with his father, his older brother Albert, who was working as an architect, and his oldest sister Mary and her husband William Ulman.⁷

Sometime in the 1870s, George Tolman formed a partnership with George F. Moffette and, as Moffette and Tolman, designed a number of Boston residences and commercial buildings. Tolman was also noted for his water colors and for his illustrations for the Rev. Edward G. Porter’s *Rambles in Old Boston, New England*, published in Boston in 1887. During the same period, Tolman’s brother Albert went to work as an architect for the United States Treasury Department, and it was probably that connection that brought George Tolman into the employment of the Life- Saving Service in 1891.

Tolman’s first design for the Life- Saving Service was a Shingle- Style building for a station at Quonochontaug, Rhode Island, constructed in 1891 (Figure 7). Over the next ten years, twenty- one buildings would be built to the similar design, including the stations at Portsmouth, Currituck, Caffey’s Inlet, Oregon Inlet, and Core Bank on North Carolina’s Outer Banks. A modified version of the design, which included a cross- gabled roof, was also used for the Life- Saving Service’s exhibit at the World’s Columbian Exposition in 1893.

The original Quonochontaug station was destroyed in the great hurricane of 1938, and all but eight other stations of this type have been destroyed as well, including the Core Bank station which burned in the 1970s. At least two of the surviving Quonochontaug stations- - Virginia Beach and Oregon Inlet- -



FIGURE 7. Tolman’s station at Quonochontaug, Rhode Island, the prototype for the Portsmouth station. (From York, *Architecture of the United States Life-Saving Service*)



FIGURE 8. View of Core Bank Life-Saving Station prior to its expansion and remodeling in 1934. Note the stone foundation, which the Portsmouth station did not have. (CALO Coll.)

5. Unless otherwise noted, information about the architecture of the Life-Saving Service is taken from Eugene York, “The Architecture of the United States Life-Saving Service” (Boston University, unpublished undergraduate thesis, 1972) and from Shanks, et.al., *The U. S. Life-Saving Service* (Petaluma, CA: Costano Books, 1996).
6. Dorchester was annexed by the City of Boston in 1870.
7. U. S. Federal Census, 1850-1870.

Historical Background & Context

were altered after World War I by the addition of square watch towers set on the side of the building. (The Core Bank station underwent similar alterations.) Three Quonochontaug-type stations have been adapted as residences, one of which was on the market for over a million dollars in the late 1990s, and three others have been adapted for commercial purposes. The abandoned Oregon Inlet station, which was altered in the 1930s, is in very poor condition. Only the Portsmouth station is well preserved, retaining most of its original features.

In July 1896, Tolman was dismissed from his position at the Life-Saving Service after he went absent without leave, apparently to escape incarceration for some unknown legal difficulties. His six-plus years at the service marked the shortest tenure of any of the Life-Saving Service's architects, but during that period Tolman designed at least forty-seven



FIGURE 9. Elevation for Tolman's design for a station at the World's Columbian Exposition. (Taken from York, "Architecture of the United States Life-Saving Service")

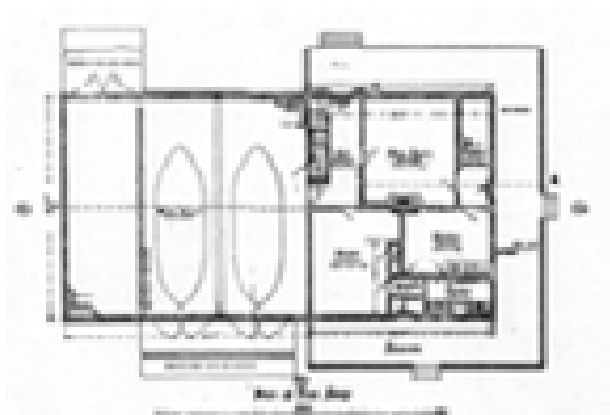

FIGURE 10. Tolman's plan for the station at the Columbian Exposition. (Taken from York, "Architecture of the United States Life-Saving Service")

new life-saving stations.⁸ His career after 1896 has not been documented, and he cannot be located in the Federal census until 1930, when he is shown living with his niece Mary Ullman and her family in Hingham, Massachusetts, not far from where he had been born eighty-two years earlier.⁹

Technology to the Rescue

In the late nineteenth and early twentieth centuries, there were tremendous technological advances that had a profound effect on the work of the Life-Saving Service. Not only did technology change the nature of the life-saver's work, technology changed the very need for the service as well.

Sailing vessels remained in common use into the twentieth century, but by the 1860s, steam-powered ships, with their greater carrying capacity and reliability, were rapidly replacing sailing vessels. Even the great clipper ships faced obsolescence with the opening of the Suez Canal in 1869. Steam power not only kept a ship moving in calm weather, but it also gave the captain greater control in stormy weather, making it less likely that the vessel would be blown on to shoals or the shore itself. Even so, a great "nor'easter"¹⁰ in March 1888 sent as many as 200 ships onto the shoals along the Atlantic seaboard.

Radio Communication. Even with the advantage of steam, however, there was still no way to determine positions at sea when the sky was overcast, and lighthouses served as only rough markers of location. However, advances in radio technology in the late nineteenth and early twentieth centuries allowed not only for better ship-to-shore communication but ultimately provided the technology for accurate positioning, regardless of weather conditions. These technological innovations fundamentally altered the Life-Saving Service's work.

Historically, communication between ship and shore depended entirely on visual contact, with

8. York, "Architecture of the United States Life-Saving Service,"; Shanks, et. al. *The U. S. Life-Saving Service*, pp. 233-237.
9. U. S. Federal Census, 1900-1930.
10. A "nor'easter" or "northeast storm" is a cyclonic storm that forms off the East Coast of North America, so called because the winds over the coastal area preceding the storm's passage are from the northeast. They may occur at any time of the year but are most frequent and most violent between September and April.

warnings against impending disaster limited to the use of flares and signal flags. The advent of battery-powered “occluding lights” in the early 1900s allowed life- saving stations to communicate through Morse code, not only with ships at sea but also with nearby stations. Nevertheless, visual contact was still necessary and even the station’s occluding light was virtually useless in foggy or stormy conditions.

Radio waves were first detected in 1887 by Heinrich Hertz, and in 1895 Guglielmo Marconi built the first radio transmitter, marking the birth of wireless communications. The technology’s utility in protecting shipping interests was readily apparent, and the first official naval radio message, using Morse code, was sent from ship to shore in 1899. By the early 1900s, all of the major shipping lines had on-board radio transmitters; but only after the *Titanic* disaster in April 1912 did ship- board radio transmitters become nearly universal, greatly reducing the isolation of ships during emergencies and bringing about an almost immediate reduction in the loss of lives from maritime disasters.¹¹

Reginald Fessenden, a Canadian- born inventor who had worked under Thomas Edison, is generally regarded as the “father” of modern radio, having made the first radio transmission of sound in December 1900. Early in 1901, working under contract for the U. S. Weather Bureau, he began construction of three signal stations at Manteo and Buxton on the Outer Banks and at Cape Henry, Virginia. Living at Manteo for a year and a half, he was able to fine tune his system of continuous- wave transmissions, leading to the first true radio broadcast on Christmas Eve 1906.¹²

The *Titanic* disaster gave Fessenden the impetus to perfect his submarine fathometer, an echo depth finder that was later known as SONAR (Sound Navigation and Ranging). In the years leading up to World War I, applications of the new radio technology proliferated, and in 1916, the Navy first used

radio telephones between ships. With the United States’ entry into the war in 1917, radio quickly became one of the military’s most important tools.

In addition, the need for a reliable means of locating the source of suspicious radio signals led the Navy to build on Fessenden’s work to create the “radio compass,” which utilized a system of triangulation to determine the origin of signals. The utility of the radio compass as an aid to navigation was quickly recognized, since the radio compass obviated the necessity for ships to guess at their location, whatever the weather or visibility. As Secretary of the Navy Josephus Daniels reported in 1919, “The system of radio compasses on shore . . . proved such a



FIGURE 12. An early motor boat on Lake Michigan, 1905. (*Chicago Daily News* negatives collection, DN-0003451. Courtesy of the Chicago Historical Society)



FIGURE 13. Surfmen from the Race Point Coast Guard Station wheeling their surfboat to the water. (Library of Congress, call # LC-USW38-002064-C)

11. “Important Events in Radiotelegraphy,” Dept. of Commerce, Bureau of Navigation, Radio Service, 1 February 1916, Government Printing Office, viewed on line at <<http://earlyradiohistory.us/1916impt.htm#safeguard>> on 31 May 2005.
12. Thomas Yocum, “Reginald Fessenden, Pioneer of Wireless Radio,” <www.coastalguide.com/bearings/wirekess01.htm>.

Historical Background & Context

useful aid to navigation that during the past year [nineteen] additional stations have been constructed."¹³

Motor Boats. The life- saving service utilized a variety of boats to accomplish its mission, and by the 1890s, most stations were equipped with at least two. "Surf boats" were small boats that were designed to be launched directly from the beach into heavy surf, and every station had at least one,

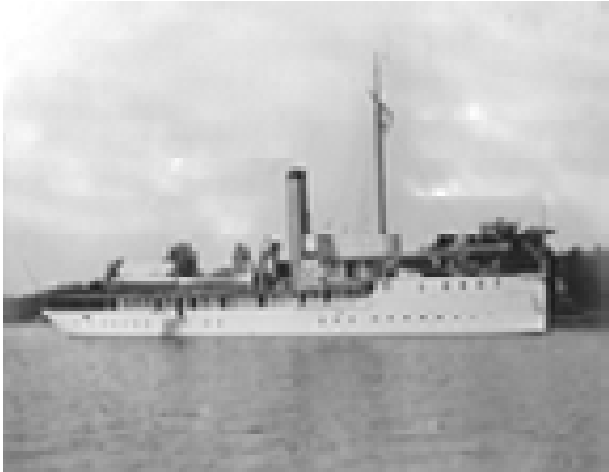

FIGURE 14. The Coast Guard cutter Pamlico, commissioned in 1907 and stationed in New Bern, for patrol of the sounds along the North Carolina coast, including the waters around Portsmouth. (U. S. Coast Guard collection, accessed at <http://www.uscg.mil/hq/g-cp/history/WEBCUTTERS/Pamlico_1907.html> November 18, 2005)



FIGURE 15. A Coast Guard speedboat on Lake Michigan, 1926, developed for enforcement of Prohibition. (Library of Congress, DN-0080877, Chicago Daily News negatives collection, Chicago Historical Society)

13. Viewed on line at <<http://www.multied.com/Navy/Tug/Adelante.html>> on 3 June 2003.

which would be hauled to the beach on a wagon drawn by horses or quite often by the surfmen themselves. The Monomoy surf boat, named after the Massachusetts town of the same name, evolved from double- ended whaling boats and could be rowed or sailed in virtually all conditions. Standardized at 26' long, 7' wide, and 2'- 4" deep, the boat could accommodate up to ten rowers and was one of the first boats at the Portsmouth Life- Saving Station. (Similar boats at the Kill Devil Hills and the Cape Lookout stations can be seen in Figures 5 and 6.)

The Beebe- McClellan surf boat, named after the two men who created it, was perhaps best- known. Developed for the government in 1879 and used at nearly all life- saving stations, these boats were advertised as self- righting and self- bailing and were known to be virtually unsinkable. About the same size as the Monomoy boat, the Beebe- McClellan could also be rowed or sailed.

The advent of gasoline- powered boats was a great boon to the Life- Saving Service, reducing the crew's isolation during the active season and dramatically easing the crew's work in responding to emergencies. In 1896, the American Motor Company produced the first outboard motor, but not until 1905 did Cameron B. Waterman become the first to produce a really affordable outboard motor. Although the government itself was slow to provide power boats to its life- saving stations, residents of the Outer Banks and similar areas were quick to adopt the new technology. By 1910, gasoline- powered boats had become so popular that Congress passed the Motorboat Act, giving the Revenue Cutter Service jurisdiction to regulate pleasure boating in the United States and assigning identification numbers to each craft.

While the owner of the first power boat at Portsmouth is not known, the Keeper himself had a "gas boat" as early as November 1904.¹⁴ The Life- Saving Station logs indicate that many, if not most, of the crew at Portsmouth and at other stations as well acquired gasoline- powered boats around the same time.¹⁵ The Life- Saving Station logs also document

14. November 22, 1904, Station Log of the Portsmouth Life-Saving Station, original documents at National Archives and Record Center in Morrow, GA, hereinafter referred to as "Station Log."

that the Life- Saving Service delivered a gasoline-powered boat to the Cape Lookout station in the fall of 1909, but the Portsmouth station appears not to have gotten its own power boat until February 1912.¹⁶

United States Coast Guard

The Life- Saving Service was perennially underfunded, with no retirement system and certainly no compensation for injured crew. More importantly, salaries remained so low that it was difficult to hire new recruits. Kimball had long recognized these problems, but not until the eve of World War I was there enough support to finally act on his proposals. On May 26, 1913, Senate Bill #2337 was introduced to combine the Life- Saving Service and the Revenue Cutter Service into a single entity, to be called the United States Coast Guard. Signed into law by President Wilson on January 28, 1915, the bill not only combined the two services but also provided for the retirement of Kimball and many of the older keepers and surfmen, something Kimball had advocated for years.

After forty- four years of service, Kimball could be proud of what he had almost single- handedly

15. See Station Logs for the Cape Lookout and the Bodie Island Life-Saving Stations.

16. Station Log, February 6 and 15, 1912.

brought into being. During that period, 28,121 ships and 178,741 people had benefitted from Life- Saving Service rescue missions, and the death toll where stations were in existence was limited to 1,455 during the same period.

The law creating the Coast Guard stipulated that it would constitute part of the country's military forces, but that it would continue to operate under the Treasury Department during peace time. In time of war, however, "or when the President shall so direct," the Coast Guard was to operate as part of the Navy, under the command of the Secretary of the Navy. And so, when the United States declared war on Germany in April 1917, President Wilson issued an Executive Order that transferred control of the Coast Guard to the Navy. In August 1919, with the war over, a second Executive Order transferred control back to the Treasury Department.

Domestic law enforcement soon became the primary mission of the Coast Guard after passage of the Eighteenth Amendment in January 1919 prohibiting the manufacture, sale, or transportation of alcoholic beverages in the United States after January 1920. The Volstead Act, passed over President Wilson's veto in October 1919, gave the Treasury Department's Bureau of Internal Revenue the authority to administer Prohibition, but enforcement through interception of contraband quickly



FIGURE 16. Coast Guard mounted beach patrol at Portsmouth, 1942. (CALO Coll.)

Historical Background & Context

became the Coast Guard's prime mission. Until repeal of Prohibition in 1933, the Coast Guard played an ongoing game of cat and mouse with the "rum runners," for whom the dimly lit, sparsely populated shores of the Outer Banks provided perfect shelter for their illicit activities. Inevitably, only a small part of the illegal alcohol that flooded into the country by land and sea was ever confiscated.

In July 1939, the Lighthouse Service, which had been organized in 1910 as part of the Department of Commerce, was made a part of the Coast Guard. This completed a consolidation of maritime-related bureaus that began with creation of the Coast Guard in 1915.

With the outbreak of war in Europe in September 1939, the Coast Guard was ordered to carry out neutrality patrols, since the country still maintained a neutral stance in the conflict. In June 1940, President Roosevelt invoked the Espionage Act of 1917 which governed the movement of all ships in U.S. waters and placed the Coast Guard in charge of

providing port security. A short time later, the Coast Guard was given jurisdiction over any ship carrying high explosives or other dangerous cargo. In March 1941, the Coast Guard seized over two dozen Italian, two German and nearly three dozen Danish merchant ships and by the end of the month had sent ten modern Coast Guard cutters on Lend-Lease to Great Britain.

On November 1, 1941, President Roosevelt transferred control of the Coast Guard to the Navy, and after Pearl Harbor, many inactive stations, including the one at Portsmouth, were reactivated. For the duration of the war, the Coast Guard played a vital role in the hostilities, landing Army and Marine troops in every major invasion in North Africa, Italy, France, and the Pacific. On shore, armed Coast Guardsmen patrolled beaches and docks, sometimes in vehicles but mostly on foot or horseback.

By 1944, the necessity of beach patrols was waning, and with the end of the war in August 1945, many of the reactivated Coast Guard stations, including the one at Portsmouth, North Carolina, were once again abandoned. In January 1946, the Treasury Department resumed control of the Coast Guard, whose primary responsibilities revolved again around safety at sea and aiding navigation.

During the Cold War, law enforcement again became an important component of the Coast Guard's mission, especially after the Cuban Revolution in 1959. In April 1967, by Executive Order, the Coast Guard was transferred from the Treasury Department to the newly-formed Department of Transportation. In March 2003, the Coast Guard was transferred again, this time from the Department of Transportation to the newly created Department of Homeland Security.



FIGURE 17. Detail from topographic survey of Portsmouth in 1866, annotated with arrow showing approximate site of Portsmouth Life-Saving Station. (U.S. Coast and Geodetic Survey, reprinted in Olson, 1982)

Portsmouth

Chartered as a port town in 1753, Portsmouth is located on the southwest side of Ocracoke Inlet, which was the principal access route into Pamlico Sound in the last half of the eighteenth and the first half of the nineteenth centuries. The town flourished in the 1780s and 1790s, and by 1800 as many as 250 people were in residence, making Portsmouth the largest settlement on the Outer Banks. Recognizing the town's commercial importance, the Fed-

eral Government established a customs house at Portsmouth in 1806, provided for a marine hospital in 1827, and authorized a post office in 1840. In 1842, Congress appropriated money to buy land and build a permanent marine hospital at Portsmouth. Completed in 1847 “on the waterfront . . . at the junction of House [Horse?] Island Channel and the Southwest Creek,” the hospital was a two-story building, 50’ by 90’, and the largest structure ever built in Portsmouth.¹⁷ By 1850, the town had a population of 463, a number which included 117 slaves. The town reached the zenith of its growth in 1860 when it had more than 600 residents and 109 dwellings.

On the eve of the Civil War, however, Portsmouth’s importance as a port was already in decline. A slow-moving hurricane on September 7- 8, 1846 reopened Hatteras Inlet some twenty miles north of Ocracoke, which provided much better access to the central coast of North Carolina. The new inlet soon began drawing traffic away from the shifting channels of Ocracoke Inlet, beginning a long period of decline for Portsmouth.

The Marine Hospital was closed in 1860, the same year that Edmund Ruffin (1794- 1865), the noted agricultural reformer, visited Portsmouth and described the town in *Agricultural, Geological, and*

17. Sarah Olson, *Historic Resource Study, Portsmouth Village, Cape Lookout National Seashore, North Carolina* (U. S. Department of Interior, 1982), p. 76.

Descriptive Sketches of Lower North Carolina, and the Similar Adjacent Lands:

The occupations of the whole resident population of Portsmouth are connected with the vessels which have to wait here. Pilots, and families and adult males - - and the remainder are the few who as shopkeepers, &c., are necessary to minister to the wants of the others. If Ocracoke inlet should be closed by sand (which is no improbable event) the village of Portsmouth would disappear - - or (like Nagshead) remain only for its other use, as a summer retreat for transient visitors, sought for health and sea-bathing.¹⁸

Evacuated during the Civil War, Portsmouth never fully recovered its population or its economic vitality after the war and the customs house was moved to New Bern in 1867. The government attempted to sell the old hospital building but was unsuccessful and allowed the U. S. Signal Corps to use it as a weather station between 1876 and 1885.¹⁹

As Portsmouth’s population declined, the number of residential buildings in the town dwindled as well, falling from a peak of 109 in 1860, to 59 in 1870,

18. Edmund Ruffin, *Agricultural, Geological, and Descriptive Sketches of Lower North Carolina, and the Similar Adjacent Lands*. (Raleigh, NC: Institution for the Deaf & Dumb & The Blind, 1861).

19. Sarah Olson, *Historic Resource Study, Portsmouth Village, Cape Lookout National Seashore, North Carolina* (U. S. Department of Interior, 1982), p. 76.



FIGURE 18. View west of Portsmouth from top of life-saving station, c. 1920. (CALO Coll. A-08)

Historical Background & Context

to 44 in 1880. By 1883, as Ruffin predicted, the shifting sands of the Outer Banks had closed Ocracoke Inlet to all but the smallest vessels, forcing a dwindling population to find other means of making a livelihood.

The United States Life-Saving Service's establishment of a station at Portsmouth in 1894 gave a boost to the community, offering employment to a few residents of the village. Washington Roberts, whose family had lived at Portsmouth for at least three generations, worked at the station for nearly thirty years, and Jesse Babb was employed for over ten years, first as a cook and then as a surfman and mechanic. Others, including George Dixon, worked as temporary substitutes on occasion. Most continued to make a living as fishermen, although that became an increasingly precarious existence as competition increased and over-fishing depleted stock. The Portsmouth Fisheries Company opened a cannery on Casey Island in 1916 and provided some work until it closed the operation in the 1920s.

In addition, some residents benefited from the hunting clubs that were established in the late nineteenth and early twentieth centuries. By 1900, the great flocks of water fowl that wintered on Pamlico Sound were attracting large numbers of wealthy sportsmen from Baltimore, New York and elsewhere, many of whom maintained hunting lodges on the Outer Banks. The Pilentary Club on Core Banks ten miles southwest of Portsmouth and the Harbor Island Club off Cedar Island were two of the best known, but up and down the Banks, residents worked as guides and cooks and provided other services for these hunters and their clubs.



FIGURE 19. Duck hunter with live decoys, near Portsmouth, December 1915. (CALO Coll. A-33)

Hurricanes and “nor’easters,” which could be as severe as hurricanes, appeared regularly, flooding the entire island and causing tremendous damage. After back-to-back storms in the summer of 1842, for instance, only one house was said to have remained standing at Portsmouth.²⁰ The 1890s were an extremely busy decade for the Atlantic seaboard with four major hurricanes sweeping the coast from Georgia northward, including the great “Sea Islands Hurricane” that killed as many as 2,000 people in Georgia and South Carolina in 1893. The worst along the Outer Banks was the “San Ciriaco” hurricane, which is also believed to be the longest-lived storm on record.²¹ Beginning in the tropical Atlantic on August 4, 1899, it devastated Puerto Rico on August 8, struck near Cape Hatteras ten days later, and reached the Azores before finally dissipating in early September. Believed to have been a Category 4 storm, the hurricane brought winds of 140 m.p.h. at Hatteras before the anemometer blew away. There was tremendous damage up and down the Outer Banks, and the storm precipitated permanent abandonment of the settlements that had grown up on Shackleford Banks near Cape Lookout in the last quarter of the nineteenth century.

Portsmouth, too, was heavily damaged, with the churches destroyed, houses off their foundations, and over 9’ of water inside the Life-Saving Station, which occupied some of the highest ground on the Island.²² Some residents abandoned Portsmouth after that, but there were still nearly 150 residents enumerated in the 1900 census. When another major storm destroyed the Methodist church again in September 1913, the community remained strong enough to support its reconstruction, although that did not occur until the summer of 1915.²³

The year 1933 set a record for the most hurricanes or tropical storms to form in the Atlantic basin, a record that stood until 2005, and two of those storms affected Portsmouth. On August 23, 1933, a moderate hurricane swept up the Outer Banks, dumping rain but not particularly strong winds on Portsmouth. The interior of the Coast Guard station

-
20. Draft HRS, citing David Cecelski, *The Waterman's Song: Slavery and Freedom in Maritime North Carolina* (University of North Carolina Press, 2001), p. 62.
 21. <http://www.aoml.noaa.gov/hrd/hurdat/>
 22. Station Log, August 16-19, 1899.
 23. Station Log, August 10 and September 13, 1915.

was flooded and much of the wharf destroyed, but for once the telephone line was not damaged. Less than a month later, on September 15-16, a strong Category 3 hurricane swept the Outer Banks. Portsmouth endured 100 m.p.h. winds, torrential rain, and a storm surge that flooded most of the island and destroyed many houses. The families of some of the surfmen at the Portsmouth Coast Guard Station sought refuge at the station, but it was soon flooded with nearly a foot of water on the first floor. At the height of the storm, the officer in charge recorded in the station log the next day, the entire building “was surging badly and expected to go away.”²⁴ The building held, but there was terrible damage all over Portsmouth. The Red Cross finally arrived with much-needed supplies on September 28, but according to one resident, who witnessed waves crashing through her dining room windows, the damage was so widespread that “everybody just left.”²⁵

The Core Bank Coast Guard station, which was built in 1895 using the same design as the Portsmouth station, was so badly damaged by the storm that part of its crew was assigned to Portsmouth in February 1934 while the Core Banks building was being repaired.²⁶ The station at Bodie Island was also heavily damaged and had to be abandoned for over a year before repairs could be made.²⁷

With this drain on its resources, the Coast Guard delayed major repairs to the Portsmouth station indefinitely. The station did continue to operate, however, but was deactivated on June 1, 1937, depriving Portsmouth of another reason for being. The station was reactivated in 1942, but by then, there were only 42 permanent residents of the town. In September 1944, the “Great Atlantic Hurricane,” a Category 3 storm, came ashore near Cape Hatteras, sinking two Coast Guard cutters near Oregon Inlet, killing 47 people and flooding Portsmouth again. By the end of World War II, even more residents of Portsmouth had relocated to the mainland.

The Coast Guard closed the Portsmouth station permanently in 1946, and by 1950 the village had only fourteen year-round residents. The post office

was discontinued in 1959; and by the time Cape Lookout National Seashore was authorized in 1966, only a handful of permanent residents remained. With the death of the village's last surviving male resident, Henry Pigott, in 1971, the only other residents, Elma Dixon and Marion Babb, moved to the mainland and Portsmouth was abandoned except for seasonal use.

Portsmouth Life-Saving Station

Congress authorized a life-saving station at Portsmouth, North Carolina, in 1888, but for unknown reasons, development of the station did not begin for five more years. The site was chosen by the District Superintendent of Construction Capt. C. A. Abbey, civil engineer Paul Bausch, and a committee that included the Keeper of the Cape Lookout Life-Saving Station William H. Gaskill, all of whom visited the site sometime between June 8 and June 11, 1893.²⁸ The site was surveyed on June 11, and an engineering report was completed at the same time.



FIGURE 20. “Plat of U. S. Marine Hospital Reservation at Portsmouth, N. C.,” showing location of new life-saving station, July 1893. (National Archives and Records Administration, Philadelphia, Record Group 26)

24. Station Log, September 15, 1933.

25. Olson, p. 93.

26. Station Log, February 14, 1934.

27. Joseph K. Opperman, *Bodie Island Coast Guard Station Historic Structure Report* (NPS, 2005).

28. Cape Lookout Life-Saving Station Log, June 8, June 11, 1893.

Historical Background & Context

powerful Gulf Stream, which kept them well away from the shoals and hazards along the Outer Banks, southbound shipping did not have that option and, especially when weather conditions were bad, often foundered in the treacherous waters off the Outer Banks. Ocracoke Inlet, which is the only one of the several inlets to Pamlico Sound that has remained continuously open throughout the historic period, offered its own hazards with shifting shoals and channels bringing disaster to many unwary pilots.

The federal government began to establish lighthouses and light stations as early as the 1790s, and a lighthouse was in operation on Shell Island at Ocracoke Inlet in 1797. By 1803, a lighthouse was also in operation at Cape Hatteras, and in 1823, a lighthouse at Ocracoke replaced the old Shell Island beacon, which had been struck by lightning and burned in 1818. In spite of these efforts, the sea continued to take a dreadful toll as sailing vessels were routinely blown onto the shoals and broken to pieces by the waves. Any crew that did not drown with the wreckage had little hope of escaping death from exposure once they reached what were, even in New England, sparsely-populated shores.



FIGURE 3. Sumner Increase Kimball (1834-1923), general superintendent of the United States Life-Saving Service. (CALO Coll.)

The Massachusetts Humane Society established the first "Huts of Refuge" along the Massachusetts shore in 1787, providing shelter at least for shipwrecked sailors. In 1807 they began to equip some of these shelters with boats and equipment that could be used by volunteers to make rescues at sea. Other volunteer organizations sprang up, but these were generally limited to areas around busy ports, especially the Long Island and New Jersey approaches to the harbor at New York. In any case, volunteers could provide help but to a few of the dozens of ships that wrecked along the Atlantic seaboard each year.¹

Origins

The origins of the federal government's Life-Saving Service can be traced to August 14, 1848, when Congress passed the Newell Act and appropriated \$10,000 for "surf boats, rockets, carronades and other necessary apparatus for the better preservation of life and property from shipwrecks" along the New Jersey shore. Eight lifeboat stations were built and equipped, and in 1849 additional appropriations allowed construction of fourteen stations on the shores of New Jersey and Long Island.

In 1850, a station was established in Rhode Island, and lifeboats and boat houses (but no live-saving stations) were also funded (but apparently never built) for the shores of the Carolinas, Georgia, Florida, and Texas. Administered by the Treasury Department's Revenue Marine Division (later the Revenue Cutter Service), the Life-Saving Service was perennially underfunded, and equipment and stations that were in place frequently fell into disrepair.

The loss of over two hundred lives in the wreck of the *Powhattan* off the New Jersey shore on April 16, 1854, spurred a Congressional investigation. Especially troublesome was the news that many of the bodies that washed ashore had been robbed by "shore villains," and the government had "no provision to prevent such depredations."² The wreck of the *New Era* at Deals Beach, New Jersey, in Novem-

1. The U.S. Coast Guard's web site at http://www.uscg.millhlg-cpl/history/h_USLSS.html provides a comprehensive history of the Life-Saving Service.
2. Means, Dennis R. "A Heavy Sea Running: The Formation of the U.S. Life-Saving Service, 1846-1878." *Prologue: Journal of the National Archives*, Winter 1987, Vol. 19, #4.

originally designed as a pantry. On the second floor were the crew's quarters, consisting of a large open room flanked by closets, as well as a "spare room" for visitors. The second floor also had a large storage room and there was additional storage space in the attic, which was completely floored. From the attic level, another set of stairs rose to the watch tower at the fourth floor level.

Outbuildings

As with all life- saving stations, the Portsmouth station included a variety of ancillary structures. These included an oil house, a privy, stables, and, much later, a "summer kitchen," but there were other structures as well.

Oil House. Located about 60' northwest of the station³¹, the oil house was a small wood- framed structure that was also built in 1894. It was designed for storage of kerosene, or "coal oil" as it was often called, which was used for lighting; linseed oil and turpentine, which were used for mixing paint; coal, used for heating; and any other flammables that would be a hazard if stored inside the station itself. "Torn up" for the first time by a hurricane in 1896, frequently damaged and repaired after that, it was finally removed prior to or in the early 1940s.³²

Privy. Originally, the station did not have indoor bathrooms, only a wood- framed privy located just east of the station. It was apparently not built over a pit but rather constructed in such a way that the tidal flow would flush away the waste. A new privy was constructed in 1910, only to be damaged when it was blown into the creek in the September 1913 hurricane. Also damaged repeatedly, a privy remained a fixture at the site at least into the 1940s.

Stables. In various entries, the station log books refer to "stables" and a "barn," but it is likely that these were the same building. The station may not have had horses at first, since stables were not completed until August 1896. Little is known of this building except that it was kept whitewashed and was located in the vicinity of the present barn, which apparently dates to 1928. The original stables were swept away, "with horses in them," during the 1899 hurricane but were replaced the following year. Reference to repair of the "old stables" in 1910 suggests that new stables were constructed that year.³³ The last of the horses were taken away in 1932, after which the old barn was used as a garage and storage building.³⁴

Boat House. Although the station house had a large boat room, the crew constructed a boat house "on the outer beach" in 1897 in order to shorten the arduous work of hauling the boat wagon back and forth from the station to the beach. It was damaged

31. Location is documented by the 1903 plat map of the station (revised in 1909).

32. Station Log, October 11, 1896. The building is absent from historic photographs taken during World War II.

33. Station Log, August 8, 1910.

34. Station Log, March 19, 1932.

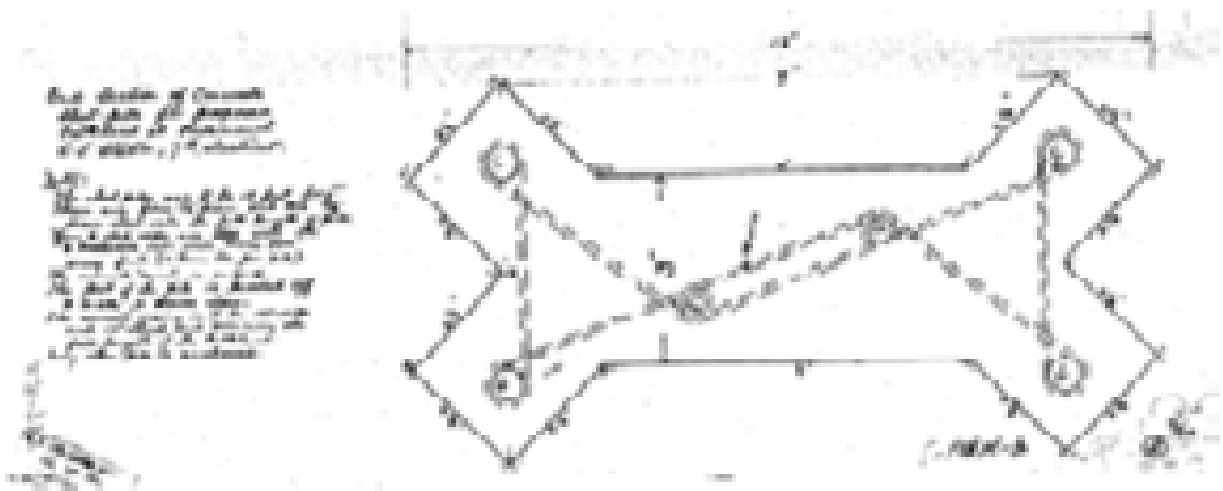

FIGURE 22. "End Section of Concrete Sheet-pile for Proposed Bulkhead," July 9, 1914; used to construct seawall in 1915. (National Archives and Records Administration, Philadelphia, PA, Record Group 26)

Historical Background & Context

in the 1899 hurricane before being condemned for use in 1905. The crew salvaged the building, however, by moving it back to the station yard and repairing it as a shelter for the Monomoy surf boat.



FIGURE 23. View of the wharf at Portsmouth Coast Guard Station in the 1920s. (CALO Coll. A-09)



FIGURE 24. View of abandoned stables and boat house in 1946. (CALO Coll. A-46)



FIGURE 25. Coast Guardsmen at Portsmouth, 1942. Note privy over creek at right. (CALO Coll. B-32)

Other Structures. In early 1895, the crew put up a “wreck pole,” which simulated the mast of a ship and was used for rescue drills.³⁵ It was located 75’ or 80’ west of the summer kitchen. Also in 1896, the crew constructed a wooden breakwater along the creek on the east side of the station. That same year they also constructed a “dam” at the head of the creek just southeast of the station. The dam was back-filled with sand, thus shortening the creek considerably and, presumably, helping to maintain a deeper channel.

Over the winter of 1899-1900, the crew built a “carriage house” or “cart house,” which was probably used to shelter the wagon used to haul the surf boat and/or the “carriage” for the Lyle gun, which was used to shoot rescue lines to wrecked vessels. No such structure appears on any plats of the station grounds, and nothing else is known about this building.

In 1913, the crew erected a steel “coastal warning display tower”, that was part of a hurricane warning system for ships that was begun by the National Weather Bureau in 1898. A series of red and red-and-black flags or pennants were flown from the tower to alert small craft and ships at sea to bad weather. At night red and white lights were used as a warning signal. A more elaborate system of flags was used to indicate forecast weather conditions, but after 1925, use of the warning towers was discontinued as radio communication came into use for providing weather reports and warnings. Located between the wreck pole and the summer kitchen, the Portsmouth tower was blown down in the hurricane of September 1933.

In the fall of 1914, the crew began replacing the old wooden breakwaters, first constructed in 1896 but frequently damaged or destroyed by storms, with the concrete bulkhead or seawall that now lines the western side Coast Guard Creek. The seawall was built with reinforced-concrete sheet piles and a continuous reinforced-concrete coping, and it greatly reduced the erosion of the shoreline in the vicinity of the station.

In the summer of 1915, the crew spent many days taking up the old wooden walkways around the sta-

35. All construction dates in this section are documented by the station log books.

tion grounds and pouring new concrete walkways as well as building concrete ramps to the boat room doors of the main station building. The walkways and ramps were completed that fall, but material shortages interrupted work on the seawall in January 1916, and the last 103' of the wall were not completed until early in 1918.

Plans were also drawn in 1913 for construction of a walkway or pier extending into Ocracoke Inlet as well as a boat house on the pier that would have included a hoist for dry docking the boats. Actual construction of the pier was delayed until 1916, however, and it is not clear if the boat house was ever constructed at all.³⁶

In October 1917, a cable was finally laid across Ocracoke Inlet, making telephone service available at Portsmouth for the first time. No longer did the Keeper have to send a surfman to Ocracoke or to Hatteras to use the telegraph, and although the lines were often damaged by storms and waves, telephone service between the Portsmouth station and other stations and district headquarters was an enormous benefit, especially in emergencies.

Few changes were made to the station before it was decommissioned in 1937, although in 1921, a round metal cistern, similar to the one now located at the Portsmouth Schoolhouse, was assembled and set up at the end of the porch on the southeast side of the station. In addition, a new barn was constructed in 1928, and there may have been some other structures that have not yet been documented.

Much of the damage from the 1933 hurricane was not fully repaired, and since free-ranging livestock on the island was eliminated in the 1920s, the fencing of the station compound was never reconstructed. A number of changes were made when the Coast Guard re-activated the station during World War II. Historic photographs suggest that the oil house and some of the other outbuildings were removed around that time.

Summer Kitchen. When first constructed, the Portsmouth Life-Saving Station did not have a separate “summer kitchen.” All cooking was done in the kitchen that was originally in Room 102, with the surfmen’s dining or mess room located in Room

36. Station log books document this work.



FIGURE 26. Keeper Charles S. McWilliams, seated, and crew of the Portsmouth Life-Saving Station in 1910. The only surfmen who can be identified are long-time #1 surfman Washington Roberts, left, and #5 Surfman Mitchell Hamilton, third from left. (CALO Coll. F393)

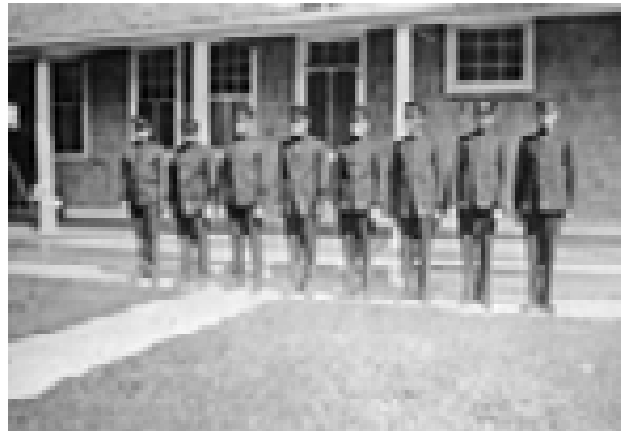

FIGURE 27. The crew of the Portsmouth station in the late 1920s. Mitchell Hamilton, left, and Merwyn Taylor, right, are the only surfmen who can be identified. (CALO Coll. A-05)



FIGURE 28. Coast Guardsmen at Portsmouth in 1942. Note privy over creek in background. (CALO Coll. B-32)

Historical Background & Context

104. The exact date of construction of the summer kitchen is not known, but it was certainly in place by the time the 1903 plat of the station grounds was revised in 1909. It seems likely that construction of the summer kitchen began in May 1908 when the station log records the arrival of George T. Hale “to begin work on station” and, two days later, “Mr. Shull, the contractor who is to repair this station.”³⁷ The station logs make reference to no other large-scale construction projects that could include the summer kitchen. The first reference to the summer kitchen in the station logs was in September 1913 when the hurricane that destroyed the Methodist church also took the top off the kitchen chimney.³⁸ The first reference to a full-time cook for the station does not come until August 1918, indicating that the crew rotated cooking duties or else hired somebody from the village to cook for the crew.³⁹

Historic photographs show that the original kitchen or “cook house” was a one-room, end-gabled building with wood-shingled walls and roof. Photographs also show that during World War II, probably in 1942, the building was expanded to the east by the addition of a dining room, with the addition finished on the exterior with shiplap siding instead

of the shingles used on the original portion of the building.⁴⁰

Personnel

Each station had a Keeper in charge of station operations and responsible for hiring and supervising a crew of six or eight “surfmens.” As noted above, a cook was employed at Portsmouth beginning in August 1918. Prior to organization of the Coast Guard in 1915, the keeper and the crew were almost always local residents. With the advent of gasoline-powered motor boats in the early twentieth century, it became practical for men living further up the Banks or even on the mainland to work at Portsmouth and still be able to take the short one or two day leaves of absence that were routinely granted. After 1915, most of the crew at the Portsmouth station continued to reside in the village but by the 1930s, crew members often had permanent residences on the mainland at Atlantic, Sea Level, Davis, and even New Bern, or on the Outer Banks at Rodanthe, Frisco, and some of the other settlements around Cape Hatteras. In the late 1920s and early 1930s, there were even a few surfmen with home addresses as far away as Michigan and Rhode Island.

37. Station Log, May 27 and 29, 1908.

38. Station Log, September 3, 1913.

39. Station Log, August 6, 1918.

40. This addition is not mentioned in the station logs, but it does appear in historic photographs after 1940.



FIGURE 29. Portsmouth Coast Guard Station, c. 1920. (CALO Coll. A-01)

Keepers. Given that most of the Life- Saving Service's early employees on the Outer Banks were local men, it was somewhat unusual that the first Keeper of the Portsmouth Life- Saving Station, Ferdinand G. Terrell, was actually a native of New York. Born on Long Island about 1856, he was working as a "bayman," or oyster gatherer, in 1880 and was living in Brookhaven, Suffolk County, on Long Island. He married around 1887 and appears to have had a single child before his appointment as Keeper of the Portsmouth Life- Saving Station on August 22, 1894. He resigned the position on October 8, 1903, perhaps because of health problems, and by 1910 was apparently operating a grocery store at Pantego, a small town about 30 miles east of Washington, NC. He died sometime after 1920.⁴¹

Terrell's replacement was Charles S. McWilliams, born in North Carolina in May 1871. Married about 1892, he was working at the Ocracoke Life- Saving Station in 1900 and had at least six children by 1910. Appointed on November 25, 1903, McWilliams served longer than any other Keeper of the Portsmouth station and oversaw the station's transition to Coast Guard control. Under the Coast Guard, the stations no longer had "keepers" but rather "officers in charge." McWilliams was forced to retire on permanent disability on February 24, 1916.

After Terrell and McWilliams, a succession of officers was put in charge of the Portsmouth Life- Saving Station, either on a permanent or an acting basis, but most were there for relatively brief periods. McWilliams was replaced by Albert L. Barco, who was born in Virginia around 1876 and appointed Acting Keeper at the Portsmouth station in February 1916. He received a permanent appointment in September of that year, but in April 1917 was transferred to Station 164 at North Bay, Cape Henry, Virginia. Barco was replaced by Mitchell Hamilton, a North Carolina native born about 1878. Hamilton apparently purchased a house in Portsmouth and remained a little over three years before leaving to become Assistant to the District Superintendent in December 1920.

After Hamilton's departure, there was no permanent officer in charge for nearly four years. For

much of that time, Portsmouth- native Washington Roberts, who had signed on for service when the station opened in 1894, was in command. Not until November 1924 was Joseph Emery appointed Officer in Charge. Born about 1878, probably on the Outer Banks, Emery was Keeper at the Nags Head Life- Saving Station before being assigned to the Oregon Inlet station and, in 1924, to the Portsmouth station. He served a little over four months before being transferred to Elizabeth City, North Carolina, where he, like Hamilton, served as Assistant to the District Superintendent.

Roy Robinson, born in North Carolina in 1895, was one of the youngest officers to command the station when he was transferred from the Hatteras Inlet station to assume command of the Portsmouth station in July 1925. He, too, bought a house in Portsmouth and remained in charge of the station until he was transferred to the life- saving station at Fort Macon near Beaufort, North Carolina, on December 21, 1931.

George H. Meekins, another North Carolina native, succeeded Robinson in December 1931. Born about 1890, he served until July 1932 when he was reassigned as Officer in Charge of the Big Kinnakeet Life- Saving Station.

Elisha G. Tillet, a surfman at the Nags Head station born about 1898, assumed command at Portsmouth on July 1, 1932, and was in charge during the dreadful hurricane season of 1933. He was replaced by Julian L. Gray on January 23, 1935. A North Carolina native born about 1905, Gray had worked as a surfman at the East Hampton Life- Saving Station on Long Island and was the officer in charge when the Portsmouth Life- Saving Station was decommissioned on June 1, 1937.⁴²

Crew. Unlike the Keeper, who was present year-round, the station's crew was present only during the "active season," which ran from September 1 through April 30 until 1897, after which it extended from August 1 through May 31. In 1916, after creation of the U. S. Coast Guard, crews were employed year- round. If disaster struck during the off- season, as it some times did, the Keeper was forced to

41. U. S. Federal Census schedules, 1850-1930, document age, marital status, home town, home ownership, and other details of the lives of the officers and crew at the station.

42. There is some conflict between sources in the dates of tenure for the officers in charge. Dates in this paragraph are based upon entries in the station logs for Portsmouth.

Historical Background & Context

round up a crew from local fishermen. Surfmen were also hired on a temporary basis when illness, liberty for crew members, or other absences left the station with less than a full crew. Local men like George Dixon might serve at sporadic intervals for years, with apparently no desire for full-time employment.

A temporary crew was in place at the Portsmouth station by early November 1894, but the permanent crew did not sign their articles of engagement until March 11, 1895. That original crew included Joseph W. Roberson, George Dixon, Joseph Styron, Augustus

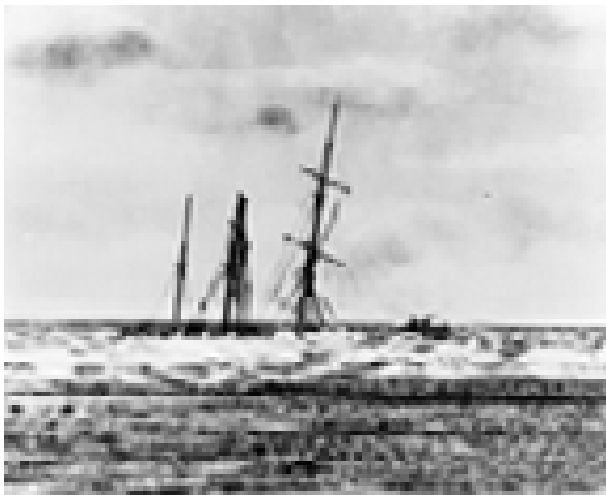

FIGURE 30. Three-masted schooner breaking up in the surf. (CALO Coll. G-02)



FIGURE 31. Surfman on beach patrol. (CALO Coll. G-08)

Mason, George R. Willis, Dennis Mason, and Washington Roberts, but for unknown reasons the district superintendent ordered the discharge of Roberson, Dixon, and Styron less than a month later. They were replaced by Martin Dixon, George Gilgo, and David Salter, but only Gilgo remained in service two weeks later. By the time the crew reported back to the station on August 1, 1895, a more or less permanent crew was established, consisting of Dennis Mason, Washington Roberts, Augustus D. Mason, James T. Salter, George R. Willis, George W. Gilgo, and Jesse J. Newton.⁴³

The crew at the Portsmouth Station, as at most life-saving stations, did not remain the same for very long, with crew members leaving for a variety of reasons, including sickness, injury, and simple boredom with the station's routine. Usually surfmen resigned their commissions or refused to re-enlist if they were unhappy with the work, but sometimes the Life-Saving Service had to make that decision for them, as it did in December 1919 when twenty-year-old Norwood Roberts was discharged for "inaptitude" [sic] for service after a brief probationary period. Most unusual was Washington Roberts, a distant cousin of Norwood Roberts, who signed on as a young man of twenty-one in 1894 and worked at the Portsmouth station for nearly thirty years, retiring early in 1925.

The surfmen's positions in the crew were numbered, with the #1 position generally going to the man with the longest, most reliable service. The #1 Surfman generally took charge of the station during the Keeper's absence. In 1918, the Keeper enlisted a cook, apparently for the first time, bringing the total number of men at the station to ten.

Patrols and Rescue

The main mission of a life-saving station was, of course, search and rescue, and there were routine drills in proper techniques. During the active season, watch was kept from the lookout tower during the day, and there were patrols of the beach itself at night or whenever there was fog or reduced visibility. According to a newspaper account of a visit to Portsmouth in 1921, the station's crew often used their own ponies for patrol.

43. Station logs identify crew members.

At night the Portsmouth Coast Guard ride their own ponies along the beach in all the dark hours; two miles to Ocracoke Inlet one way and 3- 1/2 miles down the beach the other way. Queer little stables house these ponies, handsome animals, which are found wild on the “banks,” between Portsmouth and Cape Lookout mainly. They are “penned each year by men who drive them, and one of these “pens” is right in the village in 300 yards of the Coast Guard station.⁴⁴

To insure that patrols were actually taking place, time keys were stationed at the north and south ends of the patrol, and the man on duty was required to key into the clock carried on each round, making indentations on small metal plates that could then be checked by the Keeper before being sent to District Headquarters for verification. Failure to key into the clock could mean loss of liberty or, if there were repeated offenses, dismissal from the service.

Part of the crew’s duties was simply to warn ships away from the shoals, using a kerosene lamp with a red chimney as a signal. Often, however, the crews’ first sighting of a vessel came when it was already aground. In those circumstances, the lifeboat was quickly launched and rowed out to the wreck site. Unlike the crew at the Cape Lookout Life- Saving Station, which often spent most of a day or night reaching vessels aground far out on the shoals below the cape, the Portsmouth crew’s range was generally no more than three miles. The treacherous shoals of Ocracoke Inlet grounded many unwary pilots, and a significant portion of the station’s rescues involved refloating those grounded vessels.

The first major incident calling the Portsmouth station into action occurred on December 27, 1894, when the schooner *Richard S. Spofford* ran aground off the beach at Ocracoke. A life- saving station would not be built at Ocracoke until 1904, so it was left to the Portsmouth crew to effect a rescue. The *Spofford*’s small boat capsized as part of the crew tried to escape, but residents of Ocracoke rescued five of the crew by joining hands and wading out into the surf. Three crew members remained on board, and with heavy surf breaking over the schooner, the Portsmouth crew could not get the station’s small boat close enough to rescue the men.

44. Fred A. Olds, “The Barrier Reef,” *The Orphan’s Friend and Masonic Journal* (Oxford, NC), October 28, 1921.

And so, Keeper Terrell noted in the station log, he and the crew from the station at Hatteras “kept watch on the beach all night, also fires to encourage sailors” still on board. At daybreak, they were finally able to rescue two of the men, but the third crew member “perished.”⁴⁵

Perhaps, the best known of the Portsmouth station’s rescues was that of the barkentine⁴⁶ *Vera Cruz* that went aground on Dry Shoal Point near Portsmouth on May 8, 1903. Originating in the Cape Verde Islands and carrying some 371 hopeful immi-



FIGURE 32. Launching a surfboat. (CALO Coll. G-03)



FIGURE 33. Passengers from the *Vera Cruz* disembarking at New Bern, May 1903. (CALO Coll. C-32)

45. Station Log, December 27-28, 1894.

46. A barkentine is a three-masted vessel with square-rigged foremast and fore-and- aft rigged main and mizzen masts.

Historical Background & Context

grants⁴⁷, the ship was abandoned by its Portuguese captain, who is reported to have paid a local man \$50 to take him to Belhaven where he said he had to go to wire the ship's owner. No one saw the captain after that, and it was left to the Portsmouth Life-Saving Station crew to retrieve the passengers. The rescue required thirty-two trips in the life boat plus every available skiff in the community before all the passengers were ashore.

The government kept the station supplied with equipment and provisions, and the Women's National Relief Association provided routine shipments of clothes, blankets, sugar, tea, reading matter, and other items for disaster victims. In the case of the *Vera Cruz*, all of these supplies were quickly exhausted. In the end, feeding, clothing, and housing the unfortunate people nearly overwhelmed the resources of the entire village before the Revenue Cutter *Boutwell* was able to take the immigrants to New Bern. Ultimately nearly all of them were deported, without the personal money that they had given to the erstwhile captain for safe keeping.

Most incidents at the Portsmouth station were less dramatic than the rescue of the *Vera Cruz*. The Portsmouth station commanded a full view of Ocracoke Inlet, and most of its work involved ships grounding on the shoals around the inlet. In many cases, the vessel had to be emptied of whatever it was carrying in order to get it afloat again, and most of that work was done by the surfmen.

Rescue missions were not limited to ships at sea but included rescue of local fishermen as well. In February 1895, for instance, nine oyster fishermen from the mainland at Davis sought refuge at the Portsmouth Life-Saving Station for nearly nine days, "there being so much ice [they] was afraid when it broke up, they would be carried to sea."⁴⁸ On another occasion, the Portsmouth station supplied twenty-four people who were ice bound at Harbor Island Club, one of the hunting clubs down the banks from Portsmouth.⁴⁹ With the advent of motor boats in the early 1900s, more of the station's efforts went to the rescue of small craft, almost always because of engine trouble. By the end of World War

I, radio communications had made large-scale shipwrecks a rarity and fundamentally changed the nature of the Life-Saving Service's work.

Community Relations

Besides being a prominent physical landmark, the life-saving station was often a place of refuge for residents of Portsmouth, especially families of the crew. During the dreadful San Ciriaco hurricane in 1899, which locals remembered as "the great August storm," the tide "was over a man's head in all this part of the world," according to one account, "and people got on roofs or in garrets that dreadful night."⁵⁰ The keeper recorded in the station's log that the families of Charles and Daniel Willis, neither of whom worked at the station, were rescued and taken to the station after their houses were swept from their foundations by the storm.⁵¹

The Portsmouth Life-Saving Station was an integral part of the community's social and economic life. Throughout its history of operation, most of the life-saving station's men were or became residents of Portsmouth. It might be argued that, without the Life-Saving Service's station, Portsmouth would have withered much faster than it did, since no small part of the village's economic vitality was because of the regular income of the station's crew.

The station also assisted local residents with emergency communications, transportation, and even medical assistance. In October 1895, the Keeper at the Portsmouth station reported that "Mrs. Ackins a lady boarding at Portsmouth was taking [sic] with cramps [and] scent [sic] to the Station for Jamaica ginger, as she could get none on the island, [and] so the Keeper let her have some."⁵²

On more than one occasion, the life-saving station crew had the grim task of retrieving and burying the dead. Usually bodies were found simply washed up on the beach, but in February 1904, one of the surfmen came upon "a yawl boat partly full of water with a Negro man frozed [sic] to death in it."⁵³ The bodies were almost never identified, and it was left to the station crew to build a coffin and bury the

47. In the station log, Terrell counted 371 passengers; other sources put the number over 400.

48. Station Log, February 8-17, 1895.

49. Station Log, January 5, 1918.

50. Olds, "The Barrier Reef," October 28, 1921.

51. Station Log, August 17-18, 1899.

52. Station Log, October 2, 1895.

53. Station Log, February 13, 1904; also see August 24, 1899, January 22 and March 11, 1900, August 29, 1901, September 19, 1913.

dead. The crew even built coffins for local residences, including one for Washington Robert's mother when she died in November 1913 and another for George Dixon's wife when she died in March 1914.⁵⁴

Sometimes the crew's aid to the local community was more than incidental. For three days after the 1913 hurricane, for instance, the crew worked with locals to raise the school house which had blown or floated off its foundation during the storm.⁵⁵ Two years later, when the local congregation could finally begin rebuilding the Methodist church, it was the life-saving station crew that spent two days unloading lumber for the reconstruction.⁵⁶

Security and Law Enforcement

As noted above, the Navy's need to patrol the coasts during the Spanish-American War prompted the War Department to assign the coast-watching mission to the Life-Saving Service. The Spanish fleet was never observed at Portsmouth or anywhere else

along the Atlantic seaboard, but the experience began the militarization of the Life-Saving Service. With the outbreak of war in Europe in 1914, helping to secure the coasts became a primary focus and the station was often on alert. Stations were issued circulars showing the silhouette of German submarines and other types of shipping, but the Portsmouth station apparently never made any of those sightings. Nor did they spot the six German officers who left a cruiser at Norfolk in October 1915 and were presumed to be working as spies.⁵⁷

In 1919, passage of the Eighteenth Amendment prohibiting the sale of alcohol increased the Portsmouth station's work load significantly. In addition to rescue of crew and passengers of grounded vessels, the station was now tasked with search and seizure of contraband, sometimes including seizure of the vessel itself. In December 1921, the schooner *Message of Peace* ran aground in Ocracoke Inlet, and almost immediately, district headquarters telephoned the station, ordering them to seize the vessel until the Coast Guard cutter *Pamlico* arrived. Bound to New York from the Bahamas, the *Message of*

54. Station Log, October 29, 1913, March 11 and September 8, 1914.

55. Station Log, October 7-9, 1913.

56. Station Log, August 10, September 13, 1915.

57. Station Log, October 15, 1915.



FIGURE 34. View to west of Portsmouth in 1969, with Portsmouth Life-Saving Station at lower left. (CALO Coll. C-08)

Historical Background & Context

Peace was loaded with contraband whiskey, and while the station log indicates that the ship was carefully guarded, a resident of Portsmouth later remembered that “the island had all the whiskey they wanted to drink for quite awhile” after that.⁵⁸

In the early 1920s, the Coast Guard was woefully under-equipped to deal with the flood of liquor from “rum runners” into the country. With thousands of miles of coast line to patrol, only a fraction of the supply was interdicted before reaching the mainland. After May 1925, attempts at enforcement of Prohibition were stepped up, and in the late 1920s, the Portsmouth Coast Guard Station was even required to station pickets at Ocracoke Inlet after dark. Repeal of Prohibition in 1933 brought an end to this police work and contributed to the obsolescence of many of the Coast Guard’s coastal facilities. That same year, the Portsmouth station got its first and only truck, which was shipped up from the station at Cape Lookout, and the last of the horses was shipped out of the station. But by then, a life-saving station at Portsmouth was becoming more and more difficult to justify.

58. Station Log, December 30-31, 1921; Ben B. Salter, *Portsmouth Island, Short Stories and History* (Privately published, 1972), p. 45.

Portsmouth was one of many stations that were closed in 1937 and 1938, although the Coast Guard retained ownership of most of the stations. After Pearl Harbor, the Coast Guard reactivated a number of these stations, including Portsmouth, to meet the war-time need for coastal observation. In 1942 or 1943, the station was remodeled, and for two years during the war, the beaches at Portsmouth were patrolled by Coast Guards patrols on horseback.

In 1945, the Coast Guard closed the Portsmouth station permanently and, in March 1946, formally conveyed the property to the War Assets Administration. In the early 1950s, the Brant Rock Rod and Gun Club acquired the old station for a private club house. They were responsible for creating a landing strip that obliterated what little remained of the old Marine Hospital. The old life-saving station was occupied on a seasonal basis until it was incorporated into the Cape Lookout National Seashore in 1977. The Portsmouth Coast Guard Station was listed on the National Register of Historic Places on November 29, 1978, at a state level of significance for its association with the U. S. Life-Saving Service on the Outer Banks and for its role in the history of Portsmouth Village.

Chronology of Development and Use

Constructed in 1894 with only slight modifications to a standardized, Shingle- Style design and plan, the Portsmouth Life- Saving Station is the best-preserved of the twenty- one Quonochontaug- type stations that the Life- Saving Service built between 1891 and 1904. As noted in the previous section, only ten of these buildings remain, and except for the Portsmouth station, all of those have undergone major modifications.

Most of the significant alterations to the station, including replacement of the original plaster walls and ceilings and the original door hardware, occurred during the historic period. The original floor plan remained unchanged, except for construction of the lightweight partition in Room 103, probably in 1908; closure of the door opening between Rooms 102 and 104, which probably occurred around 1914; and installation of the gun closet in Room 101, which probably occurred in the late 1910s or 1920s.

The station flooded on several occasions, necessitating repairs to the plaster walls as early as 1904. Two wash rooms were created in 1908, but a privy remained a fixture at the station as late as the 1940s. The original lock sets, knobs, and escutcheon plates at all interior doors were replaced in 1913, although all of the original doors remained in place. There has probably been some replacement of window sash due to storm damage, but the original six-over- two muntin pattern has not been changed. Nearly all of the original plaster on wood lath was replaced with plaster on rock lath, probably when the station was reactivated during World War II, but the building was never wired for electricity. The NPS added a shower in Room 102 but later removed all plumbing fixtures from the building. The cedar-shingle siding and roofing were completely replaced in 1978.

Although it has apparently not been occupied on a year- round basis since the end of World War II, the station has always been used primarily as a residence. Only the boat room did not serve that residential function, historically being used for storage and maintenance of the station's boats or, as in recent years, for the storage and maintenance of lawn tractors and other equipment.

Original Construction

Authorized in 1888, construction of the life- saving station at Portsmouth was inexplicably delayed for nearly six years. Since the Federal government already owned a large tract of land on which the old Marine Hospital was built, it is unclear what caused the delay in construction, although it was not unusual for several years to pass between the time a station was authorized and the time construction began. At Cape Lookout, for instance, eight years elapsed between the time Congress authorized the station and the time the station was actually constructed. As noted earlier, construction may not have begun until the spring of 1894, but the Superintendent of Construction reported that it was completed on June 28, 1894. The first entry in the Portsmouth station's log is dated September 30, 1894, which may be the date the building was first occupied, but the first crew of surfmen was not on duty until November of that year.

Site

On June 8, 1893, the Life- Saving Service's Superintendent of Construction Capt. C. A. Abbey and civil engineer Paul Bausch were at Cape Lookout Life- Saving Station to pick up the Keeper of that station, William H. Gaskill. He was part of a committee

Chronology of Development and Use

appointed to select sites for the new life-saving stations to be built at Core Bank and at Portsmouth.⁵⁸

They must have made their decision by June 11, when the first survey was drawn of the Portsmouth site, showing the location of the new station. (See Figure 19.)

58. Cape Lookout Life-Saving Station Log, June 8, 1893.

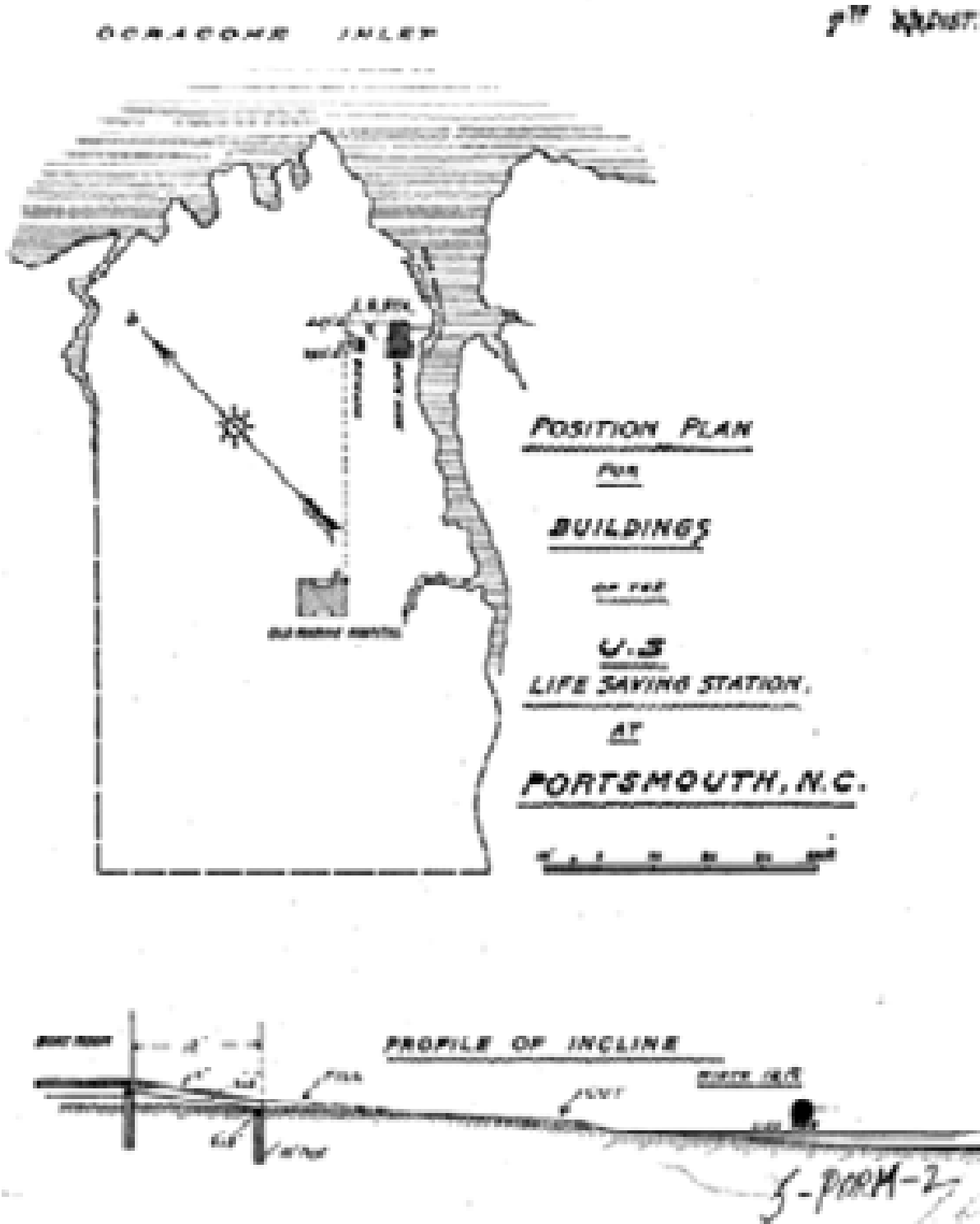

FIGURE 35. "Position Plan for Buildings of the U. S. Life-Saving Station at Portsmouth, N. C.," probably summer 1894. This plat is a revision of the plat of the proposed site that was drawn in July 1893 and shown in Figure 20. (National Archives and Records Administration, Philadelphia, PA, Record Group 26)

The old Portsmouth Marine Hospital, which was located less than four hundred feet west- southwest of the present building, was apparently still standing in 1893, since it is depicted on the plat of June 11. The hospital occupied some of the highest ground on the island and provided a clear view of Ocracoke Inlet and of both the ocean and sound sides of Portsmouth Island. There may even have been some thought of adapting the old hospital building, but that was soon laid to rest when the building was burned, apparently deliberately, sometime later that year.

In addition, the nature of the shallow tidal creek that ran to the east of the old hospital site was surely a factor in locating the new life- saving station. Storms frequently washed large quantities of sand into the creek, and constant dredging would have been necessary to keep open a channel from the hospital site to Ocracoke Inlet. In 1908, the station crew built a dam across the head of the creek just south of the station and the creek was filled in completely from that point westward.⁵⁹ Rather than the

inland site of the marine hospital then, the new station was located much closer to the mouth of the creek where water was generally deep enough for a boat launch. Even then, keeping a channel open to deep water remained a challenge for the station's crew.

The boundaries for the large tract of land on which the hospital had stood were reduced considerably for the life- saving station. Bounded by Coast Guard Creek on the southeast and Ocracoke Inlet on the northeast, the station reserve was only about a sixth of the area of the old hospital reserve and did not extend much further northwest and southwest than the present buildings on the site.

The original station compound was a square of about 150' on each of three sides with the creek forming the fourth side of the square. The compound was originally fenced, using 4" by 4" posts and 1" by 6" boards, with the fence parallel to the building about 35' away from its northeast end and about 58' away from its southwest end. That first fence was washed down during the hurricane of 1899, but it was replaced, only to be destroyed again

59. Station Log, August 11-12, 1908.

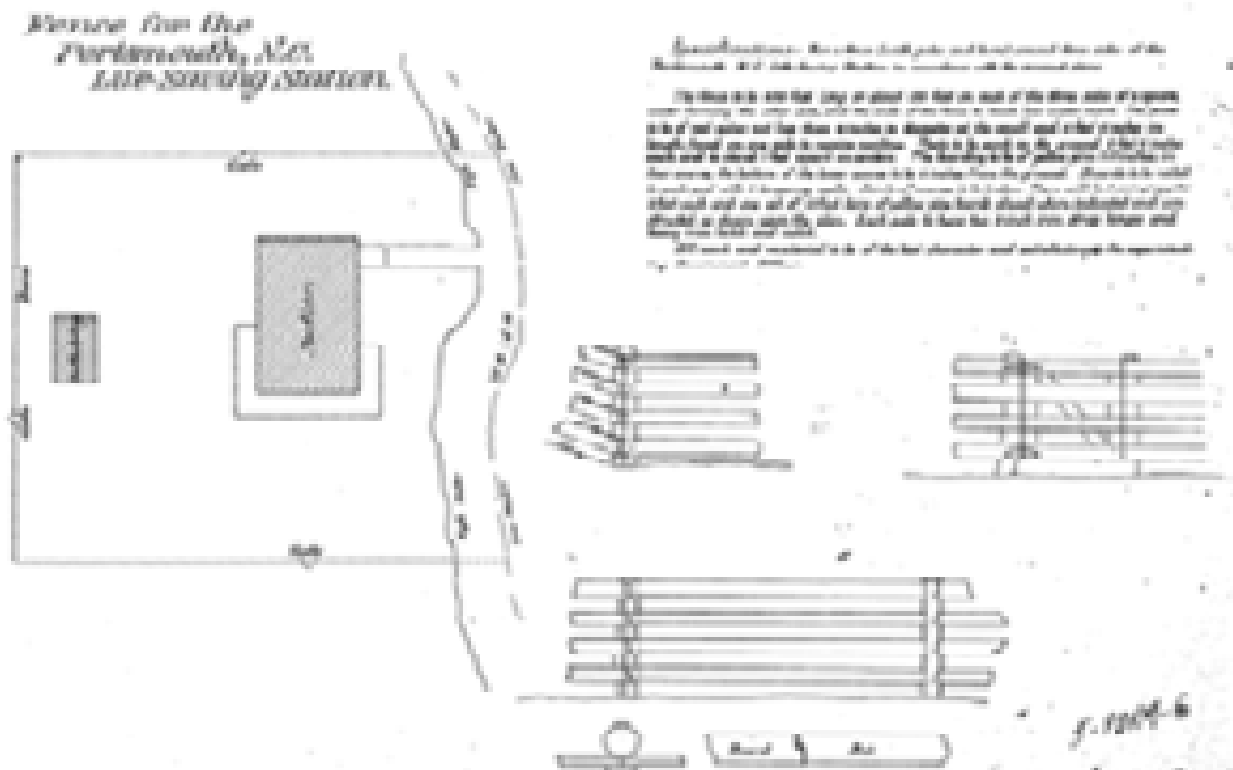

FIGURE 36. Undated plans, probably 1894, for fencing of the station compound. A barn was soon built outside this compound. (National Archives and Records Administration, Philadelphia, Record Group 26)



FIGURE 37. Plans originally drawn for the life-saving station at Quonochontaug, Rhode Island. (Taken from York, "Architecture of the United States Life-Saving Service," 1972)

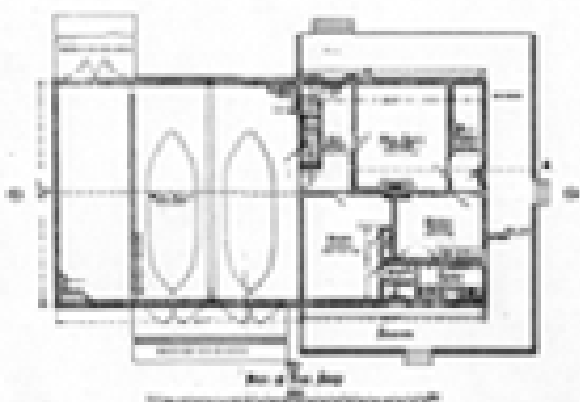

FIGURE 38. Tolman's plan for the life-saving station at the World's Columbian Exposition, 1893. (Taken from York, "Architecture of the United States Life-Saving Service," 1972)

in 1913. Sections were frequently damaged by other storms. With the end of free-ranging livestock in the 1920s, there was less need for a fence, and after the fence was washed away again in September 1933, it was not replaced.⁶⁰

Original Plan

As the site for the new station was being surveyed, the Life-Saving Service was also planning for the building's construction. On July 31, 1893, the Service's General Superintendent wrote to C. A. Abbey, the Service's Superintendent of Construction, concerning "the intention to build new stations at Cahoon's Hollow, Spermacetti Cove, Avalon, [all in New Jersey] and Portsmouth, N. C.," and asking if there would be "objections" to using the plans for the Brant Rock (Massachusetts) Life-Saving Station, built in 1892, or the Ditch Plain (New Jersey) Life-Saving Station, built in 1886. The next day, Abbey responded:

We see no objection to the use of the Brant Rock plans at all the points named for the reason that such houses are well adapted to the present needs of the Service. The addition of an inexpensive verandah on the South side of the Portsmouth house is very desirable, and is probably the only change that will be necessary in the drawings.⁶¹

The Ditch Plain Life-Saving Station, constructed near Montauk Point on Long Island, New York, in 1885, was similar to the station built at Cape Lookout in 1887, with both following a plan developed by Parkinson in 1882. The Ditch Plain plan would not do, Abbey wrote, being "a modification of an old plan of a small, weak, and generally unsatisfactory house" and more expensive besides.⁶²

The Brant Rock station, which was built in 1892-93, was the third station built to plans that George R. Tolman, the Life-Saving Service's chief architect in the early 1890s, designed for a Shingle-Style station at Quonochontaug, Rhode Island, in 1891 (see Figure 37). Late in 1892, Tolman adapted the Quonochontaug design for a station that was built at Jackson Park on Lake Michigan for the World's Columbian Exposition in 1893 (Figure 38). Most notably, Tol-

60. Station Log September 16, 1933.

61. Letter from Superintendent of Construction to the General Superintendent, August 1, 1893, photocopy of original correspondence in CALO files.

62. Ibid.

man relocated the “storm clothes room” from a position between the “mess room” and the stair hall to a position on the opposite side of the mess room from the hall. The crew entrance, which was into the storm clothes room, was then at the gable end of the building and windows were changed accordingly. An historic photograph of the Quonochontaug building (see Figure 7) does not indicate a door on what corresponds to the southeast side of the Portsmouth station, suggesting that this change in the floor plan may have occurred even before the original Quonochontaug station was built. At the Portsmouth station, there is no evidence that there was ever a door at the southeast end of the stair hall, as indicated on the original Quonochontaug plans. It is not clear why this change to the plan was made, since it reduced light and air in the crew’s mess room.

A second station using the modified Quonochontaug design was built at Brant Rock, Massachusetts, around the same time that the Jackson Park station was under construction. It incorporated most of the features in the Jackson Park plans and became the

model for the station at Portsmouth. In form and architectural style, the Quonochontaug, Brant Rock, and Portsmouth buildings were almost identical (the Rhode Island station was destroyed by the great New England hurricane of 1938 and the Brant Rock station burned in 1967), and both buildings had the same number of rooms, each room configured in much the same way and, at least on paper, intended for the same use.

Although Abbey initially thought the addition of a porch was the only change to the Brant Rock plans and specifications that would be required, he outlined a few other changes in a letter to the General Superintendent on March 30, 1894 (see Appendix B for a copy of the Brant Rock specifications and Abbey’s letter outlining proposed changes). Most were relatively minor, e.g., allowing for sawn shingles rather than split or “shaved” shingles; specifying 4” rather than 1- 1/2” flashing “for the reason that 1- 1/2” flashings have been found insufficient to prevent leakage”; and changing the smaller boat room door from 6’ to 7’ wide in order to accommodate the “beach apparatus cart” that would be using it.⁶³



FIGURE 39. View of Portsmouth station about 1910, the earliest image of the station. The photographer was apparently standing on the “dam” that the crew built at the head of the creek in 1908. (CALO Coll. C-13)

Chronology of Development and Use

Abbey also thought that the design of the boat room doors “is not as satisfactory as it should be,” noting:

in such doors, leakage and damage occurs by the settling of water in the beads of the diagonal paneling, where it sets in the frame, and this in time causes discoloration and decay.⁶⁴

As noted above, the porch that the original Quonochontaug plan shows wrapping the gabled end of the building was apparently not constructed for the Quonochontaug or the Brant Rock stations. At the Jackson Park building, the porch was replaced by a balustraded deck without a roof. At Portsmouth, however, the full porch was constructed as shown on the original Quonochontaug plans, and all stations built to those plans after that time had porches as well.

The rooms in the Portsmouth station functioned more or less as designated on the Quonochontaug plans. On the first floor, in addition to a stair hall and “storm- clothes room,” where the surf men kept their slickers, boots, and other bad- weather gear, there was a small entrance hall that was used primarily by the Keeper and visitors; a kitchen with an adjacent pantry; a “mess room” or dining room; the Keeper’s private bedroom; and a large, three- bay, boat room. Doors and windows were in their present locations, but there was also originally a door opening from the kitchen directly into the mess room. That door was shown as a sliding or pocket door on the Brant Rock plans, but Superintendent Abbey proposed a conventional door.

A door, instead will be much better and prevent the necessity of passing through the vestibule when going from one of these rooms to the other, which tend, to keep the dining room cold. With a door as suggested the heat from the kitchen will suffice for warming the dining room except in very cold weather.⁶⁵

On the second floor were the crew’s quarters, which included a large open bunk room and eight small closets, each with a built- in chest of drawers. Also on the second floor were a “spare room,” which was used to accommodate overnight guests, and an

63. Letter from Superintendent of Construction to the General Superintendent, March 30, 1994, photocopy of original correspondence in CALO files.

64. Ibid.

65. Ibid.

unfinished “store room.” A conventional stair case to the attic was designed for the hall between these last two rooms, but at Portsmouth steep, ladder- like stairs were installed instead. The hall also featured a double- leaf trap door in the floor that allowed large objects to be hoisted up from the boat room below.

Original Exterior Finishes

Although the original boat room doors and some windows are now covered with plywood and all of the exterior shingles were replaced in 1980, the present building retains or replicates nearly all of the building’s original exterior finishes. Original exterior finishes included cedar shingles with metal ridge caps on the roof, cedar shingles on the walls, six- over- two double- hung sash, and tongue- and- groove flooring on the verandah or piazza, as it was sometimes called. (See the following section of this report, “Physical Description,” for details of these finishes.)

Original features that are no longer present are the wooden lattice that was originally used to close off the crawl space beneath the building and the wooden ramps that descended from the boat room doors (see Figure 39). There is no evidence that the building ever had shutters or blinds at the windows, but half screens at the windows and storm doors at all outside doors and at the door between the stair hall and the boat room appear to have been part of the building’s original construction.

The original exterior colors of the building are uncertain, although in the earliest photograph (c. 1910) the trim appears to be painted while the shingles appear to have been left untreated.⁶⁶ Specifications for the Brant Rock Life- Saving Station (1892) called for dark red window sash, with other “wood- work usually painted” to be “light red, made of Venetian red and yellow ocher and pure linseed oil.” The exterior of the boat room doors were to be “oil stained” and finished with three coats of “Pellucidite,” a type of varnish, while the shingles were “to be left in natural wood, no paint or oil.” The Portsmouth station may have been treated in a similar manner.

The Brant Rock specifications also called for wooden inclines at the boat room doors and built-

66. Historically, shingles were usually left untreated or were stained but were seldom painted.

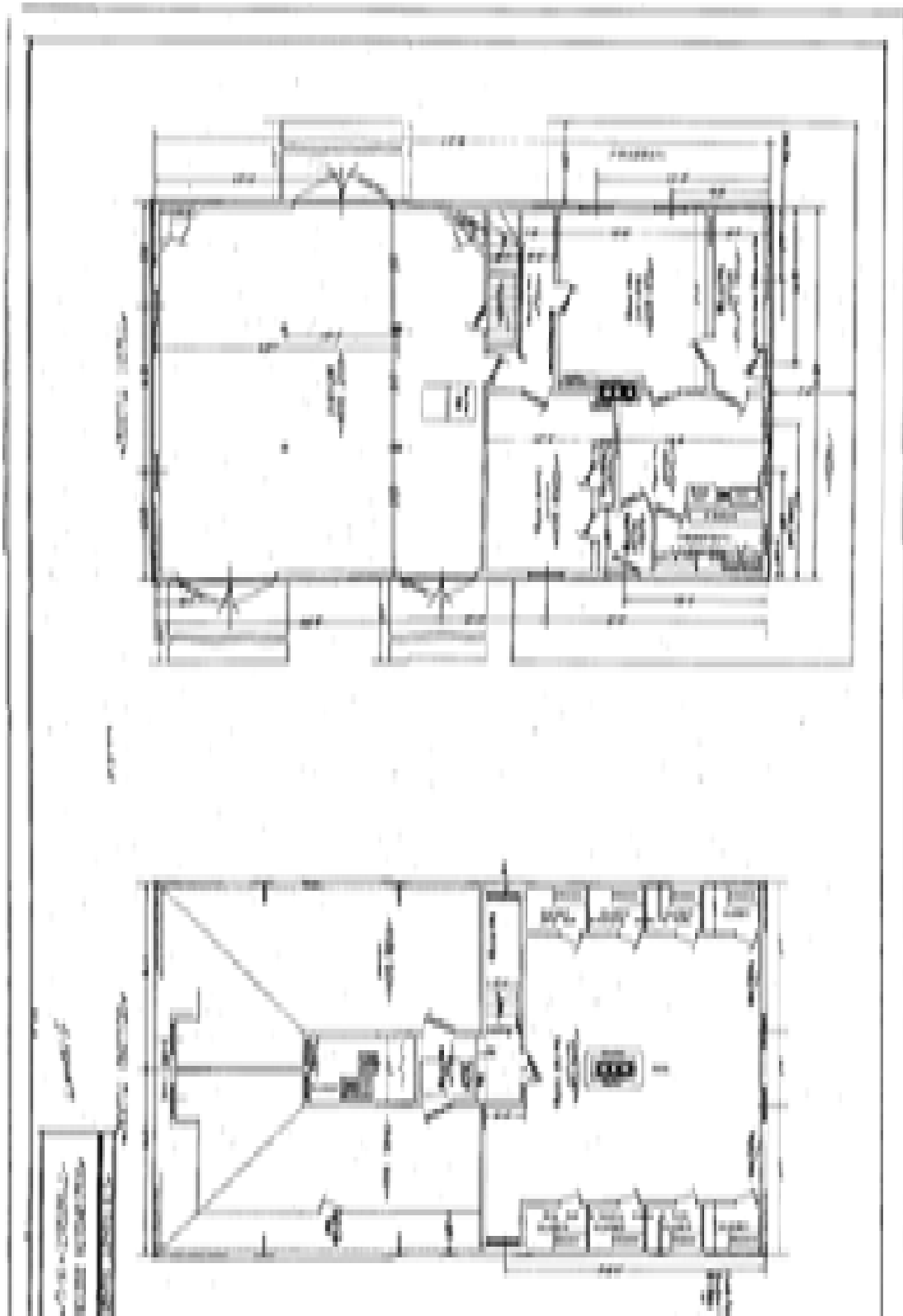

FIGURE 40. Undated plans for Portsmouth Life-Saving Station, perhaps 1916, but corresponding to the station's plans as it was originally constructed. (Record Group 26, National Archives and Records Administration, Philadelphia, PA)

Chronology of Development and Use

in wooden gutters. These features were constructed but no longer remain with the present building.

Finally, the Brant Rock specifications called for “a brick cistern to be built adjacent to the kitchen, outside the main building.” In spite of its rather awkward placement, the brick cistern at Portsmouth was probably part of the station’s original construction. It was to be built on a 6”- thick, concrete foundation, “4 feet of the height to be below the established grade, and the remainder above the same.”

Original Interior Finishes

Interior walls and ceilings were plaster on wood lath, with wooden wainscotting present in all rooms except the keeper’s room and the crew’s quarters, where there were only wooden chair rails,⁶⁷ and the spare room, where there was neither wainscot nor chair rail. The present tongue- and- groove flooring appears to be original, but that is not certain. It is a mixture of 2- 1/2”- wide and 3”- wide boards, but there is no evidence for extensive repairs or replacement.

Physical evidence shows that most of the interior woodwork was originally stained and varnished (“hard- oiled,” is the term used for “varnished” in the station logs). The Brant Rock specifications call for a “light wood stain, made of sienna and pure lin-



FIGURE 41. View of kerosene lamp parts, pumps, and ice tongs now stored in Room 203. These could have been used in the station. (T. Jones, NPS, 2005)

seed oil,” on most interior woodwork, but a cherry stain was specified for the interior of the window sash. All woodwork was to be finished with two (2) coats of ‘Pellucidite,’ which was apparently a type of varnish.⁶⁸ That included flooring, where even the boat room floor was apparently kept varnished.⁶⁹ Neither the Brant Rock specifications nor the station logs document the original finishes on the station’s interior plaster.

Other Original Interior Features

A number of other interior features are documented in the Brant Rock specifications. These include the three closets in the boat room and the mantle in the mess room. Other features that were probably built but that are no longer present in the Portsmouth station include a china cabinet in the Pantry (101), window seats at the dormer windows, and cherry-wood interior door knobs.

Lighting

For most of its history, the Portsmouth station was lit with kerosene lamps. Kerosene chandeliers might have been present in the mess room, but most likely all of the lighting was provided by table lamps. Parts of kerosene lamps are stored in the store room (Room 203) on the second floor, but it is not known if these were used in the station or came from another building.

Water

The plans (c. 1916) in Figure 40 indicate a sink with a hand- operated pump along the northeast wall of Room 102, which was the original kitchen, and although these are no longer present, they were probably original features. The Brant Rock specifications called for “‘Columbus’ wrought steel galvanized sink, 18 by 30 by 6 inches . . . with a brass screw drainer, complete, supported by a strong frame, left open below, with a wooden grooved draining shelf.” It is not clear if the pump now stored in Room 203 is an historic feature of the building. The building had no indoor bathrooms.

Heating

In addition to a wood- burning cook stove in the kitchen, heating was provided by coal- and wood- burning stoves.⁷⁰ The earliest plans of the building show only three flues in the chimney, which served

67. The plans in Figure 39 document the presence of a chair rail in the Keeper’s Room.

68. Brant Rock Specifications, p. 15.

69. E.g., station log, February 27, 1911.

stoves in the kitchen, the mess room, and the keeper's room. The plans also show a mantle shelf in the mess room and in the keeper's room. However, by the time the plans in Figure 40 were drawn, a stove was also present in the crew's quarters on the second floor, although the rest of the second floor remained unheated. Since there were only three flues in the chimney and since sleeping quarters were often unheated in the nineteenth century, it is likely that the stove in the Crew's Quarters was not originally present. The stoves were routinely put up in October or November and dismantled and stored in April or May.

Maintenance

In between rescue drills and actual rescues, the surf men were responsible for nearly all of the maintenance of the station, from daily housekeeping to routine repairs. Fortunately for the Portsmouth crew, the station's design greatly reduced maintenance, since the cedar shingles covering most of the building did not require painting.

Painting

Although there are references in the station logs to painting materials, including white lead and linseed oil, there has been no analysis of surviving paint on the existing building, and there is little definitive information on the building's painted finishes. However, as noted earlier, historic photographs and the station's log books prove that the exterior trim was painted and support circumstantial evidence in the Brant Rock specifications and historic photographs that exterior shingles were left unfinished.

Typically the station's "trimmings," windows, doors, and porch ceiling and floor were repainted every three or four years, generally in the spring or fall. Until pre-mixed paints began to be used in the late 1890s, the crew routinely mixed their own paints using white and red lead, pigments, and linseed oil. Outbuildings and fences were routinely white-washed. In 1910, the station's exterior trim was painted white, and historic photographs suggest that white trim was the norm throughout the remainder of the historic period.⁷¹

70. Station logs document periodic deliveries of coal and wood.

71. Station log, September 26, 1910.

A visitor to the island in 1921 published an account of his visit in which he described the life-saving station as "all white and green."⁷² This suggests that the exterior shingles might have been stained or possibly painted green by that time, but the writer might have only been describing the green paint that has been documented on the brick cistern and the porch ceiling.

The interior was less-frequently repainted, and with most of the woodwork stained and varnished (or "hard oiled," as it was called), maintenance was minimal. The station's log book documents painting of much of the plaster on the first floor in 1908, but there is no note made of colors used. However, in December 1918, twenty gallons of "straw paint" was delivered to the station, and it is likely that this was used for repainting the plaster walls and ceilings in 1919.

Of some interest is the use of "alabastine" on the plaster walls in the 1910s.⁷³ Advertised and "celebrated" as a "sanitary wall coating," alabastine was deemed "the finest substitute for kalsomine and wall paper yet discovered." Composed of calcium sulfate, a form of gypsum, the material was sold in powdered form to be mixed with paint.⁷⁴ The station logs document a few other aspects of the building's historic painted finishes, including the use of grey paint on the porch floor and on the boat room doors, which were originally stained and varnished.⁷⁵

Gutters

Gutters were always present during the historic period and were important not only for filling the cistern but also to provide some protection for the exterior walls, which the narrow eaves did little to shelter. The original gutters may have been built-in wooden gutters, as called for in the Brant Rock specifications, but in November 1899, the station log notes the receipt of gutters. That these were metal gutters is shown by the entry of June 14, 1900, which notes "tinner puts up new gutters." No doubt, these were the same roof-hung, half-round gutters shown in the 1910 photograph of the station.

72. Fred A. Olds, "The Barrier Reef," *The Orphan's Friend and Masonic Journal* (Oxford, NC), October 28, 1921.

73. Station log, May 5, 1910, and September 5, 1918.

74. See <<http://www.geocities.com/Heartland/Fields/4791/sep1881.html>>.

75. Station log, October 25, 1917; June 13, 1919.

Chronology of Development and Use

The harsh marine environment hastened deterioration of gutters, especially if they were not galvanized. By 1907, the gutters installed in 1900 were in need of repair, and they appear to have been replaced entirely in 1913, perhaps using galvanized metal since there is no further mention in the station log of gutter replacement.

Screens

As noted above, the station appears to have been fitted with wood-framed window screens when it was originally constructed. However, because their light-weight construction made them prone to storm damage and because the harsh marine environment took its toll on the screening itself, the window screens and screened doors required frequent repairs. In May 1910, the Keeper recorded that fifteen window screens and two screen doors, all that were in the station, had been condemned and were replaced.⁷⁶ At least some screens were replaced again in 1918.⁷⁷

76. Station log, May 26, 1910.

77. Station log, August 28, 1918.

Flooding

Although the building itself flooded only infrequently during the historic period, the entire site was and remains prone to flooding, often two or three times a year. Between November 1894 and December 1895, for example, the site was under water on four separate occasions. Water was nine inches deep inside the station in the wake of the San Ciriaco hurricane in 1899, and the station flooded twice in 1933, although there is no record of how much water entered the station at that time.⁷⁸

There were also several inches of water inside the station during Hurricane Dennis in 1999 and Hurricane Alex in 2004. Hurricane Isabel in 2003 was perhaps the worst, with some twenty-two inches of water inside the station at the height of the storm. Obviously flooding took its toll on the building, especially the plaster walls, parts of which were failing as early as 1903.⁷⁹ Whether or not there was material damage, these storms always left the sta-

78. Station logs document these amounts.

79. Station log, December 22, 1903.

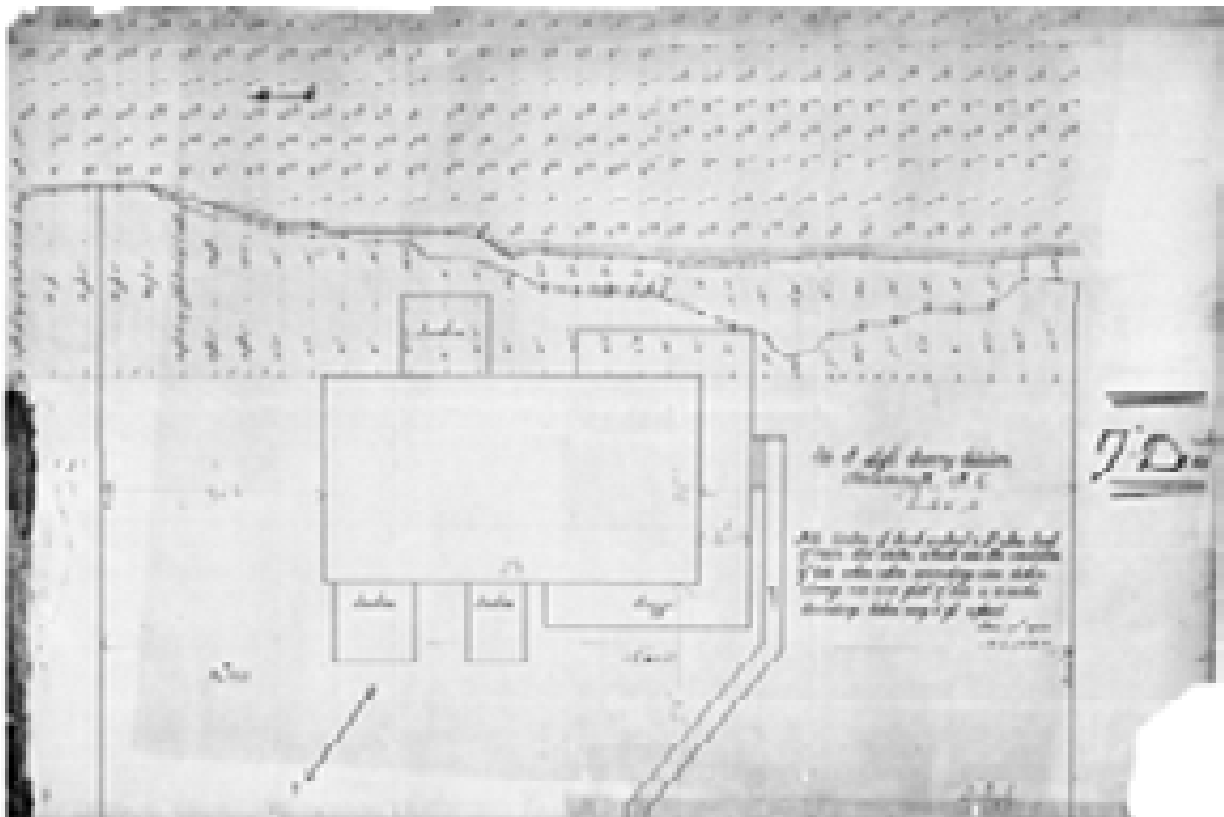

FIGURE 42. Plot map of Portsmouth Life-Saving Station in 1900. The walk leads to the oil house, which is not depicted on this map. Note that neither the summer kitchen nor the cistern yet exist. (RG 26, National Archives and Records Administration, Cartographic Division, College Park, MD)

tion's crew with a huge mess to clean up. In addition, while water did not always rise high enough to flood the station itself, the flooding caused significant erosion of the site, especially during the early years. In January and February 1896, the crew constructed a wooden breakwater along the creek, but in October of that same year, it was "washed down" by storm surge during a tropical storm.⁸⁰ The breakwater was damaged again in the 1899 hurricanes, and in November 1900, a nor'easter cut the bank of the creek to within nine feet of the station's walls. The breakwater was washed down a fourth time in the 1913 storm, and throughout this period, the Keeper noted in his log on several occasions that the crew was "hauling bricks and stone" to put around the station. Only after construction of the sea wall during World War I was it possible to stabilize the site.

Alterations

In addition to painting, routine maintenance, and repairs to storm damage, four significant building campaigns can be identified. The first came in the spring of 1908 when the "summer kitchen" was

80. Station log, January 16, February 3, 1896.

constructed. Additional construction occurred around the time the Coast Guard was created in 1915, which probably included alterations to the original kitchen or cook room, as it was called. A third construction campaign can also be identified when most of the interior plaster was replaced, which probably occurred when the station was reactivated in 1942. The final series of significant alterations or repairs came during the early years of NPS ownership of the site.

Documentation

Research for this report included a thorough review of the station's log books, which begin in September 1894 and continue until the station's closure on June 1, 1937. Keepers were instructed to note any activity at the station, and most of the alterations discussed below are documented in the station log books. However, Keepers generally omitted the work that was performed by contractors and that did not involve the station crew's labor. As a result, uncertainty remains as to precisely when some changes were made.

However, historic drawings from the 1890s and early 1900s as well as photographs taken between about 1910 and 1950 help in dating some alterations



FIGURE 43. View north of Portsmouth Coast Guard Station, dated July 10, 1917. Barely visible at extreme left are the station stables, with the 1908 kitchen in the foreground and the 1894 oil house at center. (CALO Coll. A-67)

Chronology of Development and Use

as do the characteristics of certain building materials used in alterations and additions. In addition, the present study has benefitted from historic structure reports recently completed for the life-saving stations at Cape Lookout and Bodie Island. Those studies also included research in the station log books and provide useful parallels for interpretation of changes at the Portsmouth station.

1895-1915

In addition to alteration and relocation of outbuildings, routine maintenance, and repair of storm damage, the Life-Saving Service made or began making some significant changes to the station prior to World War I. These included construction of a separate kitchen building and replacement of the original door locks.

Kitchen. A significant change for the Portsmouth station was construction of a one-room “summer kitchen” just west of the station house, which probably occurred in 1908. When the Cape Lookout station was built in 1887, its kitchen was also inside the station house, but there and elsewhere the Life-Saving Service soon found that in a Southern climate, at least, an outside kitchen was a necessity. A separate kitchen building was built at Cape Lookout in the fall of 1892, but the Portsmouth station did not get a summer kitchen until 1908. The new summer kitchen is depicted as part of the 1909 revisions to a 1903 plot of the life-saving station in which the kitchen was not present. The only large-scale construction projects that could have included the kitchen prior to that time occurred in late spring and summer of 1908. The station logs suggest that the original kitchen, or “cook room,” continued to be used during the winter, and perhaps other times as well.

Sewer Lines. Construction of the kitchen included installation of new sewer lines. On July 6, 1908, the keeper noted that the crew had spent the day “taking up and putting down the sewer pipe that Mr. Shull put down in July.” Keeper McWilliams went on to explain in the station log book:

He put it down two feet lower at the cistern than it was at the pipe that lead from the sink to the cistern pipe and the dirty water that come from the sink and the salt water on high tide would run down at the lower end of the pipe to the cistern and ruined the water in the cistern.

Sewer lines are depicted on the 1909 plot of the station (Figure 45) and appear to indicate that, in addition to water service to the summer kitchen, there were at least two sinks inside the station. One was located around the west corner of the kitchen (Room 102) and it appears that another was located in the storm-clothes room (Room 103), giving the crew their first wash room inside the building.

Installation of a wash room inside the station was apparently part of an ongoing effort by the Life-Saving Service to provide indoor wash rooms at all stations. In October 1903, an inspector with the Life-Saving Service visited the station at Little Kinnakeet and noted “that there is no washing place provided for the crew (an omission that is now being remedied in many stations, old and new).” At Little Kinnakeet and at Portsmouth, the remedy was to create a wash room in the storm clothes room that included “a sink large enough to take two movable wash basins, with pump to supply the water thereto, be placed along the closed end of the storm clothes room.”⁸¹

Door Locks. Journal entries document replacement of all of the door locks in the station in 1913. In June of that year, the keeper recorded in the station log receipt of “18 door locks with brass knobs” along with several thousand feet of lumber.⁸² It is not clear for what purpose the lumber was intended, but the locks were clearly for the station itself, since the building has eighteen mortise locks, not including the simple latches on the nine closet doors on the second floor and the thumb latch on the door to the attic. The station log records that the crew installed these new steel locks on August 20, 1913. The locks were manufactured by Yale & Towne Manufacturing Company of Stamford, Connecticut. Why it was necessary to replace the original locks is not known, but it might have been done simply as an upgrade from common rim locks and the wooden door knobs that were installed when the station was first built.

1915-1946

The Coast Guard completed some of the projects that were begun by the Life-Saving Service, including construction of the long concrete sea wall that

81. Quoted in David Wallace, “Historic Furnishings Report, Little Kinnakeet Life-Saving Station” (NPS, 1991), p. 35.

82. Station Log, June 6, 1913.

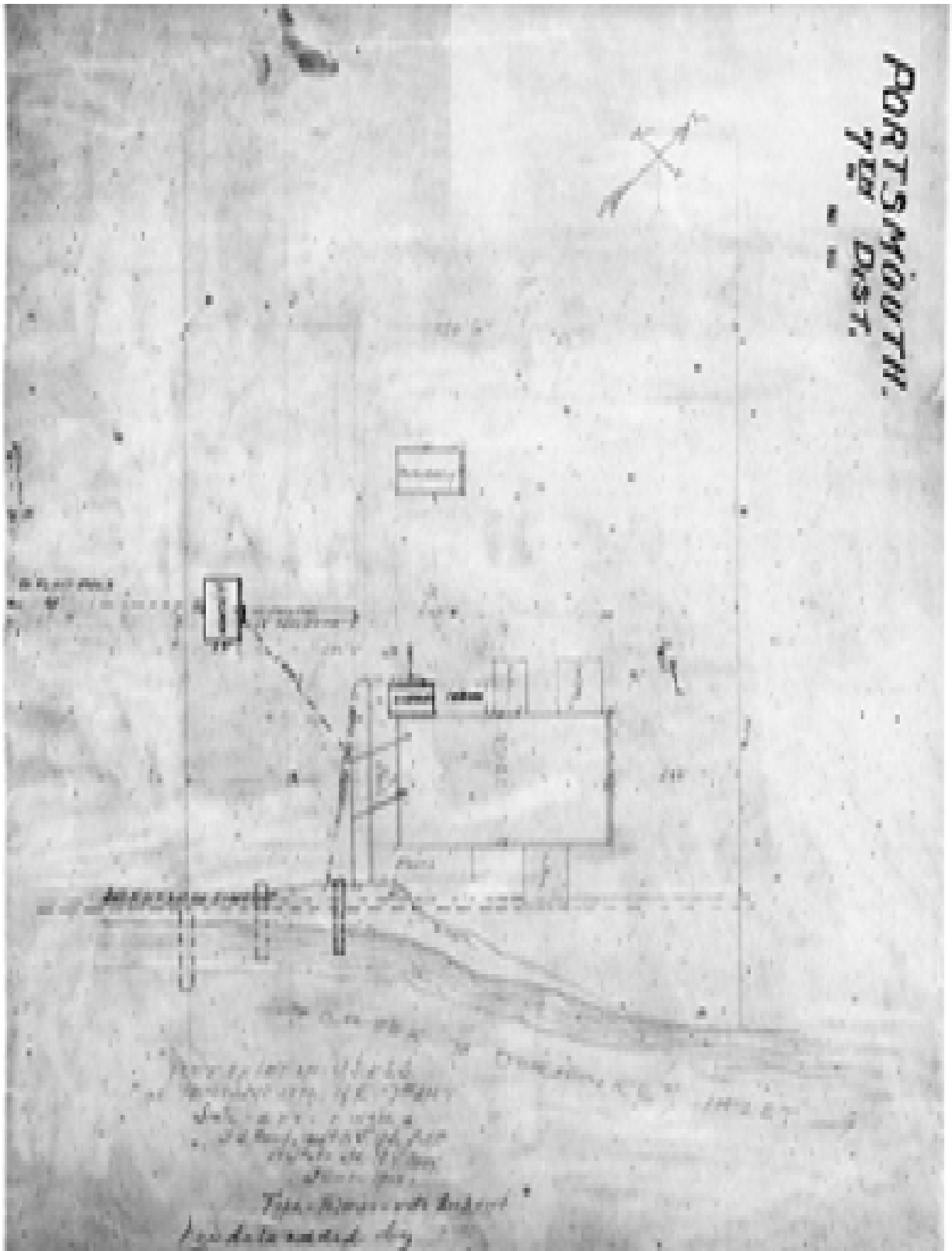

FIGURE 44. "Plot of Lot of U.S. L-S.S. at Portsmouth, N. C.," June 1903 with revisions dated July 26, 1909. (National Archives and Record Center, Cartographic Division, College Park, MD)

Chronology of Development and Use

was begun in 1914 north and east of the station. In addition, the Coast Guard appears to have made a number of other improvements at the Portsmouth station, as it did at many other old life-saving stations. Station logs indicated that, by the end of World War I, washrooms and telephone service had been added to the station and that new paneling had been installed in the original “cook room” and the adjacent store room. At least some damage done by the 1933 hurricanes was not repaired before the station closed in 1937. When the station was reactivated in 1942, nearly all of the old plaster walls and ceilings were replaced.

Boat Ramps. Along with construction of the concrete seawall, replacement of the original wooden ramps to the boat room doors was planned by the Life-Saving Service and completed by the Coast Guard. All three ramps were constructed of concrete over a shell and sand fill that the crew carried from elsewhere on the site. In addition to the ramps, concrete walkways around the station and to the summer kitchen were also poured around the same time.⁸³

Telephone. Although the Portsmouth station was apparently never wired for electricity, a telephone

83. Station Log, various dates between November 1913 and March 1918.

cable was laid across Ocracoke Inlet to Portsmouth and telephone lines were strung to Core Bank station in the summer of 1917.⁸⁴ Two telephones were installed. Most likely, one telephone was located in the lookout and the other in the keeper’s room.

Old Kitchen and Pantry. The earliest floor plans of the building (see Figure 40) date no earlier than 1915⁸⁵ and depict the kitchen and pantry very much as they are shown on Tolman’s original plans for the Quonochontaug stations in 1893. However, in 1918, the first references to a “surf man’s wash room”⁸⁶ and a “keeper’s wash room”⁸⁷ appear in the station log books. Although neither of these rooms is depicted on the 1915 plans, a wash room (but no water closet) had apparently been created in the storm-clothes room (Room 103) in 1908.⁸⁸ Sometime between 1915 and 1918, the sink was removed from the west corner of the original kitchen (Room 102), and it or a different sink was installed in the pantry (Room 101) to create a wash room for the Officer in Charge.

84. Station Log, March 15, October 3, 1917.

85. Although the plans are undated, they are labeled “Coast Guard, Portsmouth Station,” and so must post-date the founding of the Coast Guard in 1915.

86. Station Log, July 18, 1918.

87. Station Log, October 25, 1918.

88. This assumption is based on the sewer lines depicted on the 1909 drawing in Figure 45.



FIGURE 45. View east of station, 1916, one of few images showing the 1894 wreck pole, right, and the 1913 steel storm-warning tower. (CALO Coll. B-99)

The addition of these facilities to the station must have coincided with the installation of new V- joint paneling on the walls and ceilings of both rooms, as suggested by the fact that there is no evidence on the present paneling for the kitchen sink, counters, and other features depicted in the 1915 plans, while there is clear evidence for the presence of a bathroom sink and toilet in the old pantry. In addition, the use of V- joint boards in place of the original beaded tongue- and- groove boards echoes similar material differences in the Cape Lookout Life- Saving Station where bathrooms are known to have been added and finished with V- joint paneling during or shortly after World War I.

In the summer and fall of 1918, the crew spent several weeks removing varnish and refinishing walls, ceilings, and floors. References to “sandpapering walls and ceiling in keeper’s washroom”⁸⁹ suggest that his washroom was, in fact, the old pantry, since that is the only small room with a paneled ceiling. It is unclear if the old kitchen continued to be used for cooking, but it probably did not. Log book entries suggest, but do not prove, that the room was used as an office for the officer in charge of the station. This

89. Ibid.

suggestion is supported by the absence of any evidence in the present room for a sink or other features clearly related to the room’s use as a kitchen. In addition, installation of the V- joint paneling must have included the closure of the door between the Kitchen and the Mess Room, since there is no evidence in the present wall to indicate that a door opening has been closed at that location.

Metal Cistern. In March 1921, the station’s crew spent two days erecting a “water tank,” which must have been the round, metal tank that stood until recently at the end of the porch on the southeast side of the building.⁹⁰ While it functioned like a cistern by collecting rainwater from the station’s roof, this tank was probably used to store water for fire-fighting and not for human consumption. The tank was recently taken down and put in storage.

Gun Cabinet. The cabinet in the north corner of Room 101 appears to have been added after installation of the V- joint paneling since it was built over the chair rail that surrounds the room. It was clearly built as a locker for rifles, and probably ammunition and other guns as well. In October 1918, the station

90. Station Log, March 14-15, 1921.



FIGURE 46. The Portsmouth Coast Guard Station in 1942. At center, note water tank that was installed in 1921 and, at right, the station’s privy. (CALO Coll. B-26)



FIGURE 47. Portsmouth Coast Guard crew moving a sidewalk, perhaps in conjunction with construction of the addition to the summer kitchen, 1942. (CALO Coll. B-40)



FIGURE 48. View of the Coast Guard's mounted beach patrol at Portsmouth in 1942. The summer kitchen was painted white after the addi-



FIGURE 49. View of Portsmouth Coast Guard Station around the time it was permanently decommissioned in 1946. (CALO Coll. G-18)

log records receipt of “rifle, Springfield, belt, sling, bayonet, scabbard, and canteen- - 240 cartridges.”⁹¹ Other rifles could have been issued around the same time, but not until 1930 do log entries clearly indicate that rifles had been issued to most, if not all, of the station’s crew.⁹² Most likely the rifles were issued as part of the government’s stepped- up efforts in the spring of 1925 to enforce the Volstead Act which prohibited the manufacture, transport or sale of alcoholic beverages.

1933 Hurricanes. There is no record of precisely what damage was done to the station by the 1933 hurricanes, but it must have been considerable. Water rose high enough during both storms to flood the first floor of the station, which would probably have caused significant damage to the plaster walls if nothing else. At the height of the storm, the officer in charge recorded later, the building was so buffeted by the wind and the accompanying storm surge that it was “expected to go away.”⁹³ The building held, but recovery was slow. Phone service was not restored until January 1934, and it was not until April 1934 that the Coast Guard was able to make a full assessment of the damage. Some repairs must have been made, but even so, when Julian Gray assumed command of the Portsmouth Coast Guard Station in January 1935, he immediately noted in the station log book that “buildings are in need of repair due to damage done by storms,” an entry that was repeated routinely until the station was closed on June 1, 1937.⁹⁴

“Rock Lath” Walls and Ceilings. Installation of the existing plaster walls and ceilings in the station could have occurred prior to the station’s deactivation in 1937, but that does not seem likely. While “rock lath” became popular in the 1930s, it is almost certain that the station would have been vacated in order for the old plaster walls and ceilings to be removed and replaced, and there are no entries in the station’s logs that would indicate that this happened. Most likely, these and other repairs were made when the station was re- activated in 1942. At that time, all of the original plaster and wood lath was removed from walls and ceilings throughout the building except in the closets. Walls and ceilings

91. Station Log, October 10, 1918.
 92. Station Log, August 2, 1930.
 93. Station Log, September 16, 1933.
 94. Station Log, January 23, 1935.

were then finished with the plaster on rock lath that remains in the building today.

Gypsum or rock lath is a manufactured plaster board, usually 16 inches by 48 inches and $\frac{3}{8}$ of an inch thick. It became popular in the 1930s as a less expensive alternative to wood lath, being much less labor intensive to install. Nailed directly to the wall studs, it received two coats of plaster, with the rock lath replacing both the wood lath and the brown coat in the original system. The first coat was a cement plaster about $\frac{1}{4}$ inch to $\frac{3}{8}$ inch thick. The finish coat was a hard finish-grade plaster approximately $\frac{1}{8}$ inch thick. Rock lath can sometimes be identified by a characteristic pattern of cracks that may be visible in ceilings and walls. In the present building, the back sides of the lath are also visible in the attic and a few other places.

Screened Porch. Another change that has not been dated, but that historic photographs suggest was made when the station was reactivated in 1942, was screening of the porch on the southwest and southeast sides of the house.⁹⁵ Probably at the same time, 1" by 6" boards were used to close off the area

beneath the porches, replacing the lattice that was used originally but which had probably been damaged and replaced on more than one occasion.

Post-World War II

The Portsmouth Coast Guard Station may have sat vacant for a time after it was declared surplus in 1946. Its condition certainly deteriorated, as evidenced by photographs from the period, but by the mid- 1950s it was being used as a hunting club and at least some repairs were being made. The old wood-shingled roofing was recovered with white asphalt shingles in the late 1950s or early 1960s. Around the same time, the porch wrapping the southeast side of the building was removed, apparently to accommodate vehicular parking, and the old WWII- era screening was entirely replaced on the remainder of the porch.

In 1978, the wood shingles cladding the exterior of the building were replaced along with repair or replacement of damaged and missing window sash.

95. Porches at the Cape Lookout station were screened around the same time.



FIGURE 50. View of old Portsmouth Coast Guard Station when it was being used as a hunting club, c. 1956. (CALO Coll. B-35)



FIGURE 51. View of old Portsmouth Coast Guard Station in 1974. (CALO Coll. F-203)

Screening was also removed from the front porch, and the porch flooring was replaced. Later, when the building was being used to house park personnel (1980- 1990), a shower was installed in the west corner of the old pantry (Room 101), temporary wiring was installed, and urinals and other fixtures were removed from the old storm clothes room (Room 103). Although the building has been flooded on

numerous occasions in the past, the storm surge during Hurricane Isabel may have set a record, with 22" of water measured inside the station. Damage was perhaps the most severe of any suffered by the station, with parts of the wall at the east end of the building destroyed and much of the northeast quadrant of the boat room floor torn loose.

Portsmouth Life-Saving Station Chronology	
	Unless otherwise noted, quoted material is from the station's log books.
30 September 1894	First entry in journal of Portsmouth Life-Saving Station
3 November 1894	First entry indicating presence of a crew and full operation
12 April 1895	Nor'easter sends tide "all around station"
13 December 1895	Tide all around station, "highest in three years"
3 February 1896	Completed building breakwater east of station"
August 12, 1896	Completed building stables
October 10, 1896	Tide all around station from Category 2 hurricane at sea
October 11, 1896	Oil and coal house "tore up" by storm; breakwater east of station and part of fence "washed down"
October 29, 1896	Crew rebuilding breakwater
February 26, 1897	Crew completes boat house "on outer beach"
April 12, 1898	Island underwater from nor'easter
August 16, 1899	Category 3 San Ciriaco hurricane strikes Outer Banks, putting island under water, washing down fence, and causing boat house at hill to settle in the sand
August 17, 1899	Nine inches of water in station, "stables gone with horses in them," two families rescued and brought to station
October 30, 1899	Category 2 hurricane strikes south of Wilmington, washes down part of breakwater
November 23, 1899	Received gutters and lumber for cart house and walkway
February 24, 1900	Asst. Superintendent of Construction supervising construction of watch house
March 1, 1900	Nor'easter puts tide all around station and washes over breakwater damaged in October 1899 storm, cutting bank within 9' of station on east side
June 2, 1900	Crew "fixing boat room doors"
June 17, 1900	"Tinner" finishes installation of new gutters
May 23, 1901	Men puttying windows and painting "trimmings" on station
December 22, 1903	"A piece of plastering fell from station wall about the size of 7 inch by 7 ft in length"
January 5, 1904	"A piece of plastering fell from station wall size about 2-1/2 by 13 ft"
March 12, 1904	In answer to standard entry "Is the house in good repair?," keeper begins entering "fair" instead of "good"
May 17, 1904	Crew cleaned out cistern
December 18, 1904	Crew hauling rocks and bricks to put at east side of station
December 30, 1904	Mr. Henry E. Davis inspects "condition of this station Barn & etc."
May 22, 1905	Crew engaged in putting on hard oil finish in Keeper's room and dining room
May 23, 1905	Crew "finished putting on hard oil finish down stairs"
May 27, 1905	Crew putting rocks and turf at south corner of station
October 1-2, 1906	Water around station
February 16, 1907	Journal notation that "porches, windows, stables, gutters, etc." need repair

Chronology of Development and Use

Portsmouth Life-Saving Station Chronology	
March 9, 1907	Journal note that "general repairs" are needed
May 24, 1907	Crew put stone on each side of station
August 11, 1907	"Capt. Newcom visited station and inspected it and barn for repairs"
May 27, 1908	"Mr. George T. Hale has arrived to begin work on station." which probably included construction of the summer kitchen
May 29, 1908	"Crew saved about \$250 worth of lumber that belong to Mr. Shull the contractor who is to repair this station"
August 6, 1908	Crew "taking up and putting down sewer pipe that Mr. Shull put down in July. He put it down 2' lower at the cistern than it was at the pipe that lead from the sink to the cistern pipe and the dirty water that come from the sink and the salt water on high tide would run down at the lower end of the pipe to the cistern and ruined the water in the cistern."
August 27-29, 1908	Ground underwater around station
September 3, 1908	Crew finish putting up "yard fence"
September 7, 1908	Crew painting "keeper's room"
September 9, 1908	Crew painting "cook room"
September 12, 1908	Crew painting "dining room"
September 14, 1908	Crew "putting on hard oil finish down stairs"
September 17, 1908	Crew "hard oil boat room floor"
December 7, 1908	Crew hauling sand to fill in at northeast corner of station
December 28, 1908	Crew hauling stone and brick for northeast corner of station
March 1, 1909	Crew paint "piazza floor"
March 16-20, 1909	Crew paint windows on station
March 23-26, 1909	Crew paint "trimmings" on station
May 10, 1909	Crew landing lumber for station
February 5, 1910	Crew finishes building new privy
April 4, 1910	Crew working on window screens
April 5, 1910	Crew painting water closet and working on window screens
April 6, 1910	Crew making door screens
April 9-13, 1910	Crew working on and painting window screens
May 5, 1910	"Putting alabastin on lower walls"
May 28, 1910	Sandpapered and oiled boat room floor
May 31, 1910	Hard oiled keeper's room
Aug-Sept 1910	Exterior trim painted white
October 3-4, 1910	Crew painting overhead in piazza
October 26, 1910	Painting floor of piazza
February 11, 1911	Asst. Supt. of Construction T. J. Lothar arrived to see about building a boat house
February 27, 1911	Hard oil boat room floor and keepers room
April 17-18, 1911	Painting windows on station

Portsmouth Life-Saving Station Chronology	
November 15, 1911	Hard oiled boat room floor
March 7, 1912	Crew hard oil lookout
March 9, 1912	Crew "engaged in hard oiling in their setting room"
March 21, 1912	Crew "put hard oil on doors and trimmings on second floor"
March 24, 1912	Crew "put hard oil on siding in store room"
April 5, 1912	Crew painting trimmings in station
April 13, 1912	Crew painting porch floors
April 19, 1912	Crew paint cistern
May 21, 1912	Received 16 window shades
February 21, 1913	Received gutters for station
March 26-27, 1913	Crew installs gutters on station
April 7, 1913	Crew finishes painting windows
April 1913	Painted trimmings on station and outbuildings
April 22, 1913	Received "one steel storm warning tower complete"
April 28-29, 1913	Crew erects storm warning tower
May 12, 1913	Crew paints walls of the setting room on first floor
June 6, 1913	Received six painted window sash; 1000' 2 by 4 by 16'; 4000' of 1 by 6 by 16; and 18 door locks with brass knobs
August 20, 1913	Crew install locks on station doors
September 2-3, 1913	Hurricane blew off top of kitchen chimney, turned over water closet, washed away part of sand fence and jetty at creek
October 14, 1913	Crew plastering setting room and work on watch house
November 18, 1913	Received 184 bls of Portland cement, 1400' 1x6x16, 610' 2x4x16, 100 lbs 8d galvanized nails, and one sidewalk marker (or maker?)
December 17-18, 1913	Mason rebuilding kitchen chimney
May 1914	Crew painting trimmings and windows on buildings
October 5, 1914	Supt. of Construction John S. Randall arrives
October 9, 1914	Keeper takes Randall to Hatteras Inlet Station
January 12-14, 1915	Crew assists Mr. Latham with "concrete wall"
Jan-March, 1915	Continuing work on concrete breakwater
February 26-27, 1915	Crew work on sewer pipe from kitchen to creek
May 1915	Crew painting trimmings on station
May 9, 1915	Crew hard oil stairs
May 15, 1915	Crew paints gutters
May 21, 1915	Crew paints "U. S. Coast Guard" on boats and on station roof
August 1915	Several days of work taking up old walks and pouring concrete walks
September 14, 1915	Crew working on "station walks and Inclined" [sic]

Chronology of Development and Use

Portsmouth Life-Saving Station Chronology	
September 15, 1915	Crew work on incline on east side of station
September 24, 1915	Crew working on "molds" for inclines and repairing door sill in boat room
September 27-28, 1915	Crew working on concrete forms
September 29, 1915	Crew haul sand to fill in incline
October 19, 1915	Crew finishes work on concrete walks
October 1915	Work on concrete breakwater continues throughout the month
January 3, 1916	All of concrete and rebar used up, but 103' of the wall are still not done
January 5, 1916	Oiling boat room floor
March 6-7, 1916	Crew measuring and surveying station
May 8, 1916	Crew repairing old screens
October 3, 1917	Two telephones placed in operation at station
July 15, 1918	Removed varnish from dining room of station building
July 18, 1918	Crew prepare woodwork in surf man's wash room and the dining room for varnish
August 20, 1918	Varnish lookout and stairs
August 28, 1918	Dining room walls prepared for painting; put in new screens
September 5, 1918	Painted walls of plastered rooms on lower floor with albastine
September 6, 1918	Crew varnish dining room of main building; paint plastered walls of dining room
September 11, 1918	Crew remove varnish from doors on second floor
September 12, 1918	Crew remove varnish from doors and walls in surf man's room
September 25, 1918	Crew paints porch floors
October 2, 1918	Crew removes varnish from keeper's bedroom
October 9, 1918	Crew paints window screens
October 10, 1918	Crew removes varnish from keeper's room
October 11, 1918	Crew prepares floor for paraffin oil
October 13, 1918	Crew removes varnish from keeper's office
October 15, 1918	Crew removes varnish from keeper's room
October 16, 1918	Crew removes varnish from keeper's office
October 18, 1918	Crew remove varnish from walls and ceiling of keeper's room
October 20, 1918	Crew remove varnish from keeper's office
October 25, 1918	Crew sandpaper ceiling and walls in keeper's wash room
October 28, 1918	Crew cleaning floor of keeper's room
October 30, 1918	Crew cleaning and hard oil keeper's room
October 31, 1918	Crew varnish keeper's room
November 1, 1918	Crew polishing floor in keeper's room
November 6, 1918	Crew putting hard oil in keeper's room
November 15-16, 1918	Crew remove varnish from interior of Kitchen

Portsmouth Life-Saving Station Chronology	
January 21, 1920	Crew repair pipes leading from cistern to sink in surf man's wash room "bursting during recent freeze"
May 1920	Crew painting windows, screens, trimmings on station and outbuildings
March 7, 1921	Crew work on water tank
March 14-15, 1921	Crew work and finish water tank
September 27, 1924	Rcd. 11 pcs 6x6x16, 6 pcs. 6x6x12, 15 pcs 3x6x12, 10 pcs 3x6x16, 18 bundles of flooring
August 1931	Crew work on repairing "base" of station building
Feb-March 1932	Crew paint interior of station
Dec 1932	Crew repairs porch
March 20, 1933	Truck transferred from Cape Lookout station
June 1, 1937	Station decommissioned at sunset
1942	Station reactivated during World War II; interior walls and ceilings replastered; some outbuildings removed
c. 1943	Addition to summer kitchen; porches screened
March 1946	Coast Guard conveys station to War Assets Administration
1956	Brandt Rock Gun Club begins occupying the station
1960s	Station re-roofed; part of porch removed; remainder of porch re-screened
1977	Station becomes part of Cape Lookout National Seashore
1978	Station listed on the National Register as a contributing structure in the Portsmouth Historic District; exterior of station rehabilitated
c. 2000	Water tank (1921) dismantled and stored
September 2003	Hurricane Isabel puts 22" of water inside the station and causes significant damage at the northeast end of the boat room

Chronology of Development and Use

Physical Description

Located near the northern tip of Portsmouth Island perhaps twenty feet from the bank of a small inlet known as Coast Guard Creek, this Shingle- Style building was originally constructed in 1894 as a United States life- saving station. In 1915, it became part of the newly organized United States Coast Guard. The station was decommissioned and vacated in 1937, reactivated briefly during World War II, and used as a hunting lodge after the war.

Although the building has retained most of its original character, there have been a number of alterations since it was originally constructed, including installation of bathrooms, which were not present in

the original building, and replacement of nearly all of the interior plaster and exterior shingles. The building has suffered frequent damage from tropical storms, hurricanes, and nor'easters, with flooding of the station interior on several occasions. The station underwent a major restoration in the 1980s.

A site plan, floor plans, and selected molding profiles can be found at the end of this section.

Set on wooden pilings less than two feet above grade, the building is wood- framed, one- and- a- half stories high, and has a steep roof that is gabled



FIGURE 54. View north of Portsmouth Life-Saving Station, with kitchen at left and stable beyond. (NPS, 2005)

Physical Description



FIGURE 55. View of ramp to smaller boat room door on northwest side of building. (T. Jones, NPS, 2005)



FIGURE 56. View of deterioration on ramp to small boat-room door. (T. Jones, NPS, 2005)

at the southwest end, hipped at the northeast end, and pierced by three dormers. A hipped- roof lookout or watch tower rises above the northeastern end of the building and a one- story, hipped- roof porch wraps the southwest end of the building on three sides. The entire structure is clad in the wood shingles that define the architectural style.

Associated Site Features

Mostly turf covered, the site contains three historic buildings, all of them wood- framed and constructed in the late nineteenth or early twentieth centuries. In addition to the station house itself, there is the so- called “summer kitchen” located a few yards west of the station house and probably contemporaneous with the station itself. A stable, which is probably the same “barn” constructed by the crew in 1928, is located several dozen yards northwest of the station house. The kitchen house has been adapted as a part- time residence for park volunteers and is in excellent condition. The stable, which is used only for storage, is in fair condition. Adjacent to the stable are a series of pilings that mark the site of an historic boat house.

Also significant to the site are several historic concrete features, all of which date to the early twenti-



FIGURE 57. View southwest of station (T. Jones, NPS, 2005)

eth century. Concrete walkways run a few feet off the southwest and northwest sides of the building and also run to the kitchen house. All of these features were constructed by the station crew in 1915. In addition, a concrete seawall runs for several hundred feet along the west and northwest sides of Coast Guard Creek, and a concrete ramp descends to the water level through the sea wall about a hundred feet east of the station house. These features were also constructed by the crew, beginning in 1915 but not completed until January 1918.

Masonry

In addition to the concrete site features, there are masonry features associated with the building itself. These include three concrete boat ramps, a brick cistern, and a brick chimney stack.

Boat Ramps

Three concrete ramps descend to the ground from each of the boat-room doors, two on the northwest side of the building and one on the southeast side. All of them are poured concrete over sand fill, constructed by the station crew in 1915. The bases of these ramps were constructed using a very coarse aggregate composed primarily of shells, with the base then finished with a layer of conventional, sand- aggregate concrete about 1" thick. The finish

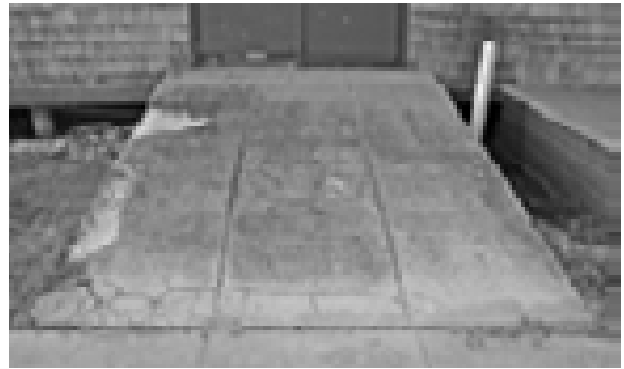

FIGURE 59. View of ramp to Boat Rooms doors D-5. (T. Jones, NPS, 2005)



FIGURE 60. View of southeast side of chimney. (T. Jones, NPS, 2005)



FIGURE 58. View southeast. (T. Jones, NPS, 2005)

Physical Description



FIGURE 61. View east of cistern. (T. Jones, NPS,

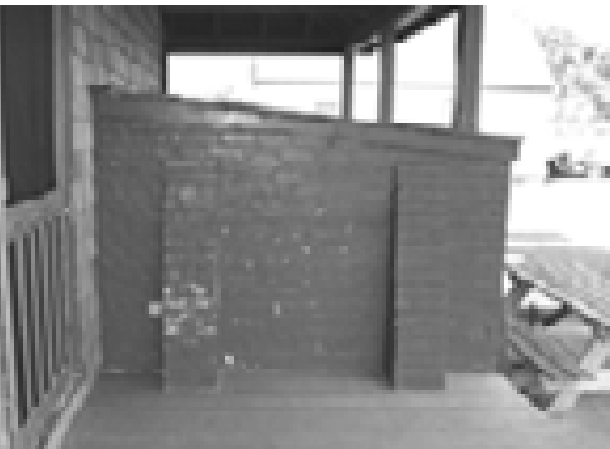

FIGURE 62. View southwest of cistern. (T. Jones, NPS, 2005)



FIGURE 63. View west under boat room. (T. Jones, NPS, 2005)

layer on all of the ramps was poured with expansion joints, and the two ramps on the northwest side of the building were finished with large grooves, apparently to provide traction when the boats were pulled up into the boat room.

Condition: The ramp from the easternmost door on the northwest side of the building is basically sound, but the finish layer of concrete on the other two ramps is spalling away from the base along part of the edges of the ramps.

Chimney

A brick chimney stack, which appears in good condition, rises from the ground through the roof ridge near the center of the southwestern half of the building. There are certainly two and possibly three flues within this chimney. None of the flues served a conventional fire place since the building was designed to be heated by wood- or coal- burning stoves. The stack is around 24" by 48" at the first floor, narrowing to 17" by 42" as it rises through the attic and the roof ridge.

Condition: The chimney stack is only visible in the attic and above the roof. In the attic, the brick has been stuccoed, and the stucco remains mostly intact and in good condition. Above the roof, the original chimney stack appears to remain intact, although the original stepped flashing has been replaced.

Cistern

The porch roof on the northwest side of the house shelters a large, painted, brick cistern that is around 8' by 13' in plan and rises about five feet above the porch floor. The brick walls are reinforced by a series of seven brick buttresses that taper from bases that are about a foot square. The slanted top of the cistern is closed by a wood- framed cover finished with a deck of 1" by 3" tongue- and- groove boards. There is a small hinged hatch large enough for a body to enter when the cistern needed cleaning. A pipe from the building's gutters originally fed through a four- inch hole near the top of the northwest side of the cistern. A galvanized pipe, partially encased in concrete, is located against one of the buttresses on the northwest side of the cistern, but its original function is unknown.

Condition: The cistern appears to be in sound condition, but downspouts from the gutters no longer

keep it filled. The wooden cover is in fair condition. The hatch that provides access to the interior of the cistern is nailed shut, and the condition of the interior of the cistern was not inspected.

Foundation

The building rests on a foundation of wooden pilings, 10" to 12" in diameter and set about six feet apart around the perimeter of the building. Two rows of pilings, also around six feet apart, run northeast to southwest beneath the boat room and appear to continue to the south west end of the building. The pilings appear to be mortised into the sills, with the sheer weight of the structure keeping the structure in place.

Condition: There is no indication that the pilings are not original to the building, and many of them have lost a considerable amount of wood, mostly due to erosion from sand- laden water that periodically sweeps the site.

Structure

The building is wooden and balloon framed using regularly dimensioned circular- sawn lumber and machine- cut nails. Joists are generally set 24" on centers and range from 4" by 12" in the boat room to 2" by 8" (full dimension) in the second floor ceiling. First floor joists are cut so as to set into mortises in the sills and also lap over the sills. The attachment of second and attic floor joists was not observed.

Walls are framed with studs that are 3" by 3- 1/2" to 4". Posts are 4" by 6". The dimension of wall plates and the exact nature of the wall framing system could not be observed. Rafters for the porch roof are 2- 1/2" to 3" by 7- 3/4" by 8" and 24" between centers, with exposed ogee- scroll ends. Rafters in the main roof are 2- /12" to 3" by 9- 1/2" to 10" set on 24" centers, with every third pair doubled. Rafters are nailed together at the ridge without a ridge board.

Exterior walls are sheathed with tongue- and- groove boards, 1" by 7- 1/4", laid horizontally. Rafters are decked with a similar material. The boat room floor has sub- flooring that is also tongue- and- groove, but is twice as thick, measuring 2" by



FIGURE 64. View of typical stud wall in Room 106. (T. Jones, NPS, 2005)

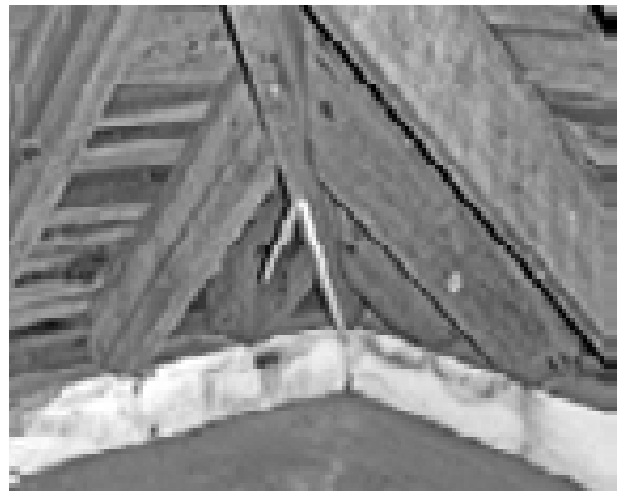

FIGURE 65. View of roof hip and junction of rafters and top plate of second floor walls. (T. Jones, NPS, 2005)



FIGURE 66. View at ridge of main roof. (T. Jones, NPS, 2005)

Physical Description



FIGURE 67. View of typical cornice. (T. Jones, NPS, 2005)



FIGURE 68. View of typical plinth at exterior walls. (T. Jones, NPS, 2005)



FIGURE 69. View of lookout and large dormer on northeast side of building. (T. Jones, NPS, 2005)

5- 1/2". It is not clear if similar sub- flooring continues in the remainder of the station.

Condition: Framing material is in generally good condition, but there are isolated areas of termite damage, including some in the rafters of the main roof. The sills along the northeast end of the building and on the northwest side in the vicinity of the boat room doors have deteriorated, and at least part of them will need to be replaced. In addition, during Hurricane Isabel in 2003, water rose as high as 22" inside the station, doing significant damage around the north corner of the Boat Room. Several floor joists were lifted completely away from the sills, buckling and dislodging much of the interior flooring in the process. Some of the joists are now missing, apparently washed away in a nor'easter that struck Portsmouth in the spring of 2005. The storms also destroyed the wall beneath window W- 6, and the area is now covered with plywood.

Exterior Finishes

The building's roof and exterior walls are clad entirely with cedar shingles that are, of course, the defining characteristic of Shingle- Style architecture. None are original, having been installed when the building was rehabilitated in the 1980s. A narrow cornice, less than a foot wide, completes the walls, except on the porches. The cornice is composed of a plain frieze board and soffit, with 3" cyma recta bed molding and a fascia with a broad quarter- round inset at its lower edge. The cyma recta bed molding and quarter round continue as a rake molding in the gable at the southwest end of the building.

The porches have unboxed eaves, and a 3" bed mold finishes the top of the walls between the exposed rafters. Six pieces of the bed molding are missing between the rafters on the southwest side of the building. The walls were originally finished at the base with a wooden plinth, 4- 1/2" wide with a beveled top edge, but much of this has been replaced with plain boards, with the original surviving only on the front porch and on part of the northwest side of the building.

Condition: Overall the exterior of the building is in good condition, although there are a number of problems with window and doors that will be discussed below. The recent storms knocked shingles

from the north corner of the watch tower, and there was significant damage to the wall finishes at the northeast end of the building, particularly under the window openings (W- 6 and W- 7).

In addition, woodpeckers or other birds have opened holes on both the northwest and southeast sides of the building where the hips of the porch roof meet the building's walls. On the southeast side, birds are entering the building through the hole and nesting in the wall cavity behind or above one the closets on that side of Room 201.

Porch

An open porch, eight feet deep under a hipped roof wraps the southwest end of the building. The floor framing is within inches of the ground with joists set on beams resting at grade. The floor is decked with tongue- and- groove flooring, 7/8" by 2- 1/2", all modern material. A 1" by 6" board skirts the porch, and modern shiplap siding replaces the lattice that was originally used to close off the area beneath the porch. Rafters are supported by a 4" by 6" header set on posts that are 5- 1/2" by 5- 1/2" by 8' tall. Posts have chamfered edges and are set on plinths 1- 1/2" thick with beveled edges. There is no evidence that a balustrade or railing was ever present.

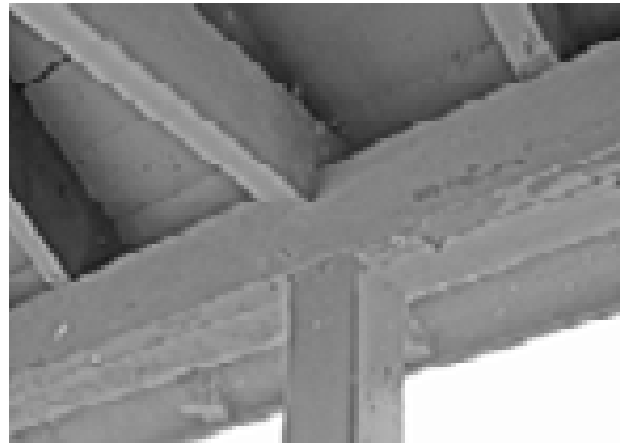

FIGURE 71. View of typical header and post on porch. (T. Jones, NPS, 2005)



FIGURE 72. View of junction of porch rafters and walls. (T. Jones, NPS, 2005)



FIGURE 70. View porch wrapping northwest end of building. (T. Jones, NPS, 2005)

Physical Description

FIGURE 73. Plan showing numbering of windows and doors. (T. Jones, NPS, 2005)

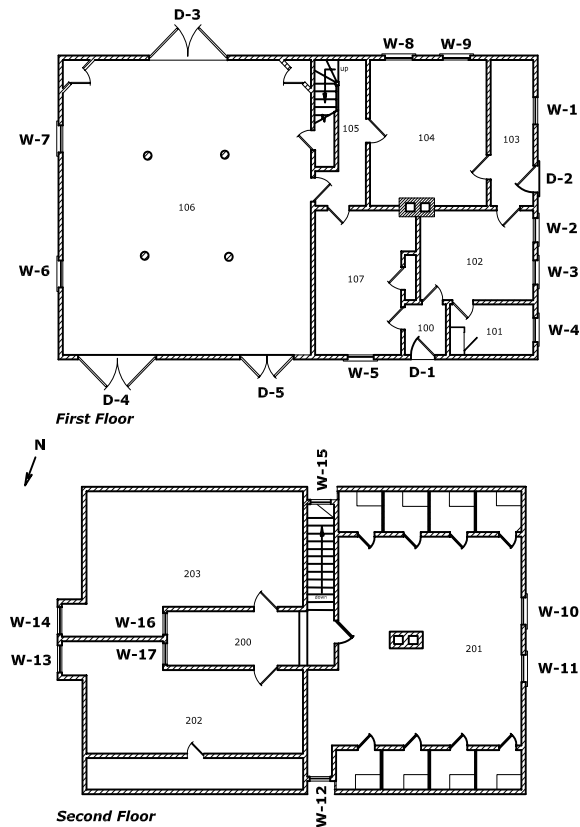

W-1	3'-4" by 2'-9", single sash, nine lights, originally top hinged
W-2	2'-10" by 5'-8", nine over two, double hung, one light broken
W-3	2'-10" by 5'-8", nine over two, double hung, one light broken
W-4	2'-10" by 5'-8", nine over two, double hung, two lights broken
W-5	3'-4" by 5'-10", nine over two, double hung
W-6	3'-4" by 5'-10", nine over two, double hung, sash and frame out of opening
W-7	3'-4" by 5'-10", nine over two, double hung
W-8	3'-4" by 5'-8", nine over two, double hung, ropes broken
W-9	3'-4" by 5'-8", nine over two, double hung, ropes broken
W-10	3'-0" by 4'-4", six over two, double hung
W-11	3'-0" by 4'-4", six over two, double hung
W-12	2'-10" by 4'-4", six over two, double hung
W-13	3'-0" by 4'-4", six over two, double hung, ropes broken
W-14	3'-0" by 4'-4", six over two, double hung, ropes broken
W-15	2'-10" by 4'-4", six over two, double hung
W-16	2'-6" by 2'-7", single sash, four light, top hinged, all glass missing
W-17	2'-6" by 2'-7", single sash, four light, top hinged, all glass missing
attic	2'-4" by 3'-5", two over two, double hung
tower	seven openings, 1'-8" by 2'-4", single sash, three lights, top hinged

Condition: Most features of the porch, including the flooring, are in good condition. The bottoms of some of the columns are deteriorating, but none of the damage necessitates column replacement. Some quarter-round that finishes the header on the southwest side of the building is missing, and several runs of the bed molding between the rafters at the walls of on the northwest side of the house are also missing.

Windows

The building has twenty- three windows, fifteen of which have double- hung, counterweighted sash. Double- hung windows are nine- over- two on the first floor, six- over- two on the second floor, and two- over- two in the attic. There is a single, nine- light, top- hinged sash at the window into Room 103 (W- 1), and the seven windows in the tower each have a single, top- hinged, three- light sash. Window casing is around 3- 1/2" wide and 1- 1/8" thick and includes a deeply molded, 2- 3/8"- wide, backband around the perimeter of the tops and sides of the cased opening. Window sills are 2- 1/4" thick.

Windows into living areas of the building (W- W- 2, W- 3, W- 5, W- 8, W- 9, W- 10, W- 11, W- 12, W- 13, W- 14, W- 15) were probably all originally fitted with wood- framed screens, but only the brackets from which they hung remain in place. Some of the

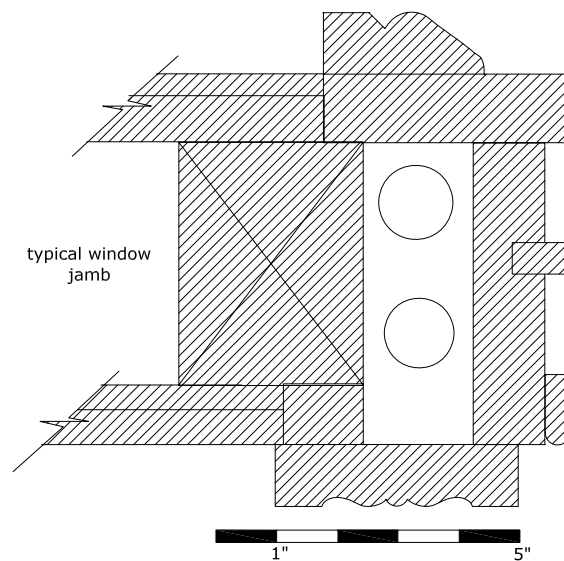

FIGURE 74. Section through exterior wall at window jamb. (T. Jones, NPS, 2005)

screens may be among those that remain in storage in the attic, including at least five whose measurements appear to match those of the tower windows. All of the windows were probably also originally fitted with solid, board- and- batten storm shutters, which were probably hung in a manner similar to the screens. Five small board- and- batten shutters remain in storage in the attic and probably fit the tower windows, although it is unclear how they would have been hung.

The building has three gabled dormer windows, located on the northwest, northeast, and southeast sheds of the roof. The northwest and southeast dormers both have a single double- hung window, shingled walls and cyma recta cornice and gable rake molding. The northeast dormer is finished in a similar fashion but is larger and has double windows.

Condition: Some of the sash may have been replaced, and most are in good condition, although many of the counterweight ropes are broken and there are several panes of broken glass. The sash in the attic window, which are almost certainly original, are badly weathered, primarily because the interior side of the sash has not been maintained. At the northeast end of the boat room (Room 107), recent storms badly damaged both windows (w- 6 &



FIGURE 75. View of typical window casing. (T. Jones, NPS, 2005)



FIGURE 76. View of W-2, a typical nine-over-two window. (T. Jones, NPS, 2005)



FIGURE 77. View of southeast dormer. (T. Jones, NPS, 2005)



FIGURE 78. Door D-1 on northwest side of house. (T. Jones, NPS, 2005)



FIGURE 79. Door D-2 on southwest side of house. (T. Jones, NPS, 2005)

W- 7), knocking the sash and frame completely from one opening (W- 6). Both windows are now covered with plywood, as are the two windows (W- 13 and W- 14) in the double dormer, which may also have been damaged in the recent storms.

Doors

The building has five exterior door openings, all of them historic. On the northwest and southwest sides of the building, there are entrance doors that provide access to the building's living quarters. In addition, there are large, double, board- and- batten doors at the entrances into the boat room (Room 107), with two of them on the northwest side and one on the southeast side.

Entrance Doors

The two entrance doors (D- 1 and D- 2) appear to be original features of the station. Although they differ slightly, both are just under seven feet tall and each is surmounted by an 18"- high, three- light transom. Door D- 1 on the northwest side of the building opens into Room 100 and is 2'- 10" by 6'- 10" by 1- 3/ 4" with four vertical panels and a fifth, horizontal panel between the upper and lower pairs of panels. Door D- 2 on the southwest side of the building opens into Room 103 and is 3'- 0" by 6'- 10" by 1- 3/ 4". Its panel molding is similar to that of the other exterior door, but there are only four vertical panels, without the fifth, horizontal panel found on Door D- 1. Both doors are hung with three, 4" by 4" butt hinges with removable, ball- tip pins. Casing for the



FIGURE 80. View of Door D-5. (T. Jones, NPS, 2005)

entrance doors is like that used for the windows, but with the addition of a 1- 1/4”- thick drip cap at the top.

Condition: Although the doors themselves are in reasonably good condition, historic mortise locks are inoperative or missing. The historic lock set and escutcheon plates are entirely missing from the northwest door but remain on the southwest door, although the lock is missing its thumb latch so that it is essentially inoperative. An historic deadbolt lock is also missing from both doors, and one hinge is missing from door D- 1. The sill to the southwest door has been replaced, but its installation damaged the door frame and the sill itself appears not to be attached to the building’s framing.

Boat Room Doors

There are three double doors opening from the Boat Room. Door D- 3, on the southeast side of the building, and Door D- 4, on the northwest side of the building, are around 9’- 6” wide and 9’- 5” high. The third door, D- 5, also on the northwest side of the building is smaller, measuring around 6’- 6” wide by 8’- 6” high. All three doors appear to have been constructed in a similar fashion, but the modern plywood covering the exterior of the doors makes characterization of the doors’ construction uncertain. Stiles and rails are 2- 3/8” thick and 6- 1/2” wide. Tongue- and- groove boards, 3/4” by 2- 1/2”, are set vertically into grooves in the stiles and rails



FIGURE 83. View of historic handle and escutcheon on door D-2. (T. Jones, NPS, 2005)



FIGURE 82. View of one leaf of Boat Room door D-3. The diagonal brace is not an historic feature. (T. Jones, NPS, 2005)



FIGURE 81. View of typical upper (left) and lower (right) sliding bolts on boat room doors. (T. Jones, NPS, 2005)

Physical Description



FIGURE 84. View of damage to lower panel of leaf of Boat Room door D-5. (T. Jones, NPS, 2005)

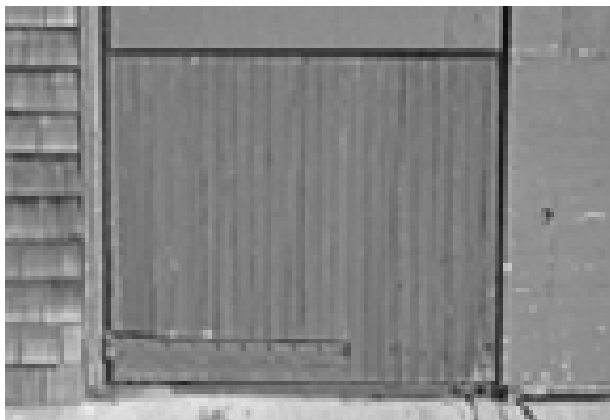

FIGURE 85. View of one leaf of double doors at D-3, showing typical original hinge and added layers of tongue-and-groove material and plywood. (T. Jones, NPS, 2005)



FIGURE 86. View of typical drip cap at Boat Room doors. (T. Jones, NPS, 2005)

and appear to be overlaid with 7/8" by 3" beaded tongue- and- groove boards set diagonally into the same grooves in the stiles and rails. In addition, another layer of vertical tongue- and- groove boards (historic but not original) is visible on the exterior of Door D- 4 and is probably present on the other doors as well. All three sets of doors are covered on the exterior with modern 1/2" plywood installed on top of the historic tongue- and- groove material.

The doors are hung with large strap hinges bolted to the exterior surface of the doors. All but one of the hinges is covered b y modern plywood, but hinges for the large doors appear to be about 36" long, while those for the smaller doors are somewhat shorter. Originally, the doors were secured when closed using large zinc or galvanized steel sliding bolts mounted to the interior surface of the doors. Each door is equipped with two sliding bolts, one fastening the top of the door and the other the bot- tom. In addition, there was originally a metal pull on the interior of each door. All of this hardware appears to have been part of the building's original construction.

Casing for the boat room doors is similar to that used for the windows and entrance doors, although the alterations to the boat room doors has reduced the apparent projection of the back band. The backband found at the top of the windows and entrance doors is replaced at the boat room doors by plain boards, 1- 1/4" thick, supported by small scrolled brackets at each end and projecting as much as 3" beyond the plane of the walls. The pro- nounced cant of these boards allows them to func- tion as a drip cap that helps protect the tops of the doors from rainwater.

Condition: All three sets of boat room doors are deteriorated, and crossbraces have been added to strengthen the large doors. Deterioration is espe- cially pronounced along the doors' lower edges, but Door D- 4 was also severely damaged in the recent storms, with some of the paneling in the lower part of the door torn away. The historic hardware remains completely intact on only two of the six boat room doors. On the others, the lower bar guide is missing or broken and the interior pull is missing from two of those. Some or all of the drip caps appear to have been replaced, perhaps with some- what narrower material.

Interior

The original floor plan of the station house remains intact with no alterations, although there have been a number of alterations to interior finishes. The first story contains slightly more than 2,000 square feet of floor space, over half of that encompassed by the boat room (Room 107) at the northeast end of the building. The remainder of the first floor is occupied by an entrance hall (Room 100), a pantry (Room 101) that was later converted to a bathroom, an indoor kitchen (Room 102) later used as an office, another entrance hall (Room 103) that was known as the “Storm Clothes Room” and part of which was also later converted into a bathroom, a “Mess Room” (Room 104) for the crew, a stair hall (Room 105) with stairs to the second floor, and the keeper’s room (Room 106).

The second story contains only about 1,800 square feet, with a significant portion of that around the perimeter of the floor not useful except for storage

due to low heights under sloping ceilings. Stairs rise from the first floor into an L-shaped stair hall (Room 200) that provides access to the other rooms on the floor and includes ladder access to the attic and the lookout tower. The largest room, located at the southwest end of the floor, is the crew’s quarters (Room 201), which is flanked on both the northwest and southeast sides by a series of four walk-in closets. At the northeast end of the floor, above the boat room, are a large store room (Room 203) and a spare room (Room 202).

A ladder in the second floor hall (Room 200) accesses an intermediate landing from which another ladder rises to the lookout tower. A door opening from the intermediate landing provides access to an attic above the second floor.

Flooring. Most if not all of the flooring is assumed to be original. All of it is painted, tongue- and-groove, probably quarter-sawn pine, but in a mixture of 2- 1/2” and 3” wide material. Flooring in

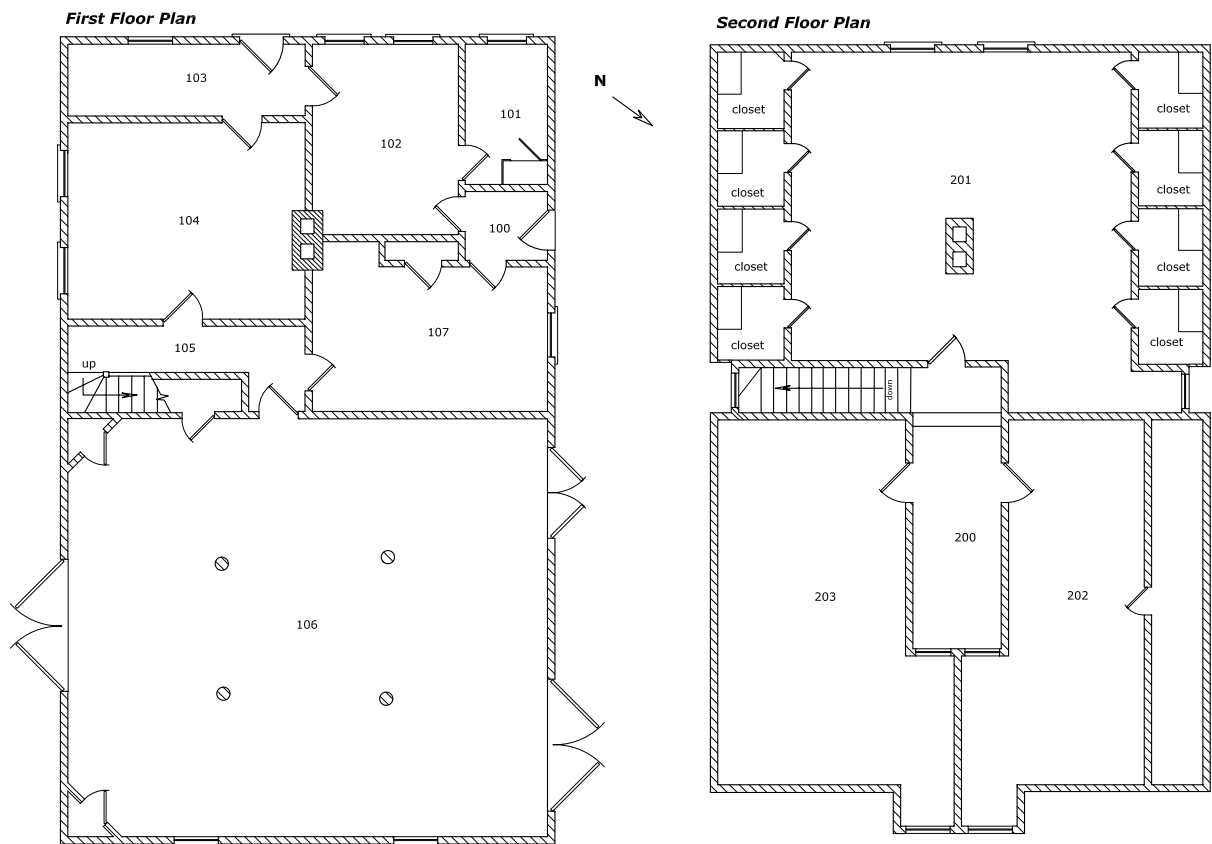

FIGURE 87. Floor plans of existing building. Scaled drawings may be found at the end of this section.

Physical Description



FIGURE 88. View of original plaster on wood lath in one of the closets in Room 201. (T. Jones, NPS, 2005)

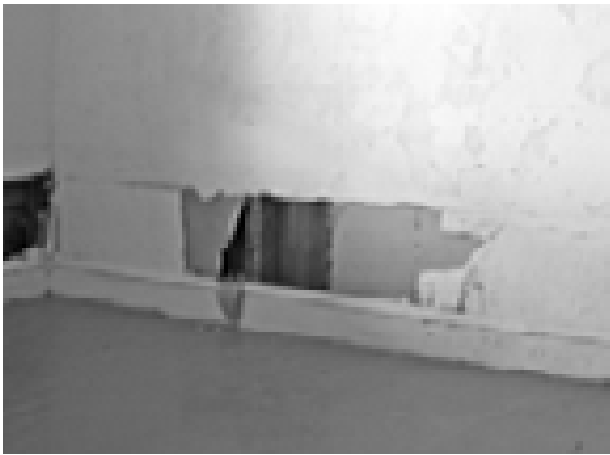

FIGURE 89. View of water-damaged plaster on rock lath in Room 106. (T. Jones, NPS, 2005)



FIGURE 90. View of typical flooring, wainscot, and baseboard. (T. Jones, NPS, 2005)

Rooms 100, 102, and 202 is all 3"- wide material and that in Room 104 is all 2- 1/2" wide material. Flooring in the other rooms is a mixture of widths, sometimes alternating with every other board a different width. Presumably, the mixture of widths was the result of an initial mistake in ordering material, since the differences do not appear to be attributable to later repairs. A 3"- wide saddle is present at each interior door opening.

Condition: Flooring is in good condition on the second floor, but the recent storms and accompanying flooding tore loose a large section of the flooring in Room 107 and buckled a section of the flooring in Room 104. The remainder of the flooring on the first floor is in fair condition, with only slight cupping of the boards as a result of the flooding. Flooring on the second floor remains in good condition.

Walls and Ceilings. Ceilings are generally set about 9'- 6" above the floor, and most of the wall and ceiling finishes are historic if not actually original to the building. Nearly all of the original plaster on wood lath was replaced with plaster on a plaster-board substrate, probably during World War II. Original plaster on wood lath remains intact only in the closets. Original wainscoting, ranging in height from 37" to 43", is present in Rooms 100, 103, 104, 105, and 107 and is composed of 3"- wide, single-beaded, tongue- and- groove boards installed vertically. A 2- 1/4" molded chair rail finishes the wainscoting, except in Room 107 where a 4" chair rail is present. Walls and ceiling in Room 107 are finished with 3", single-beaded, tongue- and- groove boards, which is assumed to be original material. The material is installed vertically below the chair rail and horizontally above. Walls and ceilings in Rooms 101 and 102 are finished with 2- 1/2"- wide, V- joint, tongue- and- groove boards, installed vertically on the walls. This material probably dates to the early twentieth century. It is likely that the original walls and ceilings in Rooms 101 and 102 were plastered, but that is not certain.

Condition: The lower two or so feet of the plaster walls on the first floor have been severely damaged by the recent flooding, when water rose as high as 22" inside the station. Above the water line, the upper walls and ceilings are in fair condition and can be easily repaired. In the closets, where the original plaster on wood lath was not replaced, much of the plaster is missing, although the wood

lath remains intact. All of the tongue- and- groove wall and ceiling finishes remains in excellent condition.

Wood Trim. Doors and windows are trimmed with a 4" molded casing and "bull's-eye" corner blocks. Door casing terminates in a plain, 8", base block or plinth. In Rooms 101 and 102, the casing terminates at the chair rail, which also forms a stool and apron for the window opening. Where a wainscot is not present, a conventional stool and apron are used. Baseboards are of three basic types. In Rooms 103, 104, and 105), there is a 6" baseboard without a base cap but with a slightly rounded upper edge. These baseboards do not butt to the base blocks in a conventional manner but rather lap over the block and terminate at the edge of the door opening. In Room 106 and in all the rooms on the second floor, there is a plain 5" baseboard with a 1- 1/2" ogee base cap. The same type of baseboard is used in Rooms 101 and 102, but there the board is 5'- 3/4" plus a 1- 1/2" double- ogee base cap. The baseboard in Room 107 is unique, consisting of a single board, 7/8" by 3- 1/2" with a V- shaped groove down the center of the board. It is not clear if shoe molding was ever present with any of the baseboards.

Doors. Interior doors have six raised panels, except for the closet doors on the second floor where two-panel and one single- panel doors are present. The doors between Rooms 100 and 101, 101 and 102, and both doors from Room 106 are 2'- 6" wide; the remainder of the principal doors are 2'- 10" wide. Closet doors in Room 107 are 2'- 4" wide and the second floor closet doors are 2'- 0" wide. Most doors are 6'- 10" tall, with a single 6'- 8" door between Rooms 101 and 102, a 7'- 0" door between Rooms 105 and 107, and closet doors at 6'- 0". Doors are hung with a pair of 4", brass, loose- pin, butt hinges.

The design of the original locks on the principal doors inside the building is not known, since all were replaced in 1913 with the present mortise locks, which feature simple oval door knobs and escutcheons with a beaded edge in a design first introduced in the 1890s. A number of the knobs and escutcheons are now missing. The lock in the door between Rooms 101 and 102, which is typical of the mortise locks elsewhere in the building is imprinted "Wrought Steel/Pat'd Sept 1, 1891/Yale & Towne Mfg. Co./Stamford, Conn. USA."



FIGURE 91. Typical six-panel door and casing. (T. Jones, NPS, 2005)



FIGURE 92. Typical door knob and escutcheon. (T. Jones, NPS, 2005)



FIGURE 93. View north from Room 102 into Room 100. (T. Jones, NPS, 2005)



FIGURE 94. View northeast in Room 101. (T. Jones, NPS, 2005)

Room 100 (Hall)

Measuring about 4'-11" by 5'-11" with a ceiling at 9'-1/2', this small space functions as an entrance hall from the porch on the northwest side of the building and provides access to the keeper's room (Room 106) and the kitchen (Room 101). Except for the plaster walls and ceiling, all of the finishes in this room are original.

Flooring: Flooring is 3"-wide, painted, tongue- and-groove pine, presumably original to the space. Flooding has caused slight cupping of the floor boards.

Walls: Walls are finished with plaster on plaster-board above a wooden wainscot that rises to about 37" above the floor. The wainscot is composed of 3"-wide, beaded, tongue- and-groove boards and is completed with a 2"-wide molded chair rail.

Ceiling: The ceiling is plaster on plaster board in good condition. A water line runs across the ceiling above the entrance door to service a sink that once existed in Room 107.

Doors: In addition to the exterior entrance door discussed above, two six-panel doors open from this room, one into Room 102 and one into Room 106. Both are 2'-6" by 6'-10" by 1-3/4", and all original hardware is present.

Wood Trim: Doors are cased with typical 4" casing, bull's-eye corner blocks, and 8" base block. There is a typical 6" baseboard and a 2" molded chair rail typical of the original construction.

Room 101 (Pantry/Bathroom)

Entered from the building's original kitchen (Room 102), this space is around 5'-11" by 11'-9". Designed as a pantry for the kitchen, it appears to have been remodeled for a bathroom and/or storage after the kitchen was relocated to a separate building. Most of the original finishes, except flooring, appear to have been replaced at that time. A wooden cabinet in the north corner of the room was installed during World War I as a gun locker, and it may have been shortly after that time that the room was converted into a half bathroom. The NPS installed a shower in the west corner of the room when the building was used as a residence in the 1980s.

Flooring: Flooring is a random mixture of 3"- wide and 2- 1/2"- wide material. The flooring is painted except where the toilet and shower were located, indicating that the flooring was painted after the those features were installed.

Walls: Walls are finished with vertically installed, V-joint, tongue- and- groove boards, 2- 1/2" wide. Originally stained and varnished, the walls are now painted.

Ceiling: The ceiling is finished with the same 2- 1/2"- wide, V- joint, tongue- and- groove boards as the walls.

Door: The single door, opening from Room 102, is a typical six- panel door, but at 2'- 6" by 6'- 8" by 1- 1/2". Except for closet doors, it is both shorter and thinner than the typical interior door. All hardware is present, including knobs. The mortise lock is stamped on the interior with "Wrought Steel/Pat'd Sept 1, 1891/Yale & Towne Mfg Co/Stamford, Conn., USA."

Window: Located on the northwest wall, the single window in the room is a typical double- hung window, nine over two, 2'- 10" by 5'- 8". Both panes of glass in the lower sash are broken.

Wood Trim: The door and window are cased with typical 4" casing with bull's- eye corner blocks. The room is finished with a 5- 3/4" baseboard with a 1- 1/2" molded base cap and with a plain 4- 1/2" two- part chair rail set at about 45" above the floor. The same molding used as a base cap is inverted and used as a crown molding at the junction of the walls and ceiling.

Miscellaneous: In the north corner of the room, a small closet was added during World War I. Measuring 1'- 9" by 3'- 3" by 7'- 0", it was constructed with V- joint tongue- and- groove material similar to that which was used for the walls and ceilings. The interior of the closet has a series of shelves and a separate section that is designed as a rack to hold a nine rifles.

Room 102 (Kitchen/Office)

With entry from either Room 100 or Room 103, this room measures 10'- 5" by 13'- 8". The room was the station's original kitchen before construction of the so- called "summer kitchen" in the early twentieth



FIGURE 95. View west in Room 101. (T. Jones, NPS, 2005)



FIGURE 96. View northeast of gun cabinet in Room 101. (T. Jones, NPS, 2005)

Physical Description



FIGURE 97. View east in Room 102. (T. Jones, NPS, 2005)

century. After that, the room was apparently remodeled with new wall and ceiling finishes.

Flooring: Flooring is painted, but unlike some rooms, where a mixture of flooring widths was used, flooring here the flooring is all 3"- wide tongue- and- groove.

Walls: Walls are finished with typical 2- 1/2"- wide, V- joint, tongue- and- groove boards, probably installed in the early twentieth century.

Ceiling: The ceiling is finished with 2- 1/2'- wide, V- joint, tongue- and- groove boards, probably installed in the early twentieth century.

Doors: In addition to the door opening from the hall (Room 101) and into the pantry (Room 102), a third six- panel door opens from the storm- clothes Room (Room 103). It measures 2'- 10" by 6'- 10" by 1- 3/4". Its original hinges, mortise lock, and escutcheons remain intact, but the knobs are missing.

Windows: The room has two windows on the northwest wall. Both are double- hung, nine- over-



FIGURE 98. View west in Room 102. (T. Jones, NPS, 2005)

two, and are 2'- 10" by 5'- 8". One of the large panes in each of the lower sash is broken.

Wood Trim: The room features a two- part base-board and two- part chair rail about 37" from the floor, both features like those found in Room 101. In addition, there is a 4" crown molding at the junction of the walls and ceiling. Windows and doors have a typical 4" molded casing with bull's- eye corner blocks.

Miscellaneous: A corner of the chimney projects into the east corner of the room. About seven feet from the floor is a stove- pipe flue for the cook stove that would have been in place when the room was used as a kitchen.

Room 103 (Storm Clothes Room)

With a door to the outside, this room also provides access to the original kitchen (Room 102) and to the mess room (Room 104). The room measures 5'- 1" by 16'- 11" but, during World War I, was subdivided by a light curtain wall to create a wash room for the surfmen. The fixtures for that bathroom have since been removed, and the space is now used for storage.



FIGURE 100. View north in Room 102. (T. Jones, NPS, 2005)



FIGURE 99. View south in Room 102. (T. Jones, NPS, 2005)



FIGURE 101. View southwest in Room 103. (T. Jones, NPS, 2005)

Physical Description



FIGURE 102. View southwest in Room 103. (T. Jones, NPS, 2005)



FIGURE 103. View of marks showing high-water marks for recent hurricanes. (T. Jones, NPS, 2005)

Flooring: Flooring is painted, 3”- wide, tongue- and- groove, slightly cupped as a result of flooding.

Walls: An original wainscot consists of 3”- wide, beaded, tongue- and- groove boards, installed vertically to a height of 43”, which includes a chair rail like that found in Room 100. The remainder of the walls are finished with typical plaster on plaster board replacing the original plaster on wood lath. The wall that was added to partition the space for a bathroom is set about 7’- 2” from the northeast end of the room and rises to a height of about 7’- 3”. The wall is constructed of 2- 1/2”- wide, V- joint tongue- and- groove boards installed vertically and matching the boards used on the walls and ceiling in Rooms 101 and 102.

Ceiling: The ceiling is typical plaster on plaster board replacing the original plaster on wood lath.

Doors: In addition to the door openings from the exterior (D- 2) and into Room 102, a third door opens into Room 104. It is a typical 6- panel door, 2’- 10” by 6’- 10” by 1- 3/4” but is missing its knobs and escutcheon plates, although its original hinges and mortise lock remain intact. A fourth door was added along with the partition wall. It is 2’- 7” by 6’- 11” by 1” and has three, flat, plywood panels, a simple metal pull, and a hook- and- eye latch.

Windows The room has a single window set high on the northwest wall. It is 3’- 3” wide by 2’- 9” high and has nine lights. The sash is fixed now and although there are no visible hinges, it must have once been a top- hinged window. Hooks on each side of the interior frame appear to have facilitated holding the sash open.

Wood Trim: The three original doors are cased with typical 4” casing, bull’s- eye corner blocks, and 8” base block. The added fourth door is without casing. The window is trimmed with typical 4” casing with bull’s- eye corner blocks at upper and at lower corners. There is a typical 6” baseboard and a 2” molded chair rail typical of the original construction, both like those used in Room 100. A plain 4”- wide board beaded on both edges was installed on all four walls of the original space. Set with the top about 71” from the floor, the board has a series of coat hooks, an indication of the room’s original purpose.

Miscellaneous: On the base board and door casing adjacent to the door to Room 104, park staff have marked the high water mark for three hurricanes that struck Portsmouth in recent years. The first was for Hurricane Dennis on 30 August 1999 when water rose to about 3” inside the station, followed by Isabel on 18 September 2003 when the high water mark was at 22”. The third mark is for Alex on 3 August 2004 when there were 4” inches of water inside the station.

Room 104 (Mess Room)

Measuring 14’- 1” by 16’- 11”, this room is entered from the storm- clothes room (Room 103) or the stair hall (Room 105). Designated “mess room” in the original plans for this type life- saving station, this room also functioned as a sort of living room for the station’s crew and is the only room in the building with a fireplace.

Flooring: The entire floor is laid with painted, 2- 1/2” wide, tongue- and- groove flooring, the only floor in the building laid entirely with the narrower flooring. As a result of storm flooding, flooring is severely buckled on the northwest side of the room.

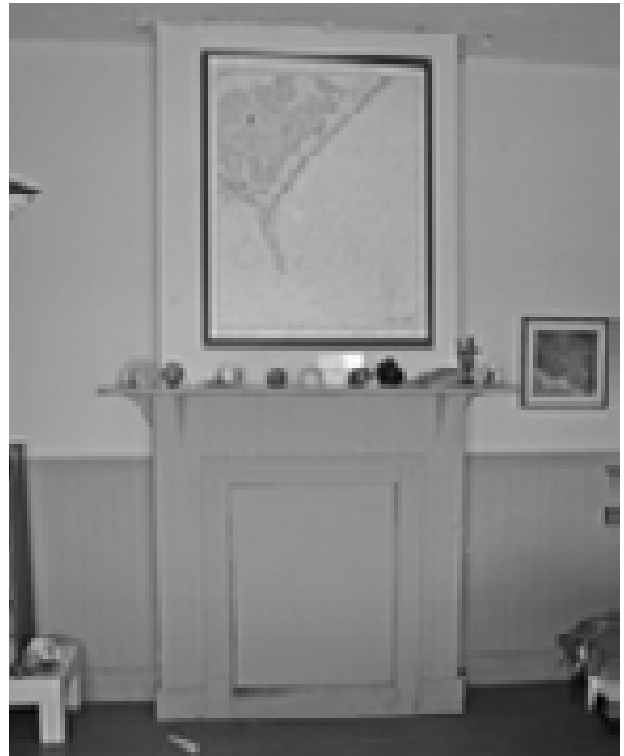

FIGURE 105. View north in Room 104. (T. Jones, NPS, 2005)



FIGURE 104. View east in Room 104. (T. Jones, NPS, 2005)

Physical Description



FIGURE 106. View of mantel shelf in Room 104. (T. Jones, NPS, 2005)



FIGURE 107. View of typical double window stool. (T. Jones, NPS, 2005)

Walls: An original wainscot, like that in Room 103, consists of 3"- wide, beaded, tongue- and- groove boards, installed vertically to a height of 43", which includes a chair rail like that found in Rooms 100 and 103. The remainder of the walls are finished with typical plaster on plaster board replacing the original plaster on wood lath.

Ceiling: The ceiling is typical plaster on plaster board replacing the original plaster on wood lath.

Doors: In addition to the door opening from Room 103, a second door opens from Room 105. It is a typical 6- panel door, 2'- 10" by 6'- 10" by 1- 3/4". Its original knobs are missing, with a glass knob replacing one of the missing originals. There is a 3- light, top- hinged transom, the hardware for which is in place but bent, rusted, and inoperative.

Windows The room has two windows on the southwest wall. Both are typical double- hung, nine- over- two, 3'- 4" by 5'- 8". Counterbalance ropes are broken on both windows.

Wood Trim: The doors are cased with typical 4" casing, bull's- eye corner blocks, and 8" base block. Windows use the same casing and bull's- eye corner

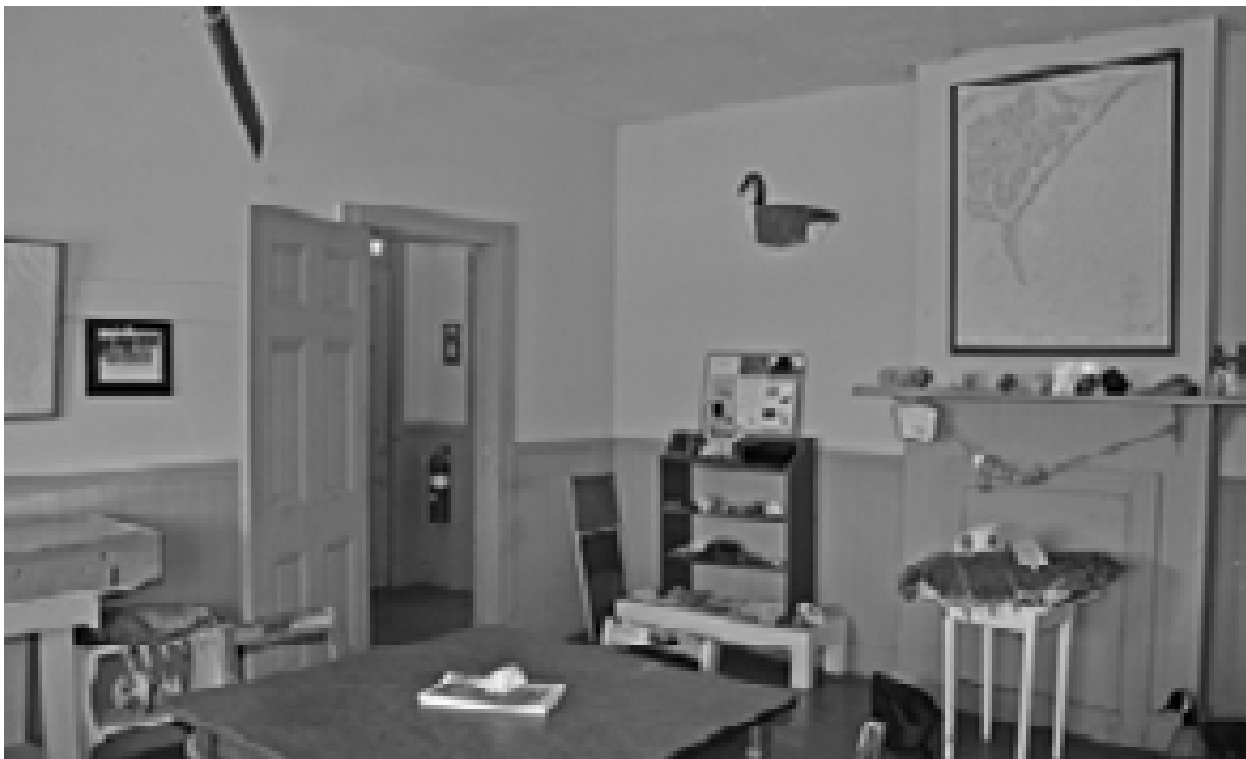

FIGURE 108. View west in Room 104. (T. Jones, NPS, 2005)

blocks as the doors. Windows have an unusual double stool, which was probably installed to inhibit water infiltration from wind-driven rain. In addition, unlike the windows in Rooms 102 and 107, the window casing does not terminate at the chair rail, but rather descends to base blocks at the floor. This suggests that the windows might have once been door openings, but there is no other evidence for that. Since two windows at this location were part of the original plan for this type station, it is likely that this treatment of window trim was simply to give the room a more formal appearance, although analysis of painted finishes would be necessary to confirm that assumption. A typical 6" baseboard like that in Rooms 100 and 103 surrounds the room. A 7/8" by 5-3/4" board with a series of coat hooks is mounted on the southwest wall at a height of 71", running between the door to Room 103 and the south corner of the room.

Fireplace: This room has the only fireplace in the station, although it is not clear if it was actually built for an open, coal-burning fire or just for a coal- or wood-burning stove. Typical 4" molded casing, bull's-eye corner blocks, and 8" base blocks frame what appears to be a firebox opening, which is now closed, and the remainder of the fireplace surround



FIGURE 110. View of door in Room 104. (T. Jones, NPS, 2005)



FIGURE 109. View south in Room 104. (T. Jones, NPS, 2005)

Physical Description



FIGURE 111. View northeast in Room 105. (T. Jones, NPS, 2005)

is finished with 3" beaded tongue- and- groove boards like those used for the wainscoting. The wooden fireplace surround and the apparent lack of a hearth suggests that the fireplace was constructed for a wood- burning stove and not for an open fire. A wooden mantel shelf is mounted on four cast-iron brackets at a height of about 58".

A small wooden shelf measuring about 1' by 2' is mounted on the northeast wall at the north corner of the room. Its original purpose is not known but it may have served as a telephone stand. On the southwest wall on the east side of the windows is a small wooden panel a few inches above the floor. Its original purpose is also unknown.

Room 105 (Stair Hall)

Providing access to the second floor, this room can be entered from Rooms 104, 106, or 107. The room is around 6'- 2" by 16'- 10".

Flooring: Flooring is a random mix of 2- 1/2"- and 3"- wide, painted, tongue- and- groove pine, presumably original to the space. Flooding has caused slight cupping of the floor boards.



FIGURE 112. View north in Room 104. (T. Jones, NPS, 2005)

Walls: As in Room 100, walls are finished with plaster on plasterboard above a wooden wainscot that rises to about 37" above the floor. The wainscot is composed of 3"- wide, beaded, tongue- and- groove boards and is completed with a 2"- wide molded chair rail.

Ceiling: The ceiling is plaster on plaster board in good condition.

Doors: In addition to the door opening into Room 104, a similar six- panel door, 2'- 6" by 6'- 10" by 1- 3/4" opens into Room 106. A third door, 2'- 10" by 7'- 0" by 1- 3/4" opens from Room 107. It, too, is a typical six- panel door, and all original hardware is present on both doors. In addition, a wood- framed screened door, presumably historic, is present at the door to Room 106.

Wood Trim: Doors are cased with typical 4" casing, bull'- eye corner blocks, and 8" base block. There is a typical 6" baseboard and a 2" molded chair rail like those in Rooms 100, 103, and 104.



FIGURE 114. View northwest of stairs to second floor. (T. Jones, NPS, 2005)



FIGURE 113. View southwest in Room 105. (T. Jones, NPS, 2005)



FIGURE 115. View of newel post and bannisters. (T. Jones, NPS, 2005)

Physical Description



FIGURE 116. View northwest in Room 106. (T. Jones, NPS, 2005)

Staircase: The open stairs to the second floor have an open stringer and have treads with a rise of 8" and a run of around 11-1/4". One-inch cove molding rims the treads to the stringer casing. The newel post is 4" by 4" by 43" and has an ovoid post cap molded with concentric rings. The molded hand railing is 2" thick, and there are two 1"-diameter pickets at each step.

Room 106 (Keeper's Room)

Entered from either of the two hallways on the first floor, this room was designed to be the Keeper's personal room. It measures 16'-10" by 10'-4" and is the only room on the first floor without a wainscot.

Flooring: Flooring, which is painted, consists of alternating 3"-wide and 2-1/2"-wide boards. Flooding has caused some cupping of the material.

Walls and Ceilings: Walls and ceiling are finished with plaster on plaster board. Recent flooding badly damaged the lower portions of the walls, and some of the plaster board has been removed. Residue from the original plaster on wood-lath walls is visible on exposed studs.



FIGURE 117. View west in Room 106. (T. Jones, NPS, 2005)

Doors: The room has two typical six- panel doors into the room, one opening from the entrance hall (Room 100) and one from the stair hall (Room 105). Both are 2'- 6" by 6'- 10" with all hardware intact, although the knob on the door to Room 100 is damaged. In addition, there is a single closet door, which also has six panels and is 2'- 6" by 6'- 10" by 1- 3/4", but it is missing knobs and escutcheons.

Window: There is one window in the room, located on the northwest wall. It is a typical double- hung, nine- over- two, 3'- 4" by 5'- 8".

Woodwork: The window and doors are trimmed with typical 4"- wide molded casing with bull's- eye corner blocks, and the doors have a typical 8" base block or plinth. Unlike the rooms with wainscoting, this room has a 5" baseboard with a 1- 1/2" ogee base cap.

Miscellaneous: This room has a single closet, complete with three shelves. On the southeast side of the closet, there is an alcove that now has two shelves. The chimney breast protrudes into the south corner of the room, and a flue for a heating stove was originally located in the alcove. The L- shaped mantle



FIGURE 119. View of closet in Room 106. (T. Jones, NPS, 2005)



FIGURE 118. View south in Room 106. (T. Jones, NPS, 2005)

Physical Description



FIGURE 120. View of closets on southwest side of Room 107. (T. Jones, NPS, 2005)



FIGURE 121. View of flooring damaged by storm surge in 1993. (T. Jones, NPS, 2005)

depicted on the earliest plans of the building have been replaced by two shelves that are probably contemporaneous with the plaster board walls and ceiling.

Room 107 (Boat Room)

Occupying the eastern half of the building's first floor, the Boat Room was used for the storage and maintenance of the life-saving station's smaller boats. Entered from the residential portion of the building through a door from Room 106, the room also has three, large, double doors opening to the exterior, two on the northeast wall and one on the southwest wall. The room measures approximately 34'-1" from northwest to southeast and around 30'-1" from northeast to southwest. It includes Closet A located under the staircase in Room 106 as well as Closets B and C which are triangular closets in the south and east corners of the room.

Flooring: Flooring is a typical mixture of 2- 1/2" and 3"- wide tongue- and- groove flooring. The storm surge that accompanied Hurricane Isabel in 1993 did severe damage to the north corner of the room, including dislodging sub- flooring and flooring from the floor joists, although the flooring itself was not destroyed.



FIGURE 122. View southeast in Room 107. (T. Jones, NPS, 2005)

Walls: Walls are finished with the 7/8" by 3" beaded tongue- and- groove boards typical of the original station. Below a chair rail installed about 41" above the floor the boards are installed vertically; above the chair rail, the boards are installed horizontally. All of the wall boards are painted and most are in very good condition.

Ceiling: At 11'- 1", the ceiling here is significantly higher than the 9'- 6" typical in the remainder of the station. It is finished with typical 3" beaded tongue- and- groove boards. Two wooden headers, about 6' by 9", divide the ceiling into thirds. Each header is supported across its span by a pair of 7- 1/2" diameter columns with elongated capitals with ogee ends. Near the center of the northwest side of the ceiling is a 35- 1/2" by 56- 1/2" hatch opening to the second floor hall, which allowed large items to be hoisted to the second floor without resort to negotiating the relatively narrow stairs.

Doors: In addition to the three exterior doors and the door into Room 105 described above, there are three closet doors. All are six- panel doors, with the two corner- closet doors measuring 2'- 4" by 6'- 0" and the other closet door measuring 2'- 4" by 6'- 8". Hardware is intact on all three doors.

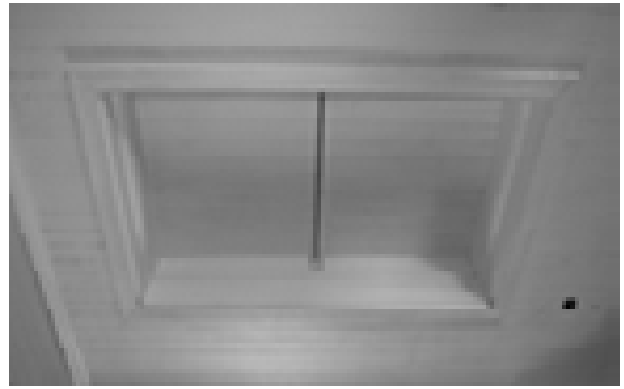

FIGURE 124. View of ceiling hatch to second floor. (T. Jones, NPS, 2005)



FIGURE 125. View of header and top of post in Room 107. (T. Jones, NPS, 2005)



FIGURE 123. View west in Room 107. (T. Jones, NPS, 2005)

Physical Description



FIGURE 126. View of corner closet in Room 107. (T. Jones, NPS, 2005)

Windows: The room has two windows, both located on the room's northeast wall and typical nine-over-two windows, 3'-4" by 5'-10". The north window of the pair was badly damaged by the storm surge during Hurricane Isabel. The sash and most of the frame were knocked from the opening, but the sash were not destroyed.

Wood Trim: As noted above, a 4"-wide chair rail, unlike the others used in the building, surrounds the room at a height of about 41". Doors and windows are cased with a typical 4" molded casing and bull's-eye corner blocks, and doors have a typical 8" base block. The ceiling hatch to the second floor is also cased in a typical 4" molded casing but without corner blocks. The 7/8" by 3-1/2" baseboard surrounding the room is unique, consisting of a plain board with a V-shaped groove running the center of the board. The tool closet under the stairs has a 5" baseboard and cap like that used in Room 106. A 3" ogee crown molding trims the ceiling headers and walls.

Closets: The Boat Room's three closets appear to be original to the space, and all three have shelving that appears to be original. Built into the lower end of the



FIGURE 127. View east in Room 107. (T. Jones, NPS, 2005)

closet under the stairs is a three- drawer chest similar to those found in the crew's closets on the second floor. Although in poor condition, some of the building's only surviving plaster on wood lath is also found in the closet beneath the stairs.

Room 200 (Stair Hall)

Reached by the stairs from the first floor and providing access to the rooms on the second floor, this hall also contains the ladder- like stairs to the attic and the watch tower. The room measures about 6'-4" by 19'-11".

Flooring: Because of the difference in ceiling heights between Room 107 and the other rooms on the first floor, there is a change in floor level of about 15" in this room with a step spanning the width of the hall to accommodate the change. Flooring is a typical mixture of 2- 1/2" and 3" tongue- and- groove boards, all of it painted. Between the doors to Rooms 202 and 203 are the double doors for the hatch in the ceiling of Room 107. Measuring 35- 1/2" by 56- 1/2", the pair of doors could be opened to allow large items to be hoisted to the second floor without having to negotiate the main staircase.

Ceiling: The ceiling is plaster on plaster board, and with the change in floor levels, ceiling height ranges from about 9'- 5" at the head of the stairs to just over 8' at the doors to Rooms 202 and 203. At the northeast end of the space, the ceiling is open to the underside of the watch room floor, which is about 14" above the floor of the hall. The open floor joists and flooring for the attic landing is about 8' above the floor at that end of the hall and, with the open joists and flooring of the watch room floor form the ceiling at that end of the room.

Walls: Walls are also plaster on plaster board along with a 37"- high wainscot of 3" beaded tongue- and- groove boards like that in the hall (Room 105) below. Paint is peeling badly from some portions of the walls.

Doors: Three doors open out of this space into the three adjacent rooms. All are typical six- panel doors measuring 2'- 10" by 6'- 10". The door into Room 201 also has an 18"- high, three- light tilting transom. Escutcheons and knobs are missing from the doors to Rooms 202 and 203.



FIGURE 128. View northeast in Room 200. (T. Jones, NPS, 2005)



FIGURE 129. View southwest in Room 200. (T. Jones, NPS, 2005)

Physical Description



FIGURE 130. View from Room 200 of attic landing and stairs to watch room. (T. Jones, NPS, 2005)

Windows: The dormer window on the southeast side of the building lights the stairs from the first floor. The window measures 2'-10" by 4'-4" with sash that are double-hung, six-over-two. In addition, two smaller windows are located at the northeast end of the hall. Both are 2'-6" by 2'-7" with single, top-hinged, four-light sash, but all of the glass is missing. Although these windows open into the adjacent Rooms 202 and 203 and are now boarded up, they originally acted as "borrow lights" for the north end of the hall, being lit by the double-windowed dormer on the northeast side of the building.

Wood Trim: Woodwork in this room is typical. Doors and windows are trim with 4" molded casing and bull's-eye corner blocks and the doors have 8" base blocks. Three of the bull's-eye corner blocks at the small windows at the northeast end of the hall and one at the door to Room 203 are missing, and the dormer window above the stairs is missing both stool and apron. Although the wainscot has a chair rail like that used in Rooms 100, 104, and 105, there is no baseboard with the wainscot. On the attic landing, there is a 5" baseboard with 1-1/2" cap like that used in Rooms 106 and 201. Except for the missing



FIGURE 131. View east in Room 201. (T. Jones, NPS, 2005)

corner blocks, woodwork remains intact and in good condition.

Stairs: In addition to the regular staircase from the first floor, steep, ladder- like stairs ascend to a landing at the attic level, where similar stairs continue to the watch room above. These stairs have an overall width of 24", 1- 3/4" by 8- 1/2" stringers, and 1- 3/8" by 7" x 20- 1/2" treads. The hand railing is brass pipe 1- 1/4" in diameter.

Room 201 (Crew Quarters)

Occupying the northwestern half of the second floor, this large room is lined with single beds and small closets that originally served the station's crew. The room measures 22'- 2" by 24'- 4" plus a sort of alcove for the dormer window on the northwest side of the station. Entered directly from the hall (Room 200), it includes a series of eight identical closets that run along the northwest and southeast sides of the room. The chimney stack rises through the center of the room and is boxed in to a dimension of 24" by 48".

Flooring: Flooring is a typical mixture of painted 2- 1/2" and 3" tongue- and- groove boards.



FIGURE 133. View of typical closet door. (T. Jones, NPS, 2005)



FIGURE 132. View north in Room 201. (T. Jones, NPS, 2005)

Physical Description



FIGURE 134. View of door from Room 200 to 201. (T. Jones, NPS, 2005)



FIGURE 135. View west in Room 201. (T. Jones, NPS, 2005)

Walls: Walls are plaster on plaster-board, except in the closets where the original plaster on wood lath - remains intact, although much of the plaster has fallen from the lath.

Ceiling: The ceiling is plaster on plaster board.

Doors: The door from the hall is a typical six- panel door, 2'- 10" by 6'- 10", but also has a three- light transom. The transom originally tilted open, but the tilt mechanism is now missing. The eight closet doors are all 2'- 0" by 6'- 0" by 1- 1/2" with two, square- edged, raised panels. Unlike the other doors in the building, the closet doors here have separate escutcheons for the key hole and for the knob. The key escutcheon is rectangular, 1" by 1- 3/4", while the knob escutcheon is round, 2- 1/4" in diameter.

Windows: The room is lit by three windows, all double- hung with six- over- six sash. One is a dormer window on the northwest side of the room. The other two are located on the southwest wall, centered in the large gable at that end of the building.

Wood Trim: The room has typical 4" casing, bull's- eye corner blocks and base blocks at doors and windows. Baseboard is a 5" baseboard plus an 1- 1/2" ogee base cap, like that used in all of the rooms that



FIGURE 136. View of typical closet in Room 201. (T. Jones, NPS, 2005)

do not have wainscotting. In addition, a 5-3/4"-wide board with a series of coat hooks runs along the northeast and southwest walls at a height of six feet. Around the chimney breast, the board is surmounted by a 9-1/2" shelf, but there is no evidence that a similar shelf was ever present elsewhere.

Miscellaneous: Each of the closets has a small, built-in chest of drawers. Each has two drawers and measures 21" deep, 36" long, and 22" high. Birds nesting above the ceiling in the closets on the southwest side of the building have soiled the space with their droppings and contributed to damage to the plaster.

Room 202 (Spare Room)

Designated simply as a "spare room" on the building's original plans, this room would have been used to temporarily house ship-wrecked victims or storm refugees. The main portion of the room measures 9'-10" by 26'-2", plus the alcove formed by the dormer at the northeast end of the room. A low closet also runs along the knee wall at the northwest side of the room.



FIGURE 138. View of closet door in Room 202. (T. Jones, NPS, 2005)



FIGURE 137. View northeast in Room 202. (T. Jones, NPS, 2005)

Physical Description



FIGURE 139. View northwest in Room 203. (T. Jones, NPS, 2005)

Flooring: Unlike most of the other rooms in the station, all of the flooring in this room is 3" tongue-and-groove.

Walls: Walls are plaster on plaster board.

Ceiling: The ceiling is plaster on plaster board.

Doors: In addition to the large six-panel door from the hall (Room 200), there is a small, single-panel door to the closet on the northwest wall. The door measures 2'-2" by 3'-0".

Windows: In addition to the window that opens into this room from the northeast end of the hall (Room 200), one of the windows in the building's double dormer lights this room. It is a typical double-hung window with six-over-two sash and measures 3'-0" by 4'-5". Counterweight ropes are broken.

Wood Trim: Doors and windows are trimmed with typical 4" molded casing, bull's-eye corner blocks, and base blocks. The 5" baseboard and 1-1/2" ogee base cap are typical of those rooms that do not have a wainscot.



FIGURE 140. View southwest in Room 202. (T. Jones, NPS, 2005)

Miscellaneous: The wall below the dormer window has been severely damaged, apparently due to water penetration.

Room 203 (Store Room)

Designated for storage on the original plans for this type of building, this room originally had no wall or ceiling finishes. Fiberboard was later installed on the walls and ceiling. The room is approximately the same size as Room 202 and its closet combined.

Flooring: Flooring is a typical mixture of 2- 1/2" and 3" tongue- and- groove boards.

Walls and Ceiling: Walls and ceiling, which originally were open to the building's framing, were finished with fiber board in the mid- twentieth century. Only remnants of that material remain in place.

Door: The door that opens into this room from the hall is a six- panel door, 2'- 10" by 6'- 10", like the other principal doors on this floor.

Windows: As in Room 202, this room has two windows. One of the double dormer windows provided light for this room but is now boarded up. The six- over- two sash is in poor condition. Also as in Room



FIGURE 142. View damaged wall below window in Room 202. (T. Jones, NPS, 2005)



FIGURE 143. View of artifacts in Room 203; also note intact fiberboard walls and baseboard. (T. Jones, NPS, 2005)



FIGURE 141. View northeast in Room 203. (T. Jones, NPS, 2005)

Physical Description



FIGURE 144. View northeast in attic. (T. Jones, NPS, 2005)

202, opposite the dormer window, there is a borrow light for the adjacent hall (Room 200). It, too, is missing all glass and is boarded over.

Trim: Wooden casing, baseboard, and other trim were not used in this room. Instead, when the fiberboard walls and ceiling were installed, 4"-wide strips of fiberboard were used for casing and baseboard. Most of that material is now missing.

Miscellaneous: A number of pieces of furniture and other items have been stored in this room, including parts of an antique kerosene lamp and old pumps that may have been used at the station.

Attic

At the northeast end of Room 200, the ceiling is open to the underside of the watch tower floor, which is about 14' above the floor of Room 200. The ladder-like stairs from the second floor described above, rise to a small landing that is about 3'-11" by 6'-2". Opening on the northwest side of that landing is the door to the floored portion of the attic. The attic floor space is about 15'-3" wide and some 34'-8" long.

Flooring: The landing at the attic door is floored with 3" tongue- and- groove boards. The attic itself



FIGURE 145. View southwest in attic. (T. Jones, NPS, 2005)

is floored with plain boards, 7/8" by 11-1/4" to 11-1/2" wide, installed with machine-cut nails.

Door: The door from the landing into the attic is a four-panel door, 2'-6" by 5'-6". It is the only door in the building that retains its original varnished finish and has not been painted. It is fitted with a simple thumb latch, which is probably original.

Window: A single window in the southwest gable lights the attic. It is the only two-over-two window in the building and measures 2'-4" by 3'-5". Because the interior of the sash has never been painted or varnished, there has been significant UV degradation of the soft wood.

Miscellaneous: A wide range of furniture and other artifacts are stored in the attic. These include window sash and screen, some of which may belong to this building. Other artifacts, including roof shingles, are tagged to indicate they came from the church or other historic buildings in Portsmouth.

Watch Room

Another ladder rises from the landing at the attic door to the watch room. The watch room, which has windows on all four sides, is 6' by 9'-9" with a ceiling height of 7'-6".



FIGURE 146. View of attic door. (T. Jones, NPS, 2005)



FIGURE 147. View of second floor hall (Room 200) from attic landing. (T. Jones, NPS, 2005)



FIGURE 148. View north of attic landing and stairs to watch room from attic door. (T. Jones, NPS, 2005)

Physical Description



FIGURE 149. View northeast of watch room. (T. Jones, NPS, 2005)

Flooring: Flooring is painted, 3"- wide, tongue- and- groove. A small area of water- damaged flooring in the west corner of the room is covered with plywood.

Walls: Walls are finished with a wainscot of 3"- wide beaded tongue- and- groove boards installed vertically and a chair rail at 52" above the floor. Above the chair rail, walls are finished with the same 3"- wide material, but installed horizontally.

Ceiling: The ceiling is finished with the same 3"- wide beaded material used on the walls.

Door: The door or hatch in the floor, which provides the only access into the room, is 26- 1/2" by 44". It has a frame made of 7/8" by 5" boards and is covered by the same 3" tongue- and- groove material used on the floor. The opening is surrounded on three sides by a 1- 5/8"- diameter brass pipe rail, 33" high.

Windows: The room has seven windows, not eight as shown on some plans of the building. Two are located on each of the northwest, southwest, and southeast walls, with one located on the northeast wall. Sash are 20- 1/2" by 28", top hinged, and divided into three lights. Both sash are missing from

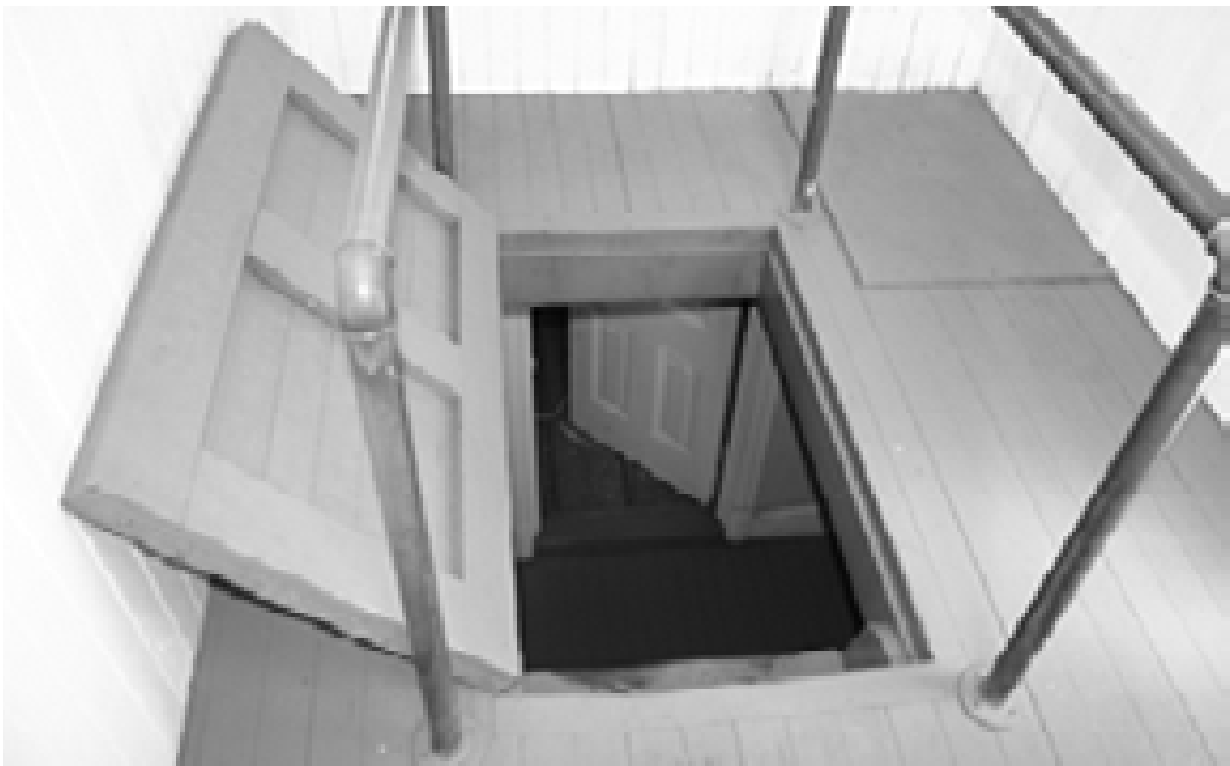

FIGURE 150. View west of watch room's hatch door. (T. Jones, NPS, 2005)

the two windows on the northwest side of the room, and the openings are now covered by plywood.

Woodwork: Windows are cased with 3"- wide reeded boards not found anywhere else in the building. Corner blocks are plain, not the bull's-eye blocks used elsewhere in the building. There is no baseboard, but there is a 3" crown molding at the top of the walls.

Miscellaneous: A small wooden box is mounted on the east corner of the room and may have once held the time clock used to record the watchman's time on duty. For unknown reasons, a 6" by 8" hole has been opened in the southeast wall and a portion of the chair rail is missing in that location.



FIGURE 151. View of east corner of room. (T. Jones, NPS, 2005)

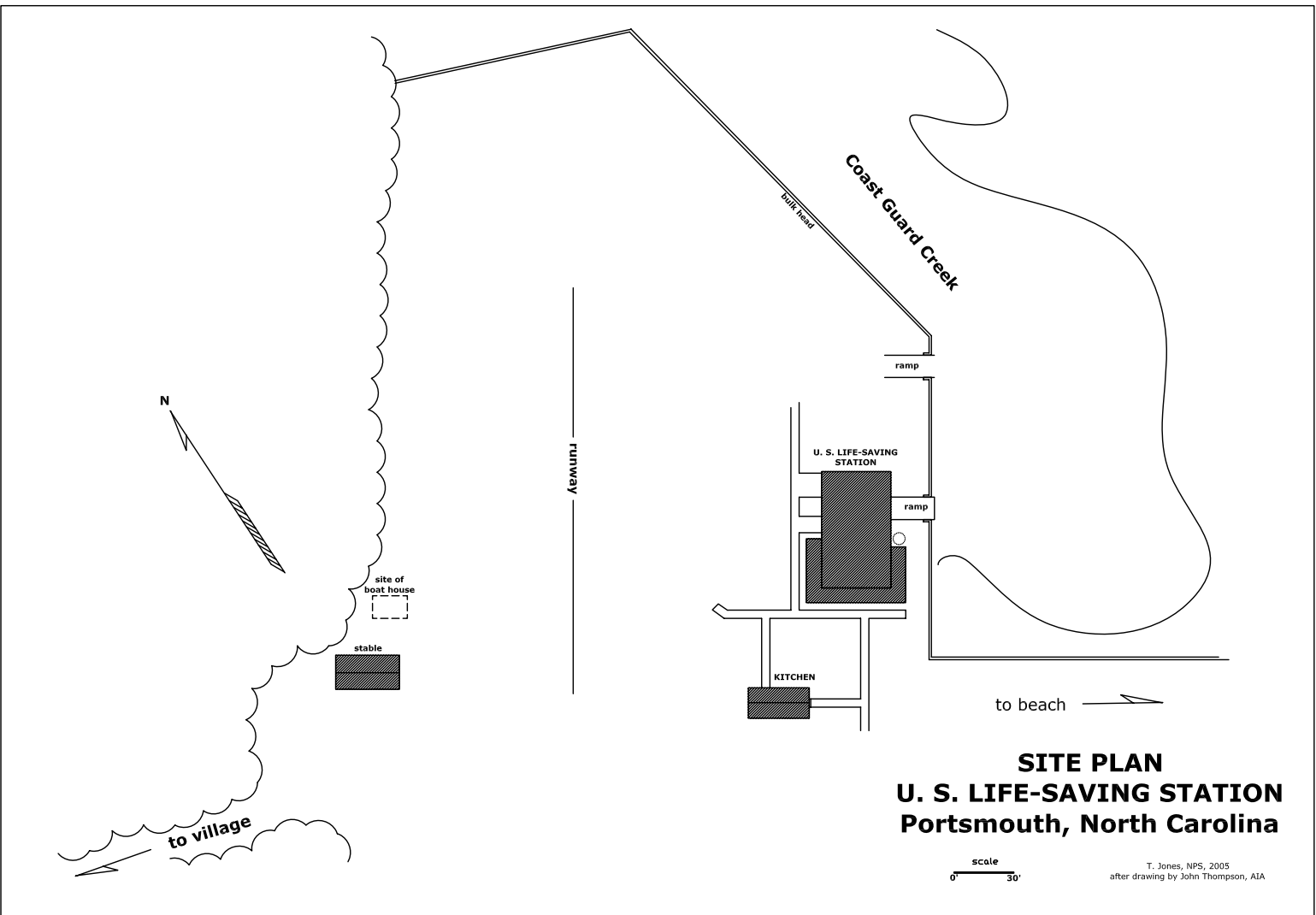

FIGURE 152. View northwest of Portsmouth village from watch room. (T. Jones, NPS, 2005)

Physical Description

Plans of Existing Building

Site Plan



Physical Description

First Floor Plan

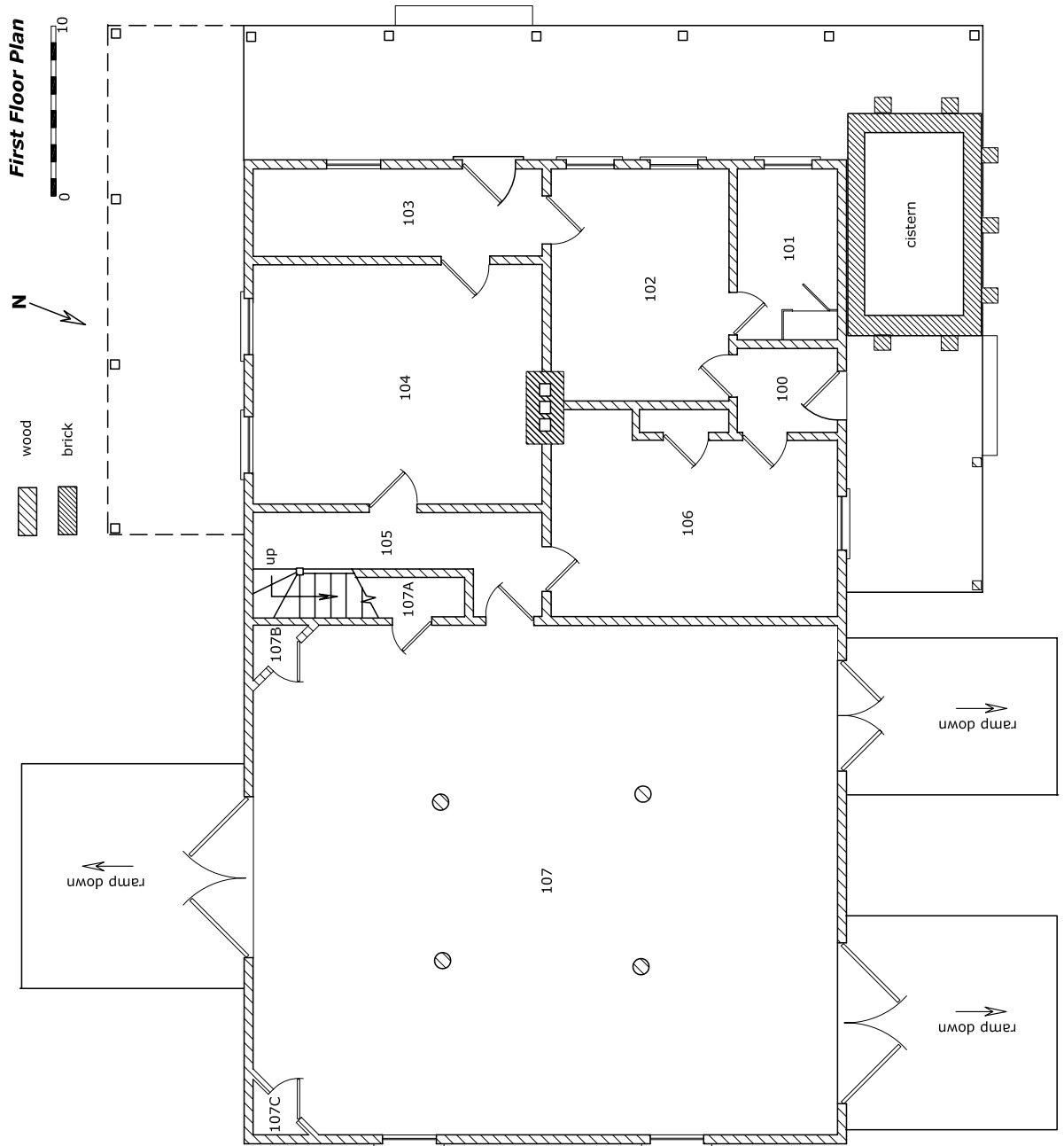

Physical Description

Second Floor Plan

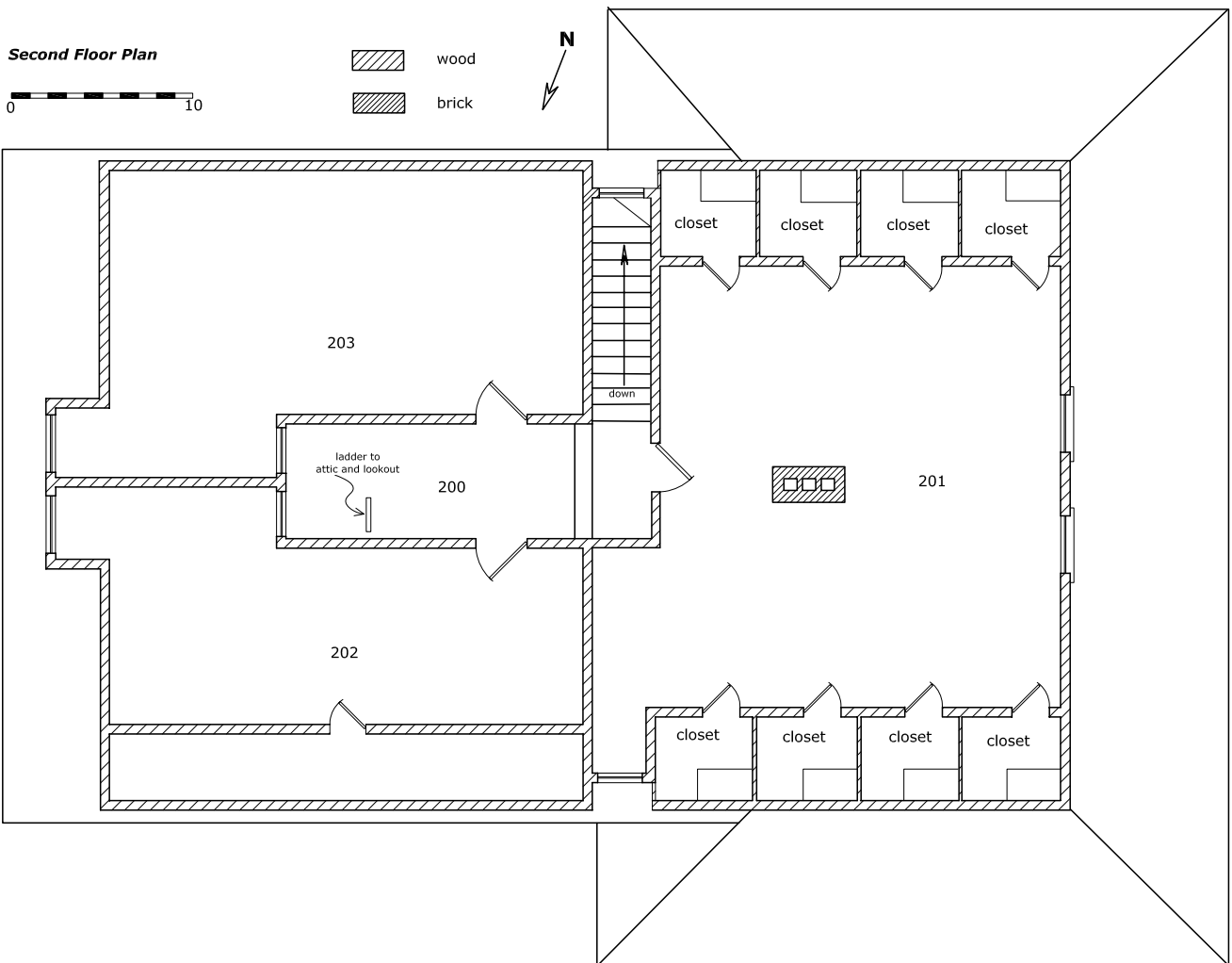

Physical Description

Attic Floor Plan

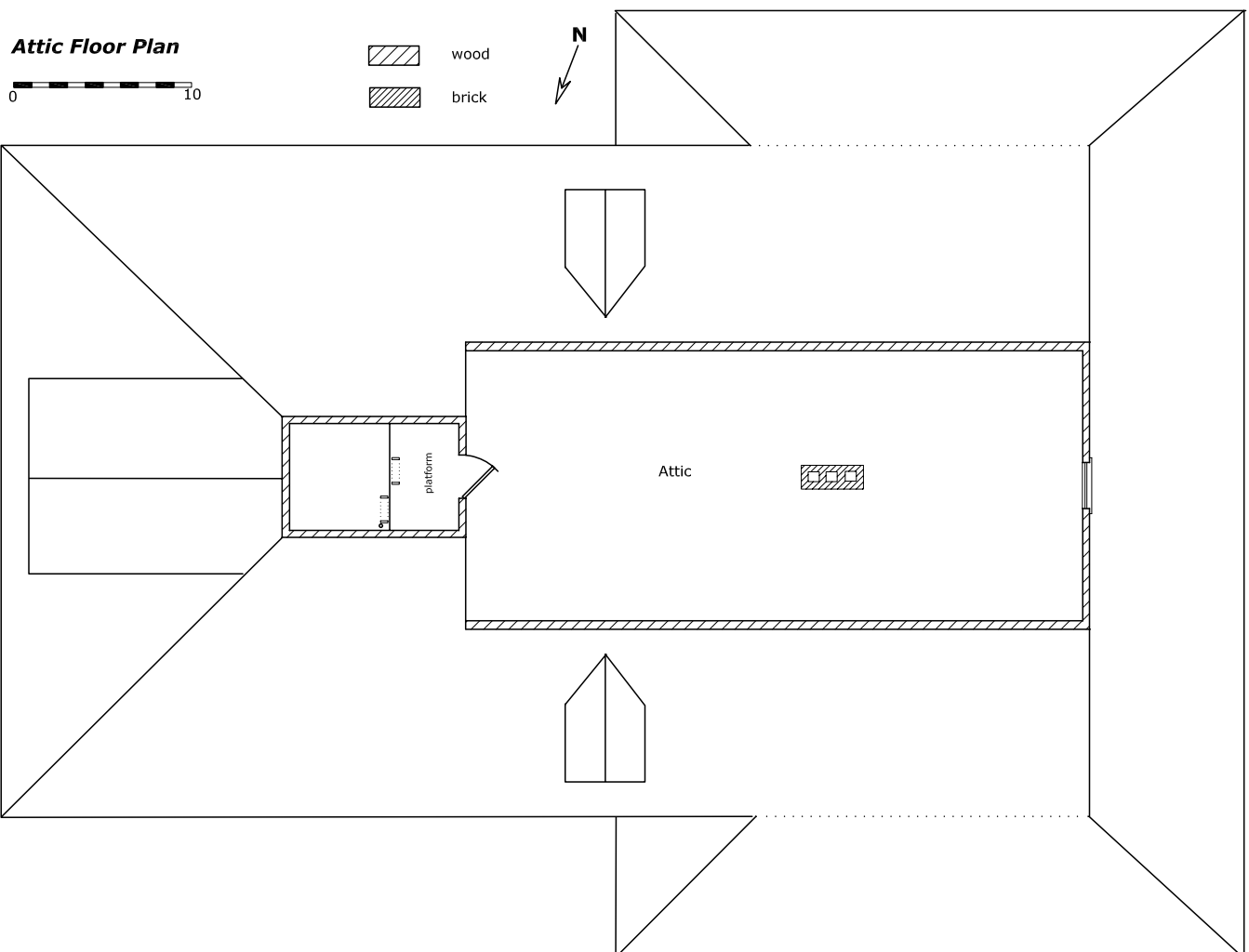

Physical Description

Watch Room and Roof Plan

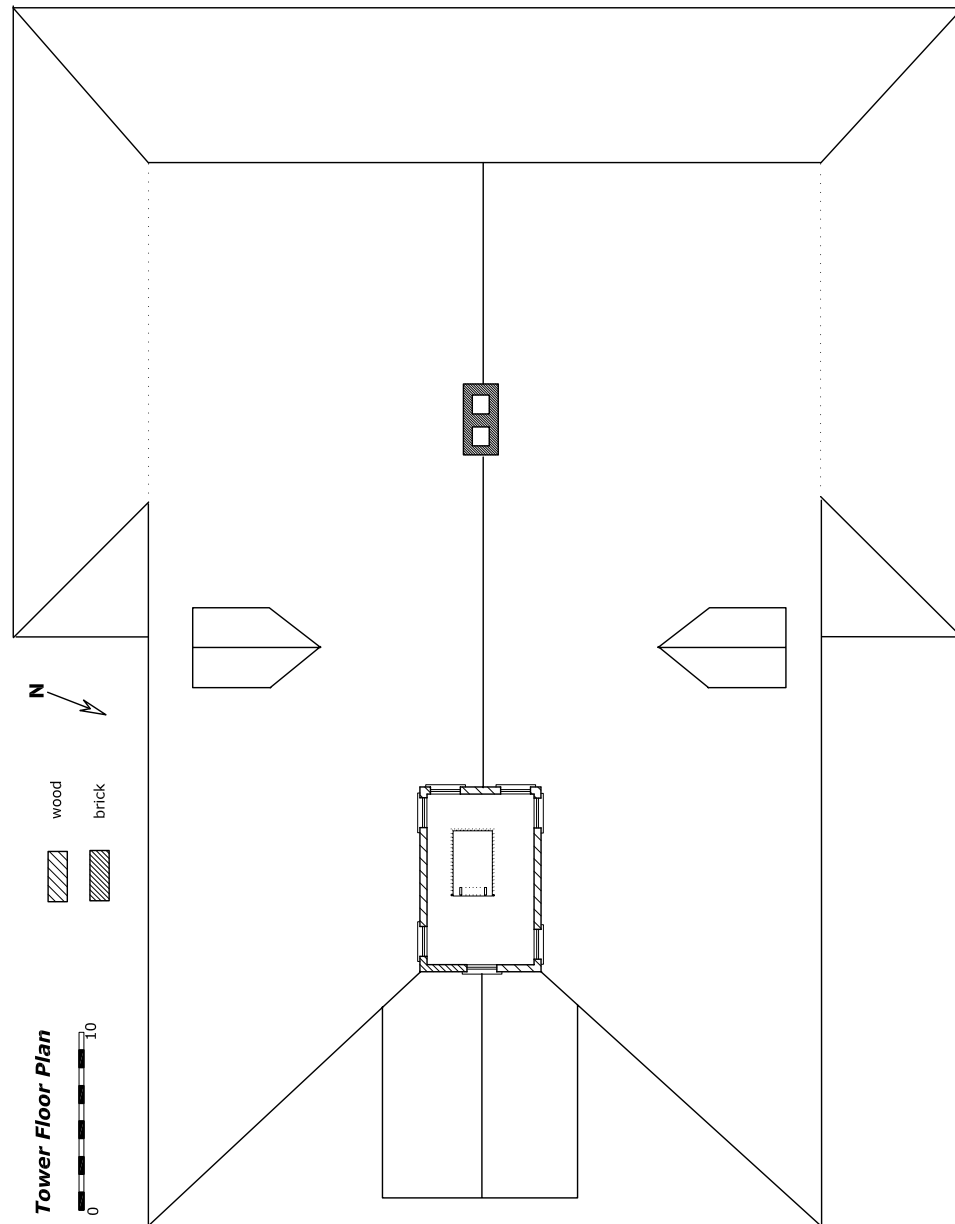

Physical Description

Molding Profiles

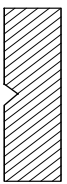
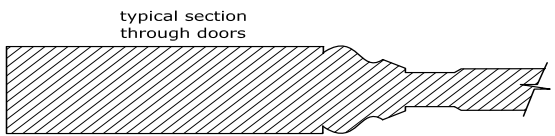
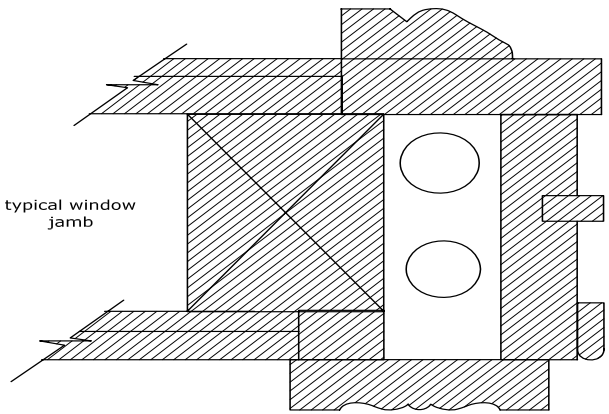

baseboard in Room 107

baseboard in Rooms 106, 200, 201, 202, and closet in 107

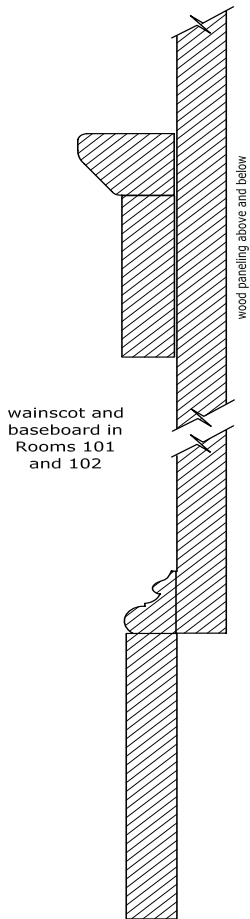
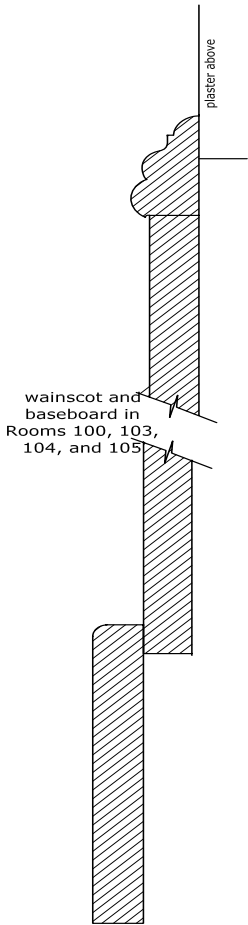
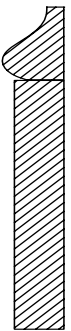

panelling in wainscot at Rooms 100, 103, 104, 105, and 106

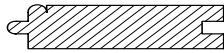

chair rail in watch room

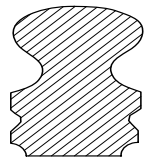
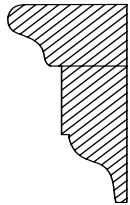

balustrade railing



Physical Description

Treatment and Use

The Portsmouth Life- Saving Station is a relatively rare example of Shingle- Style architecture in the southern United States and is the best- preserved of the twenty- one Quonochontaug- type stations that the U. S. Life- Saving Service constructed between 1891 and 1904, only ten of which remain in existence today. The station played a major role in the history of Portsmouth and helped keep the village viable into the twentieth century. From its construction in 1894 until it was finally decommissioned in 1946, the station was a source of shelter during storms and of assistance during all kinds of emergencies, and it has remained a major landmark on the Outer Banks to the present day.

Well constructed, the building has had relatively few alterations and remains, for the most part, structurally sound. However, a series of storms, including hurricanes in 2001 and 2004, has taken its toll on the

building and caused major damage, especially around the north corner of the building. The Portsmouth Life- Saving Station is one of the park's most- significant historic resources and is indispensable for interpretation of the history of Portsmouth in the late nineteenth and early twentieth centuries.

Requirements for Treatment and Use

The authorizing legislation (Public Law 89- 366) for Cape Lookout National Seashore mandated the park's establishment for the purpose of preserving "for public use and enjoyment an area in the State of North Carolina possessing outstanding natural and recreational values." Shortly after the seashore was



actually established in 1976, the cultural resources at Portsmouth were also recognized through listing of the Portsmouth Village Historic District on the National Register of Historic Places. The general management plan (GMP) developed for the park by the Denver Service Center in 1982 states that one of the park's management objectives is "[t]o preserve intact, as feasible, the historic resources of the national seashore and to recognize that dynamic natural forces have influenced them throughout their existence and will continue to influence them."⁹⁶ The GMP envisioned interpretation of the park's cultural resources that would "emphasize man and his relation to the sea" with maritime history a focus at the [Cape Lookout] Lighthouse and the cultural and economic life of the Outer Bankers at Portsmouth Village."⁹⁷

The key to the success of any historic preservation project is good judgement in determining where replacement of a deteriorated building element is necessary. Deterioration in part of an element should not necessitate total replacement of the element, since epoxy consolidants and fillers can often be used to repair the damaged area, often without even removing the damaged element to make the repair. While total replacement of a damaged element is often recommended, especially in rehabilitation projects, the success of most preservation projects can be judged by the amount of historic material that remains. Even "replacement in kind" does not typically address natural processes that give the historic materials an aged appearance that cannot be duplicated except by the passage of time.

Because it is a contributing building in a National Register district, legal mandates and policy directives circumscribe treatment of the Life-Saving Station. The NPS' Cultural Resources Management Guideline (DO- 28) requires planning for the protection of cultural resources "whether or not they relate to the specific authorizing legislation or interpretive programs of the parks in which they lie." Therefore, the building should be understood in its own cultural context and managed in light of its own values so that it may be preserved unimpaired for the enjoyment of present and future generations.

To help guide compliance with legal mandates and regulations while still maintaining the building's

96. Cape Lookout GMP, p. 4.

97. Ibid.

historic integrity, the Secretary of the Interior's Standards for the Treatment of Historic Properties have been issued along with guidelines for applying those standards. Standards are included for each of the four separate but interrelated approaches to the treatment of historic buildings: preservation, rehabilitation, restoration, and reconstruction. These approaches define a hierarchy that implies an increasing amount of intervention into the historic building. Rehabilitation, in particular, allows for a variety of alterations and even additions to accommodate modern use of the structure. NPS *Management Policies* permits restoration only if (a) it is essential for public understanding of the cultural associations of a park and (2) it can be accomplished with minimal conjecture based on sufficient data. Restoration of prehistoric or historic ruins is prohibited. Regardless of approach, a key principle embodied in the Standards is that changes be reversible, i.e., that alterations, additions, or other modifications be designed and constructed in such a way that they can be removed or reversed in the future without the loss of existing historic materials, features or characters.

Treatment of the building should be guided by the International Building Code, including that code's statement regarding historic buildings:

3406.1 Historic Buildings. The provisions of this code related to the construction, repair, alteration, addition, restoration and movement of structures, and change of occupancy shall not be mandatory for historic buildings where such buildings are judged by the building official to not constitute *a distinct life safety hazard* [emphasis added].

Threats to public health and safety will be eliminated, but because this is an historic building, alternatives to full code compliance should be identified where full compliance would needlessly compromise the integrity of the historic building.

Alternatives for Treatment and Use

Because of the building's distinctive architecture and the major role that the station played in the history of Portsmouth, treatment and use of the building should preserve the building's historic character as it evolved through World War II.

Use

A use that requires significant alterations to the building's historic interior, which remains in relatively good condition, should not be considered. Use of the life-saving station for overnight accommodations for volunteers could be considered if improvements were kept to a minimum. However, installation of full bathroom facilities, central heating and air-conditioning, and other amenities would require significant alterations to the building that could diminish its integrity as an historic resource.

Treatment

Most of the building's distinctive materials, features, and spaces are essentially intact, and in spite of alterations, the building retains its historic integrity. Repair and preservation of the building in its current state is a valid approach to treatment. Restoration of the building to earlier appearances might be considered as well, but only within the context of the park's interpretive goals for the entire historic district.

Preservation. Much of the work to simply repair and preserve the building is already underway as part of repair of storm damage that has occurred over the last few years. This approach does not attempt to restore or recreate lost features, such as the porch floor at the south corner of the building, but aims only to preserve the building in more or less its existing state.

Rehabilitation. Rehabilitation of the building would include all of the repairs necessary to stabilize and preserve the building in its existing state. This approach would be coupled with adaptive use which would probably require installation of modern HVAC, electrical, and plumbing systems in the building.

Restoration. While there have been relatively few changes to the Portsmouth Life-Saving Station since it was deactivated at the end of World War II, restoration as an approach to treatment could be pursued with a goal of returning the building to its appearance at four main points in its evolution as an historic building.

1945 Restoration: Restoration of the building to its appearance when it was decommissioned at the end of World War II.

- reconstruct missing section of porch
- install screening on southwest (facing the kitchen) and southeast (facing creek) sides of porch; leave cistern side of porch unscreened
- install half screens at windows
- recreate washrooms but no toilet in old pantry (101) and storm clothes room (103); administrative office for commanding officer in old kitchen (102)
- reinstall metal cistern
- replace shingles with siding on addition to summer kitchen; maintain shingles on original portion of summer kitchen; paint entire building white

1937 Restoration: Restoration of the building to its appearance when it was first decommissioned by the Coast Guard

- reconstruct missing section of porch
- install half screens at windows and screen doors at exterior doors
- recreate "washrooms" in 101 and 103, but no kitchen in 102
- recreate washrooms but no toilet in old pantry (101) and storm clothes room (103); administrative office for commanding officer in old kitchen (102)
- reinstall metal cistern
- remove c. 1942 addition to summer kitchen

1915 Restoration: Restoration of the building to its appearance when it became a Coast Guard station

- reconstruct missing section of porch
- install half screens at windows and screen doors at exterior doors
- remove V-joint paneling from 101 and 102; reconstruct door opening between 102 and 104; and restore original finishes
- remove partition from 103
- install sink in kitchen (102) and in storm clothes room (103)
- remove gun cabinet from 101 and reconstruct shelving, etc.
- recreate pantry in 101, kitchen in 102, mess room in 104
- remove c. 1942 addition to summer kitchen

1894 Restoration: Restoration of the building to its original appearance

- reconstruct missing section of porch

- replace concrete boat ramps with wooden ramps
- remove V- joint paneling from 101 and 102; reconstruct door opening between 102 and 104; and restore original finishes
- remove partition from 103
- determine character of original door locksets and knobs and replace existing hardware
- install half screens at windows and screen doors at exterior doors
- install sink in kitchen (102)
- remove gun cabinet from 101 and reconstruct shelving, etc.
- recreate pantry in 101, kitchen in 102, mess room in 104
- remove summer kitchen (built in 1908)

Ultimate Treatment and Use

Use

When the park's current General Management Plan (GMP) was developed in 1982, the Life- Saving Station was being used as a residence for park personnel. That use was discontinued around 1990, and the building has been occupied only sporadically since that time. The park is presently planning presentation of the building as a museum to exhibit both the building's architecture and its use as a life-saving station. The historical significance of the Life- Saving Station and the quality and scale of its architecture insures a high level of public interest in the building.

Treatment

Unlike most of the other structures at Portsmouth, which are simple vernacular buildings, the old Life-Saving Station is a significant example of historic architecture designed and later modified by the government for specific uses. It is the best-preserved of the few life- saving stations of this type that remain along the East Coast and has the potential to be the centerpiece of the park's interpretation of the United States Life- Saving Service and Coast Guard as well as a major point of interpretation of the village of Portsmouth itself.

The park is presently planning presentation of the building as a museum to exhibit both the building's architecture and its use as a life- saving station. The historical significance of the Life- Saving Station and the quality and scale of its architecture insures a high level of public interest in the building. Because of the building's architectural significance, the few unsympathetic alterations to the building that occurred after World War II should be reversed. The interior of the building should be repaired as necessary and preserved in more- or- less its present condition.

Much of this work is presently underway as part of repair of hurricane damage that has occurred over the last five or six years. All of the issues raised in this section are necessary for the continued preservation of the building and should be addressed regardless of the use to which the building is put.

Sources of Information

Published Sources

- Canney, Donald L., "Rum War: The U. S. Coast Guard & Prohibition," accessed on line at <http://www.uscg.mil/hq/g-cp/history/h_rumwar.html>, November 18, 2005.
- Chenery, Richard L. *Old Coast Guard Stations, Volume II, North Carolina*. Glen Allen, VA: Station Books, 2000.
- Dunbar, Gary S. *Historical Geography of the North Carolina Outer Banks*. Baton Rouge, LA: Louisiana State University Press, 1958.
- Ehrenhard, John E. *Cape Lookout National Seashore: Assessment of Archaeological and Historical Resources*. NPS: Southeast Archaeological Center, Tallahassee, FL, 1976.
- Greene, Jerome A. *Historic Structure Report, Historical Data Component, Little Kinnakeet Life-Saving Station, Cape Hatteras National Seashore, North Carolina*. National Park Service, 1987.
- Holland, F. Ross. *A Survey History of Cape Lookout National Seashore*. NPS: Division of History, Office of Archaeology and Historic Preservation, January 30, 1968.
- Merryman, J. H. "The United States Life-Saving Service." *Scribner's Monthly*. Vol. 19, #3, January 1880, pp. 321-338. Accessed at <<http://cdl.library.cornell.edu/cgi-bin/moa/pageviewer?coll=moa&root=/moa/scmo/scm00019/&tif=00339.TIF&view=50&frames=1>> 17 November 2005.
- Means, Dennis R. "A Heavy Sea Running: The Formation of the U.S. Life-Saving Service, 1846-1878." *Prologue: Journal of the National Archives*, Winter 1987, Vol. 19, #4. <http://www.chicamacomico.org/Library/heavy_sea_running.html> (November 2002).
- National Park Service. *Cape Lookout General Management Plan/Development Concept Plan*. Denver Service Center: December 1982.
- National Park Service. *Cape Lookout National Seashore: Amendment to General Management Plan and Environmental Assessment*. Southeast Regional Office: January 2001.
- Noble, Dr. Dennis L. "A Legacy: The United States Life-Saving Service." November 2001. <http://www.uscg.mil/hq/g-cp/history/h_USLSS.html> (November 2002).
- Olds, Fred A. "The Barrier Reef;" *The Orphan's Friend and Masonic Journal* (Oxford, NC), October 28, 1921.
- Ruffin, Edmund. *Agricultural, Geological, and Descriptive Sketches of Lower North Carolina, and the Similar Adjacent Lands*. Raleigh, NC: Institution for the Deaf & Dumb & The Blind, 1861. <http://docsouth.unc.edu/nc/ruffin/ruffin.html> (November 2002).
- Salter, Ben B. *Portsmouth Island, Short Stories and History*. Privately published, 1972.
- Shanks, Ralph, Wick York, and Lisa Woo Shanks. *The U. S. Life-Saving Service: Heroes, Rescues, and Architecture of the Early Coast Guard*. Petaluma, CA: Costano Books, 1996.
- Stick, David. *The Outer Banks of North Carolina*. Chapel Hill: University of North Carolina Press, 1958.
- United States Coast Guard. "Search and Rescue: The Coast Guard and the U. S. Life-Saving Service." Updated March 2002. <http://www.uscg.mil/hq/g-cp/history/h_USLSS.html> (November, 2002).
- United States Coast Guard, Journals of Portsmouth Life-Saving Station, 1894-1937. (Original volumes at National Archives, Morrow, GA.
- Whittier, Bob. "The History of Outboards," *Yachting Magazine* (January 1957). Accessed at <<http://www.acbs.org/Public/Rudder/Fall2001/OutboardHistory.htm>> 25 May 2005.
- York, Eugene V. "The Architecture of the United States Life-Saving Service. Undergraduate Thesis, Boston University, 1972

Historic Drawings

- U.S. Life-Saving Service, "Plat of U. S. Marine Hospital Reservation at Portsmouth, NC" July 7, 1893. RG 26, National Archives and Records Center in Philadelphia, PA.

U.S. Life- Saving Service, "Position Plan for Buildings of the U. S. Life- Saving Station at Portsmouth, NC," N.D., probably 1894. RG 26, National Archives and Records Center in Philadelphia, PA.

U.S. Life- Saving Service, "Fence for the Portsmouth, N.C. Life- Saving Station" N.D., probably 1894. RG 26, National Archives and Records Center in Philadelphia, PA.

U.S. Life- Saving Service, "[Plot of]U. S. Life- Saving Station Portsmouth, N. C.," December 17, 1900. National Archives and Records Center, Cartographic Division, College Park, MD.

U.S. Life- Saving Service, "Plot of Lot of U.S. L- S.S., Portsmouth, N. C., 7th Dist.," June, 1903, with "new data added" on July 26, 1909. RG 26, National Archives and Records Center, Cartographic Division, College Park, MD.

U.S. Life- Saving Service, "Harbor and Proposed Location for Wharf," March 1913. RG 26, National Archives and Records Center in Philadelphia, PA.

U.S. Life- Saving Service, "Details of Walk and Wharf, and Profile Showing Ground and Wharf Elevations," April 1913. RG 26, National Archives and Records Center in Philadelphia, PA.

U.S. Life- Saving Service, "Sketches for Boathouse Showing Basin Hoisting Gear and Boat in House," April 1913. RG 26, National Archives and Records Center in Philadelphia, PA.

U.S. Life- Saving Service, "End Section of Concrete Sheet Piles," July 9, 1914. RG 26, National Archives and Records Center in Philadelphia, PA.

U.S. Coast Guard, "Drawing of Walk," April 3, 1916. RG 26, National Archives and Records Center in Philadelphia, PA.

U.S. Coast Guard, "Portsmouth Station" [plans of first and second floors], N. D., probably 1916. RG 26, National Archives and Records Center in Philadelphia, PA.

Historic Photographs

Cape Lookout National Seashore has a large collection of historic photographs of the building, the oldest dating to around 1910. Unless otherwise noted, all of the historic photographs were taken from this collection.

Appendix A

Historic Drawings

"Plat of U. S. Marine Hospital Reservation at Portsmouth, NC" July 7, 1893.

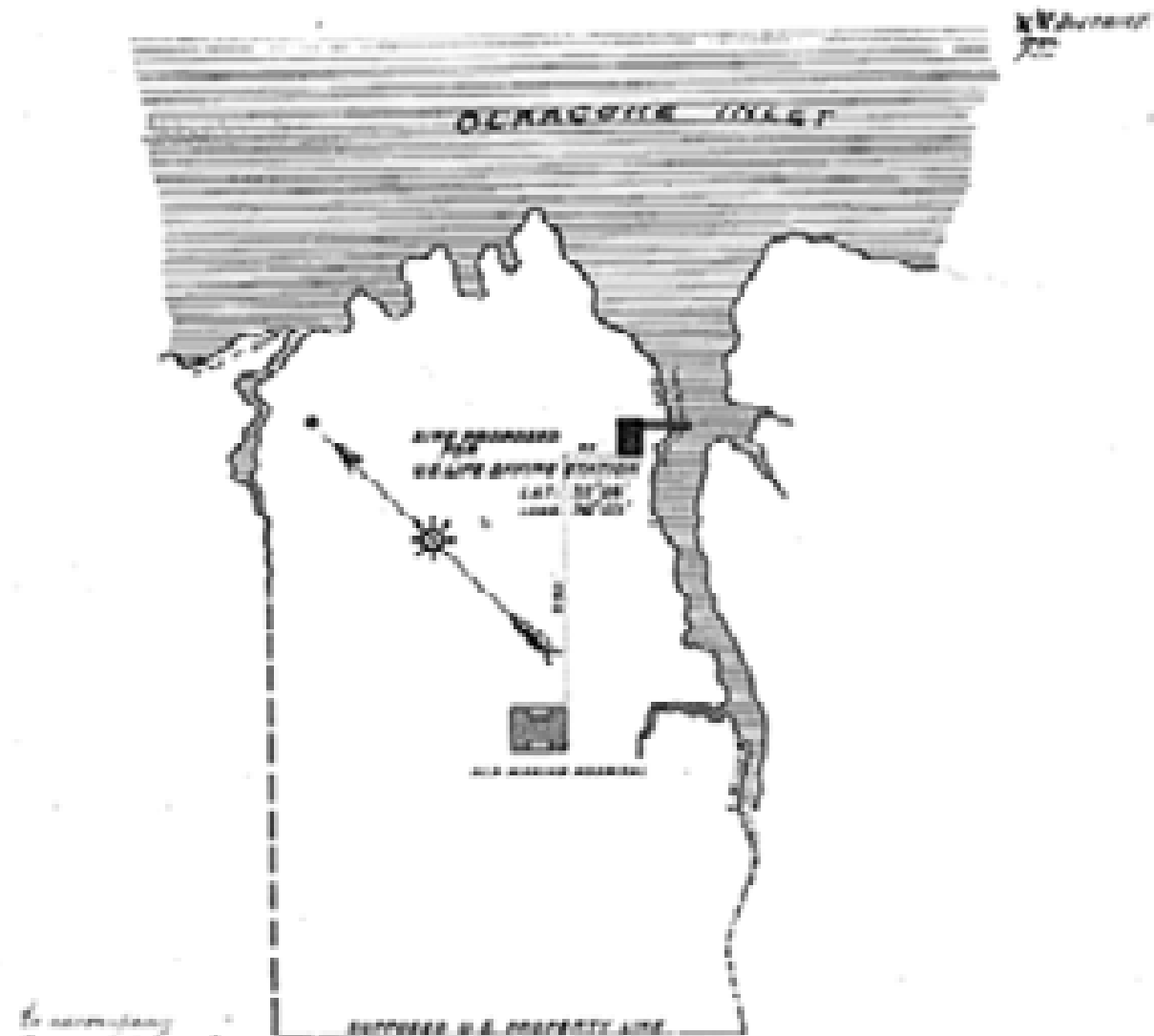

PLAT OF U. S. MARINE HOSPITAL RESERVATION
AT PORTSMOUTH, N. C.
SHOWING SITE PROPOSED FOR A
U. S. LIFE SAVING STATION

SCALE 100 Ft. = 1 inch

DRAWN BY J. H. ...

J. H. ...
1893

5-Point

"Position Plan for Buildings of the U. S. Life-Saving Station at Portsmouth, NC," N.D., probably 1894.

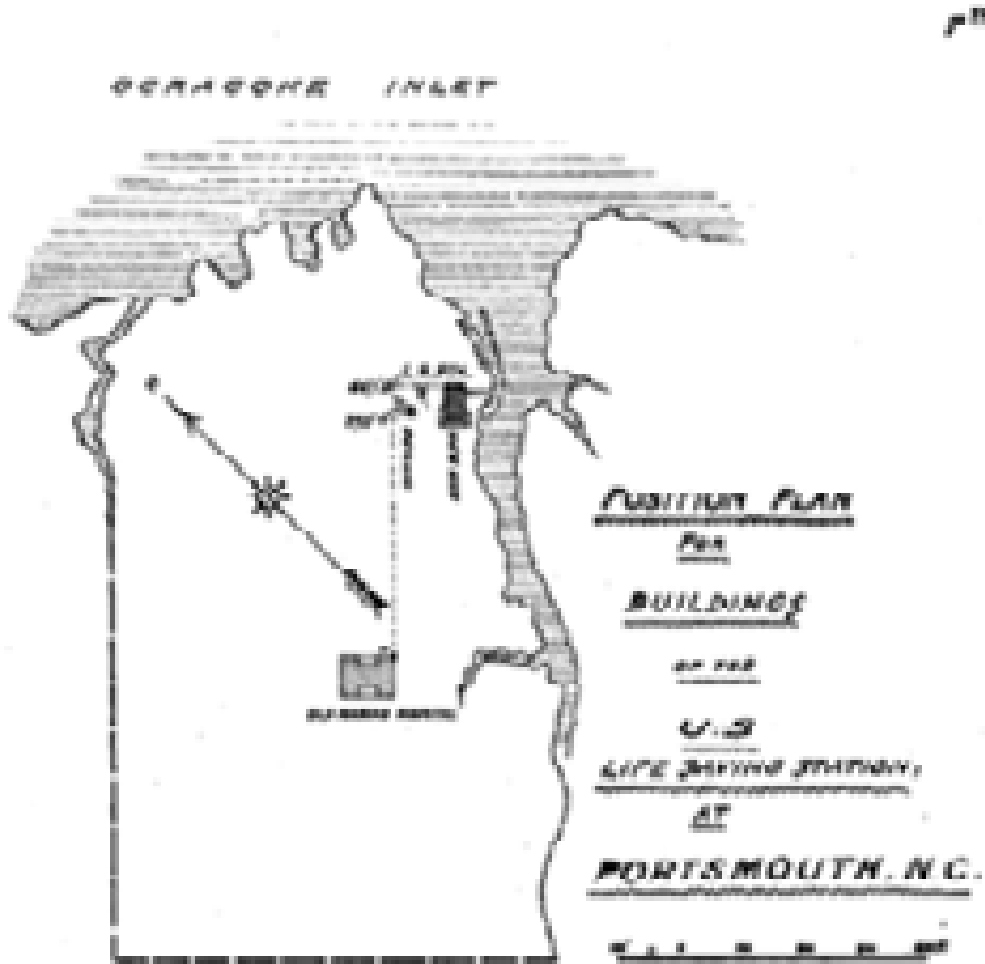

*Fence for the
Portsmouth, N.C.
Life-Saving Station.*

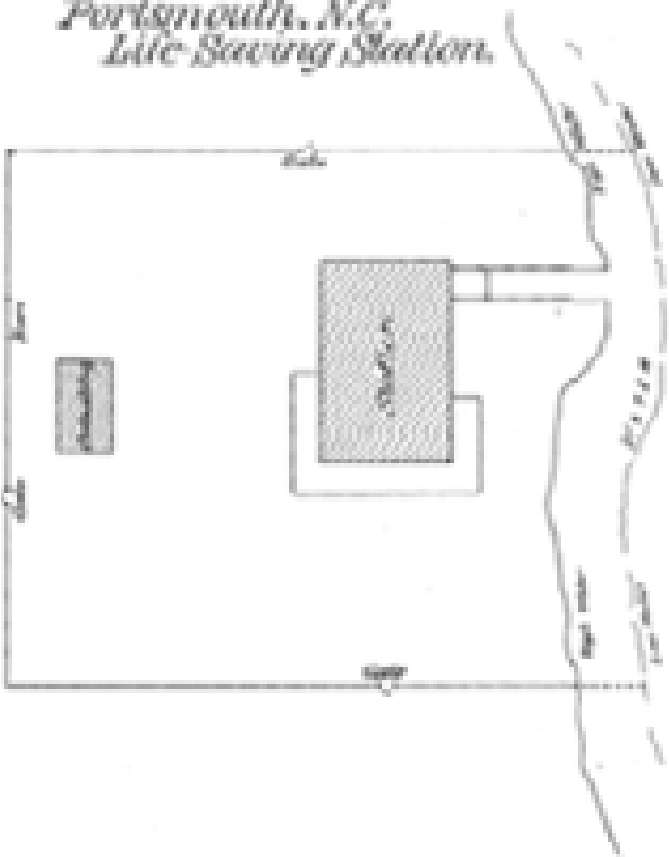

Specifications: For a fence (with gate and door) around three sides of the
Rectangular Life-Saving Station as indicated with the enclosed plan.

The fence shall be made of iron pipe and shall be set on the three sides of a square
water forming the other side and the ends of the fence to reach low water mark. The posts
to be of iron about four feet thick at bottom in diameter at the lower end, a four inch iron
length fixed on one side to receive railing. There to be used in the ground 4 feet 6 inches
wide and to extend four square feet area. The spacing of the posts shall be twenty
feet across the bottom of the lower pipe to be 4 inches from the ground. There to be used
to each post with 4 temporary rails. There to be used in the fence, there shall be 4 temporary
iron rail each end one set of 4 inch bars of yellow pine bark placed where indicated and one
placed in place with the wire. Each gate to have two 4 inch iron strap hinges and
have two lock and bolt.

All work and material to be of the best character and satisfactory to approved
by Government Officer.

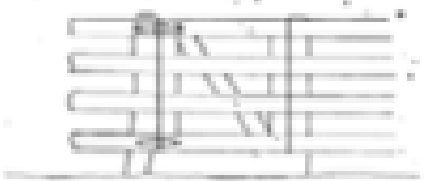

5-1209-6

"[Plot of]U. S. Life-Saving Station Portsmouth, N. C.," December 17, 1900.

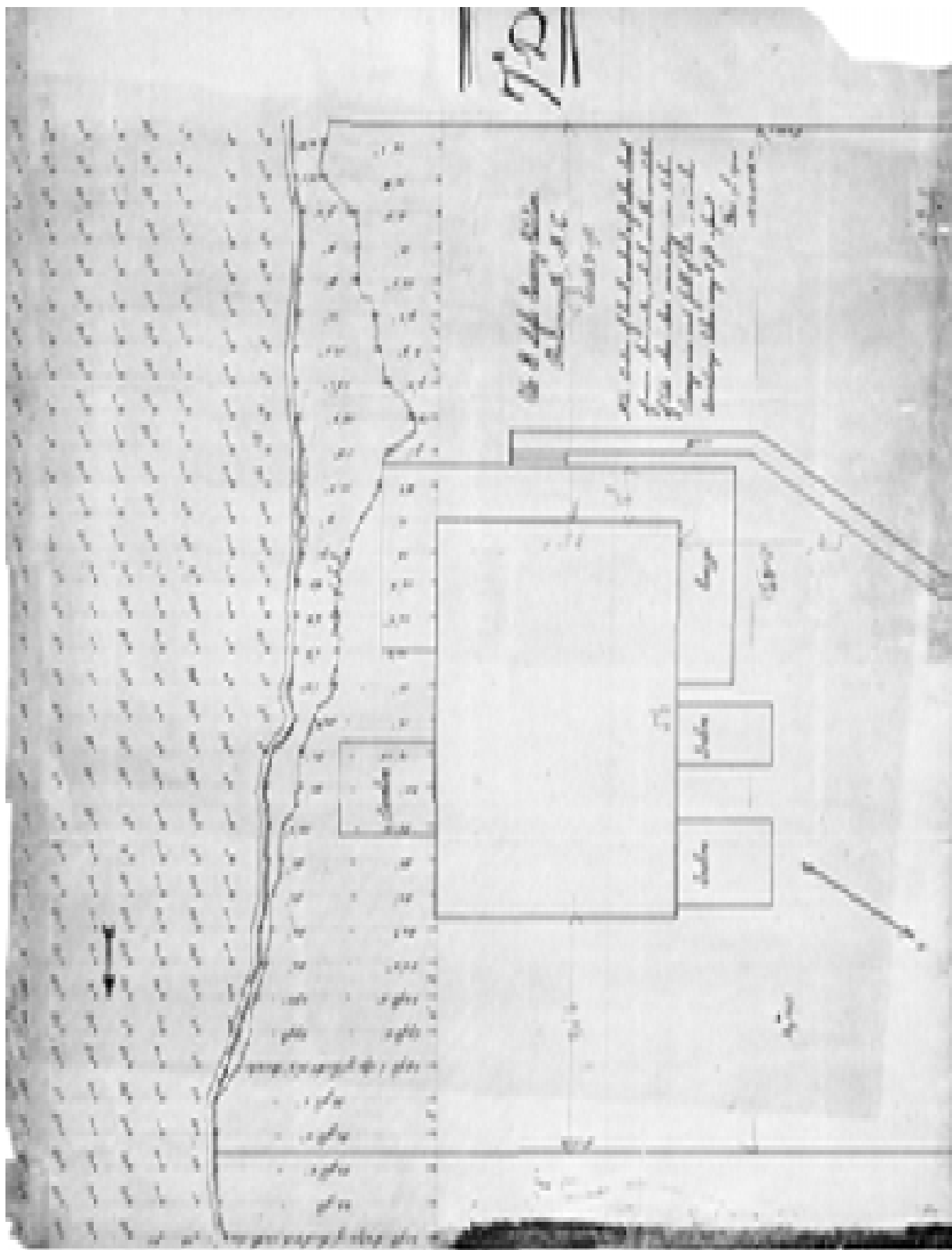

"Plot of Lot of U.S. L-S.S., Portsmouth, N. C., 7th Dist.," June, 1903, revised July 26, 1909.

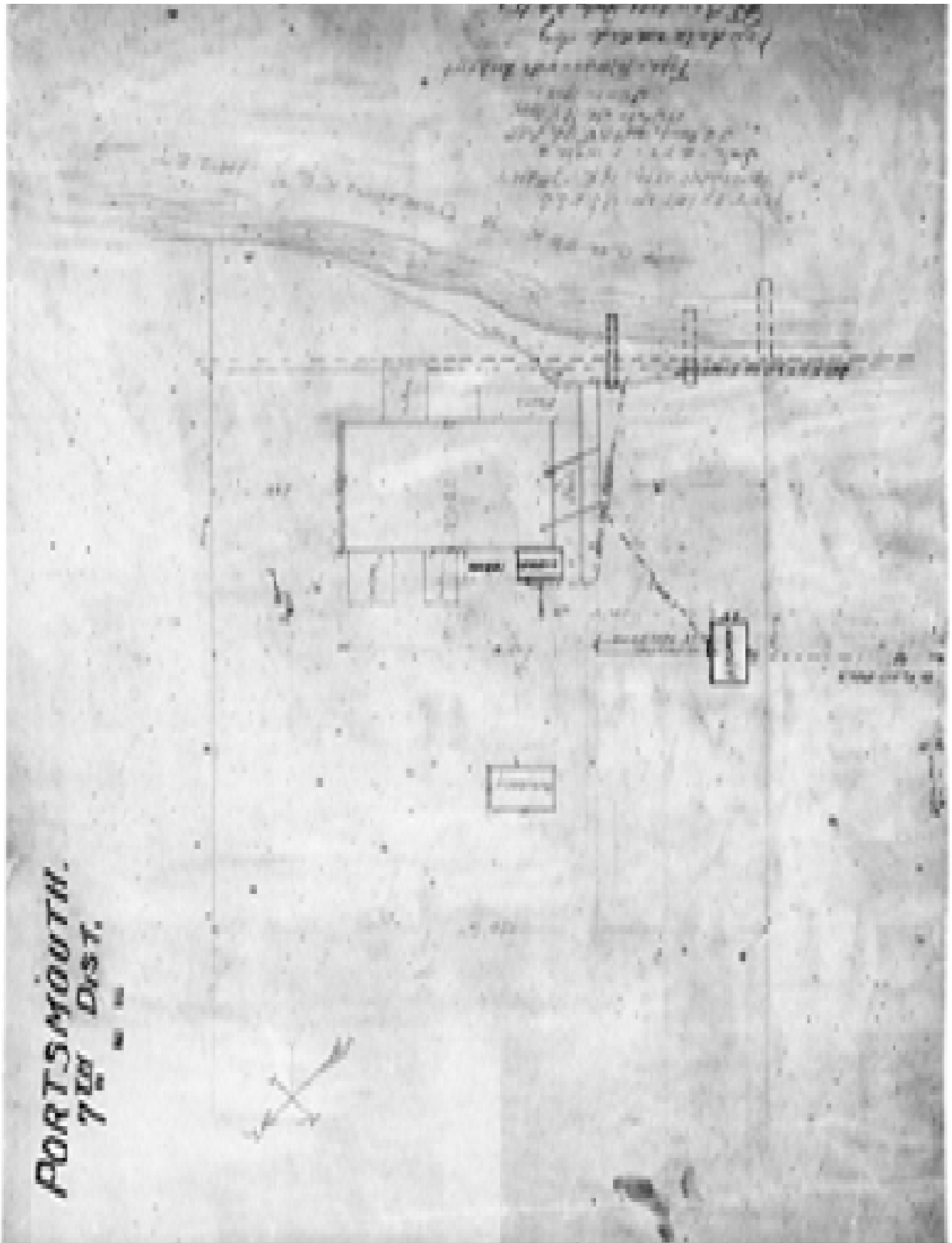

"Harbor and Proposed Location for Wharf," March 1913.

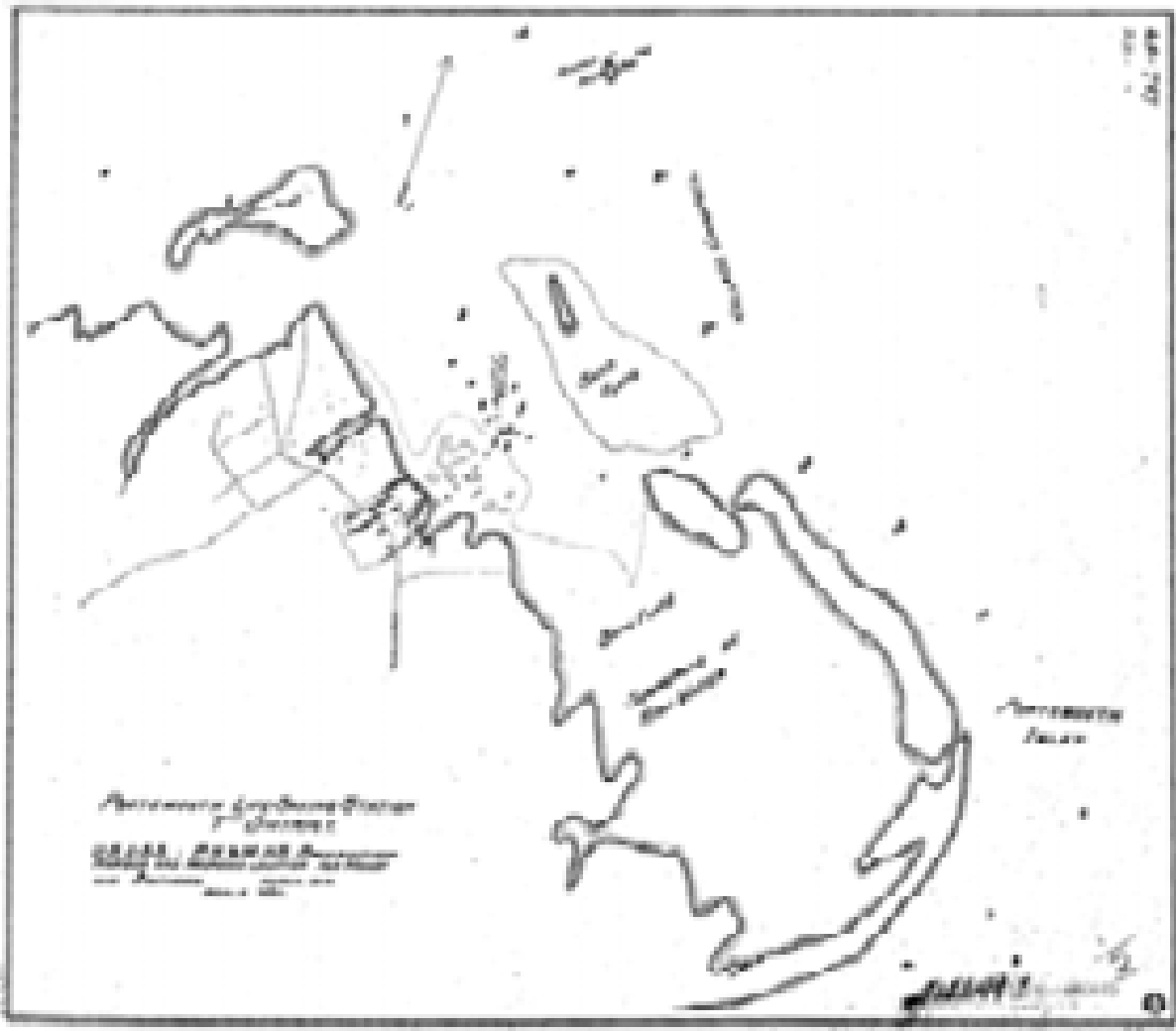

"Details of Walk and Wharf, and Profile Showing Ground and Wharf Elevations," April 1913.

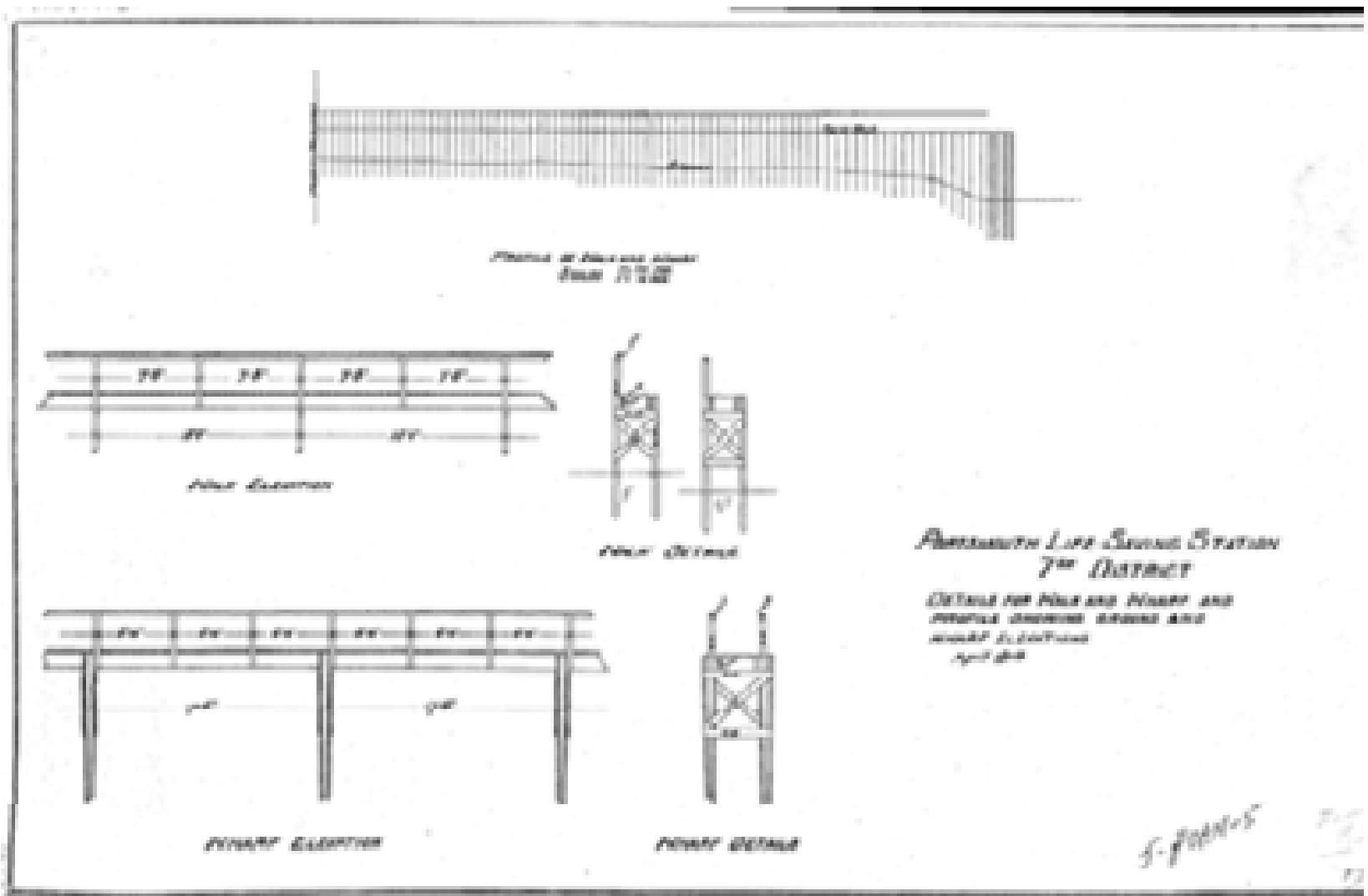

"End Section of Concrete Sheet Piles," July 9, 1914.

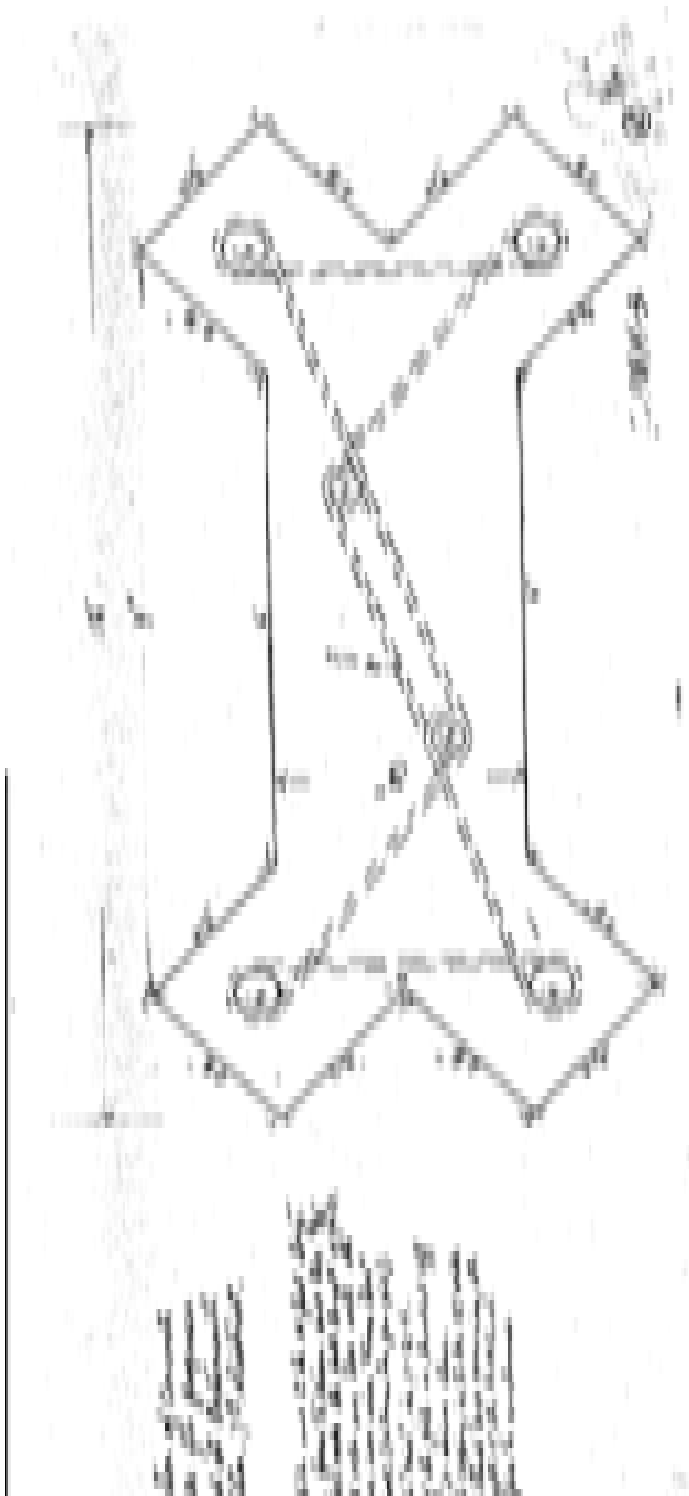

"Drawing of Walk," April 3, 1916.

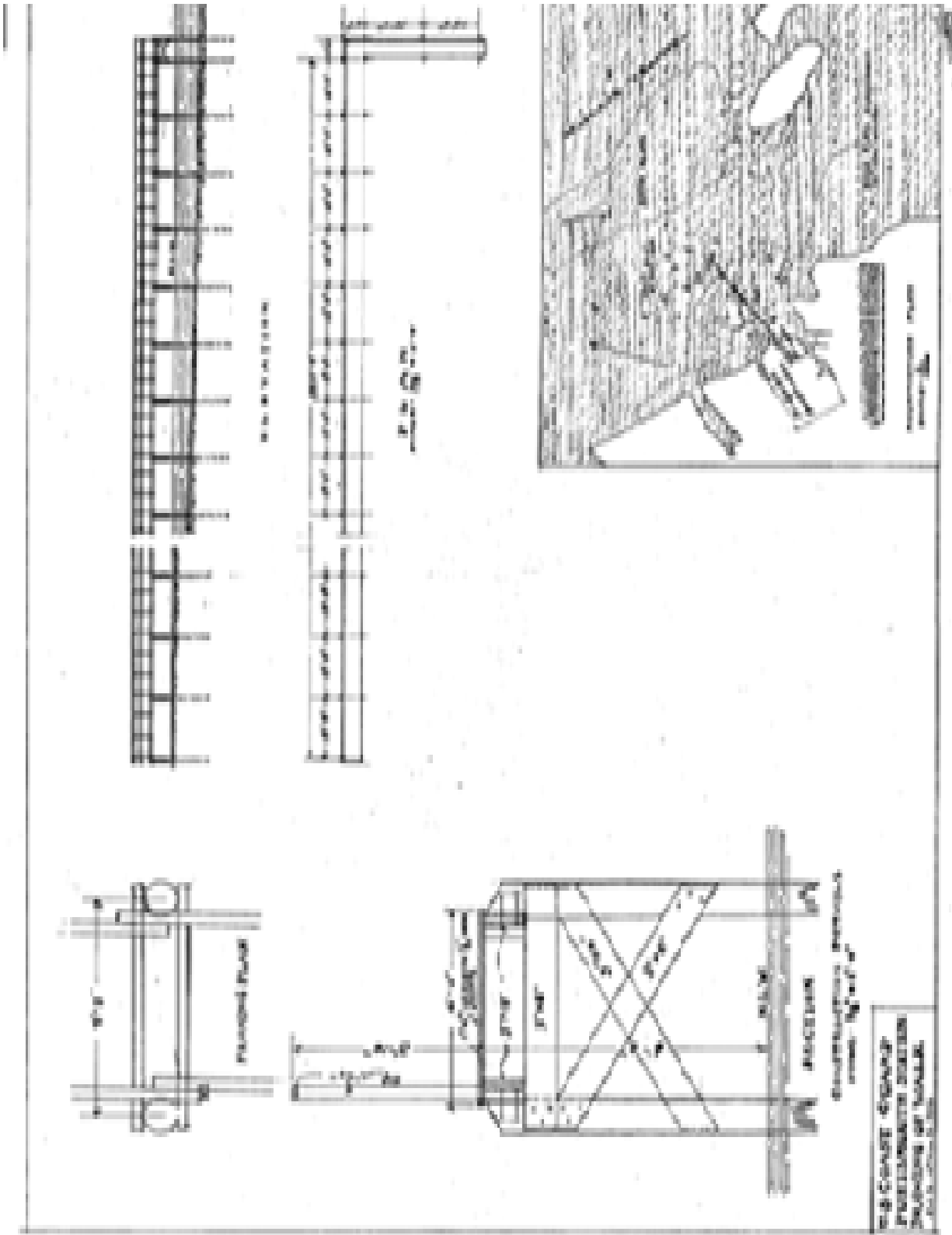

"Portsmouth Station" [plans of first and second floors], N. D., probably 1916.

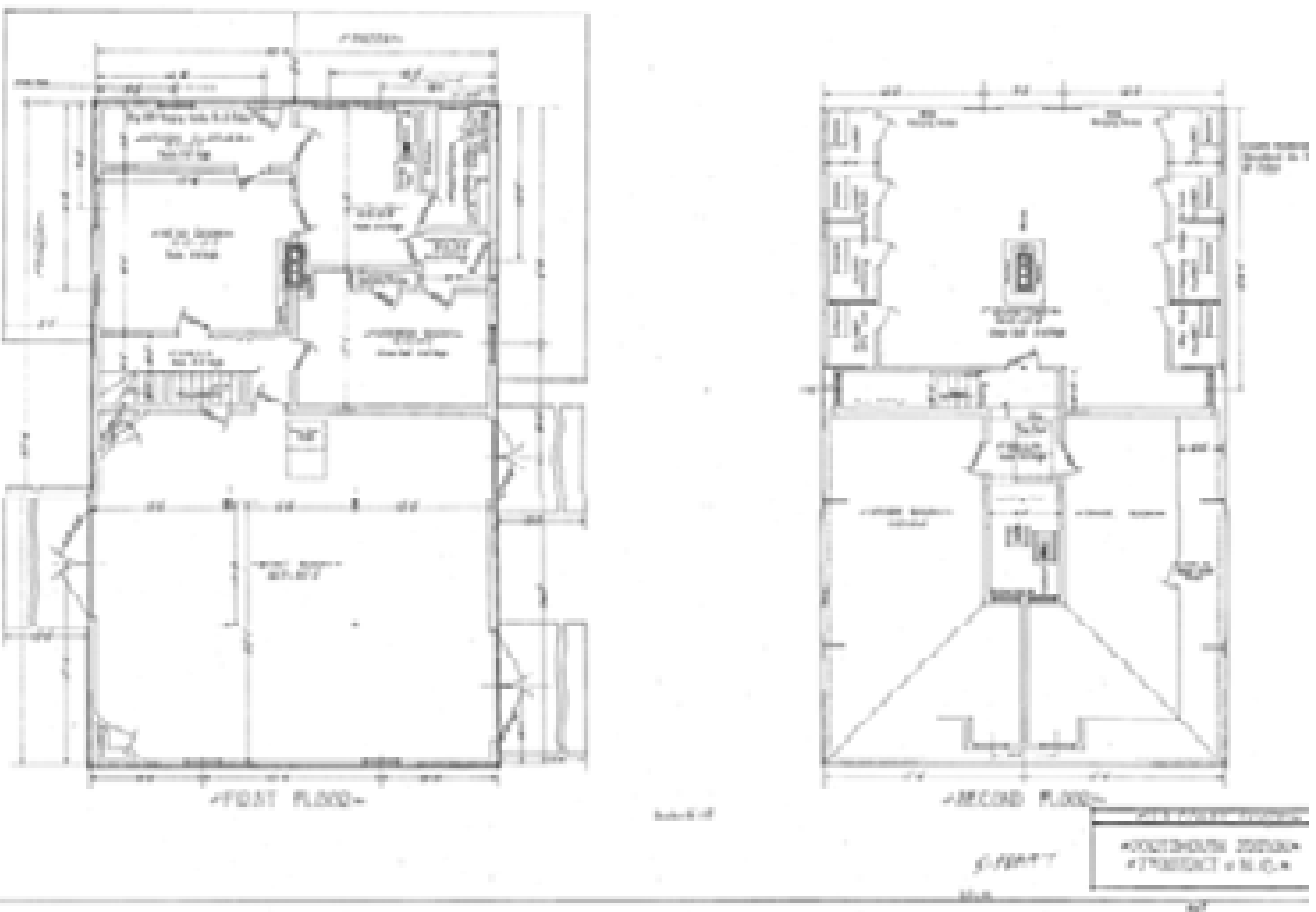

Appendix B

Specifications for Brant Rock Life- Saving Station

The specifications copied below were for the Brant Rock Life- Saving Station and were adapted for the Portsmouth Life- Saving Station per recommendations made in a letter from the Construction Superintendent, a copy of which can be found at the end of this appendix.



INFORMATION FOR BIDDERS.

All proposals to be made on blank forms, which will be furnished with the specifications and drawings. The individual names of a firm must be signed in full to the proposal.

Bidders to state the time they will require to complete the buildings ready for occupancy.

Certified check.—Each bid must be accompanied by a certified check in the sum of \$100, drawn in the order of the Secretary of the Treasury, as security that the bidder will enter into contract without delay and give such bonds as security for the faithful performance thereof as may be required if his bid be accepted. Certified checks will be returned within two weeks to the unsuccessful bidder, and the check of the successful bidder will be returned after his contract, together with bond for the faithful performance of the terms thereof, shall be approved by the Secretary of the Treasury.

Forfeiture.—At the discretion of the Secretary of the Treasury, on failure of the successful bidder to enter into contract, his check shall be forfeited to the United States Government. Proposals must be enclosed in a sealed envelope and labeled "Proposals for the construction of a life-saving station at Barnet Rock,

Mass.

The right is reserved by the United States Government to reject any or all bids or to waive defects.

SPECIFICATIONS.

GENERAL CONDITIONS.

The contractor is to provide, at his own expense, all the apparatus, materials, and labor, including transportation necessary for the complete and substantial execution of everything described, shown, or necessarily implied in the drawings and specifications.

He must give his personal superintendence to the work, keeping a constant presence upon the premises, and see that everything is constructed in the most workmanlike manner, according to the true intent and meaning of the drawings and these specifications, all of which are attached to the contract and form a part thereof.

QUALITY OF MATERIALS AND WORKMANSHIP.

All materials and workmanship throughout to be the best of their several kinds, unless otherwise specified.

The drawings and specifications are intended to correspond with each other, and anything shown upon one or stated in the other is to be done and performed as if set forth upon both. No advantage is to be taken by the contractor of any variance in the specifications or drawings, or full explanations and detail drawings will be given for any part of the work not sufficiently shown or understood.

All site working drawings will be supplied to the contractor on application to the Department of Construction of the working stations.

When figures are given on the drawings they will be the units, otherwise units dimensions to be accurately followed.

Any permanent matter of construction essential to make the necessary substantial and durable, but which may have been omitted from the specifications and drawings, shall be supplied and put in place by the contractor at his own expense.

The buildings to be erected under the supervision and to the entire satisfaction of such person or persons as may be designated by the Government, who are to have at all times access to the works. The contractor shall substitute, at his own expense and without delay, satisfactory work and materials for such as may be rejected, and make good all other work that may be disturbed thereby.

Any damage to the building during its construction, by fire, wind, or otherwise, must be made good by the contractor, who will also be responsible for any injury to person or property caused by his act or default.

The contractor will protect the work and materials from damage during the progress of operations, and will clear away from time to time, as may be necessary, all dirt and rubbish resulting from the work: on completion he will thoroughly clean all floors and windows, remove all rubbish, and leave the premises in good order, ready for occupancy and satisfactory in every respect to the superintending officers, to whom he will then deliver the keys. The contractor is to guarantee the roof to be tight and free from all defects for the space of one year after completion of the building. The sum of one hundred (100) dollars will be withheld by the Government, to be retained on account of the contract, to fully comply with this guarantee.

BRICKS AND EXCITATION.

Excite in the depth required by the drawings for benches to receive medals, chairs, chimney, and drains.

Excite in the depth required by the drawings for benches to receive medals, chairs, chimney, and drains.

Excite in the depth required by the drawings for benches to receive medals, chairs, chimney, and drains.

Excite in the depth required by the drawings for benches to receive medals, chairs, chimney, and drains.

MAKING WORK.

Time, cement, and sand.—All the lime used upon the work to be extra No. 1 Rockland. All the cement, unless otherwise specified, to be best fresh Rockland. All sand to be well washed, clean, not stony, and used in the proper proportions.

Bricks.—To be best hard common bricks, and all to be new, well shaped, and of uniform size.

All to be laid wet, except in freezing weather, with joints thoroughly finished up with mortar and all well pointed. All brick-work to be plastered is to have rough joints; other work to have the joints neatly struck.

All brick-work exposed to view to be washed down after completion with muriatic acid.

Chimney.—To be 8 by 8-inch frame with 4-inch staves attached to frame plastered inside, while chimney is being built, and smoothly struck. To be plastered outside up to roof boarding. Flue to be carried separate the full height. To be of heavy brick laid in common mortar, six (6) courses at base (7) of flue, as far as the underside of roof boarding; above that to be of selected brick laid in mortar of equal parts of cement and lime. The six (6) top courses to be laid in pure cement.

Top three courses cemented and struck to weather.

The "down-down" lead flashing to be built into chimney.

Flue caps.—To be weatherware chimney with rigid metal covers on the four openings, so arranged as to guard against fire. The flashing of chimney around to be cement and plastered directly upon the bricks at the openings.

Five steps.—At the level of the top of the under floor boards one course of bricks to project 1 inch on several chimney stacks at each story.

This projection to be high enough above floor boards to allow for the settlement of chimney stack.

The angle formed by the brick down-slop and top of under floor boards to be filled with joggie mortar, as shown upon drawings.

Concrete.—To be well seasoned aggregate, twenty (20) inches thick, made of good intermediate cement, clean sand, and broken stone, in proportion of one (1) cement, two (2) sand, to five (5) of stone.

Drains.—To be a size of four (4) inch, with ground, "A" brand weatherware pipe, leading from sink waste pipe; laid upon a uniform grade; bottom of trench hollowed to receive pipe; the joints all to be laid in clear Portland cement, and covered around bottom. Outside in the line of pipe a five (5) inch round iron pipe, of the same make, with hand hole. To be placed not less than six (6) feet from the house. Hand hole to be closed with a tight cover. The connections and discharge of pipe to be as directed by the superintendent.

LATH AND PLASTER.

Cover all the inside walls and ceilings, excepting base course, lockers, and bathroom space room, with lath and plaster, in best two (2) coat work with best sand finish. Plastering to be carried down to under floor in all cases.

Laths.—To be best seasoned pine or hemlock, free from knots, bark, or resin; an inch 1 inch apart, reaching joints every six (6) inches over doors and window heads.

Lime, hair, and sand.—The first coat of plaster to be two (2) parts Rockland lime and clean sharp sand, well mixed with half bucket of

best long nails or good nails to each end of line, thoroughly worked and shaked at least one week before using. In some shallow places.

All to be well rounded, straightened with a straight-edge and made perfectly true, and brought well up to ground.

The stims or mud mat to be No. 1 water. Buckboard stims shaked at least one week before using, and washed good, well hand-finished, and worked hard and smooth. The angles between plaster ceilings and walls to be filled concave, run in the plaster as shown upon the drawings.

Plaster Jobbing.—On first, second story, and between studs, on top of under lines, on line of outer walls with rough plaster to stop off joint cracks. Also around the steps, between the furring and faces of chimney at top of under lines.

FRAMING.

The frame is to be framed perfectly true and plumb, in accordance with the framing drawings.

No framework is to be placed within one (1) inch of the outside of the chimney, and no nails are to be driven into any chimney.

The framework is to be properly constructed by mortising, notching, lapping, banding, splicing, planing, and spiking all the parts together (except the shudding, which will not be tenoned), making the JOINTING as strong as possible thereby.

Leveling up with wooden strips will not be allowed.

Must use, steel nails, and planes to be of full length where practicable, but in no case more than two (2) equal lengths. All to be halved, lapped, pinned, or bolted together.

Corner posts.—To be red cedar or yellow pine, ten (10) inches in diameter, rough, square where here on the outside to receive the bracing.

These posts to be placed as shown on the drawings, braced by 4 by 6 inch braces at outer angles and intersections.

Iron straps.—Every corner post to be tied to the frame all by 4 by 4 inch iron straps running twelve (12) inches on the post and securely spiked on.

Wall studs.—To be best joints, well spiked in.

4 by 6 studs, etc.—To be square and not pinned.

Four inch—6 by 6 stud, to be shrouded under with red girths, and well spiked to studs and to one another where they lap, so as to make a strong tie across the building.

Second story posts or so "wind" are (11) inch upon partition walls, stumps and plate, to top and to strongly spiked together.

BRACING.—Floor joists to be braced, as shown on drawings, by X bracing, 1 1/2 by 2 inch stock, nailed with two (2) nails at each end.

Partition studs.—To be 2 by 4 inch, and 2 by 4 inch sleepings, placed double and framed above, as shown.

Roofing-lath bracing.—Partition studs to be spaced continuously by one (1) inch of bracing-roofs bracing over in height of each story. All angles to be made solid. Stud to be not twelve (12) inches on centers, or five (5) inches to a lath.

(c) **Partition caps and sills.**—To be 2 by 4 inches, of Georgia pine.

Fields.—Partitions over all doors to be securely framed and braced.

Double rafters.—To have a 2 by 4 inch collar let in between, 1 inch being cut out of collar and rafters each side, all securely spiked.

Common rafters.—To be securely spiked to ridge and plate.

On gable and the studs will run up to a 4 by 4 inch cap joist, as shown on drawing drawings, thus supporting the piece of a collar.

Roofing boarding.—The entire rafter and roof to be covered with tongued and grooved, dressed one side, planed to an even thickness, No. 2 pine or hemlock boards, of 1 1/2 inch stock, not exceeding eight (8) inches wide.

Shingles.—The entire outside walls, roof, and dormers to be covered with the best quality of shingles, white-oak shingles, laid six (6) inches to the rafters on walls and five (5) inches on roofs, random widths, secured with two (2) galvanized iron nails to each shingle. Where they butt against eadings, they are to be nailed on that side only, and with two (2) nails.

Full and standing paper.—Roofing boarding to be covered with one (1) thickness and roof boarding with two (2) thicknesses of H. F. Watson's (Type, No. 1) "W. C." waterproof sheathing paper, an entire thickness at all valleys.

Between upper and lower floors in first and second story and between 2d and 3d floors of H. F. Watson's (Type, No. 1) insulating roof boarding felt, laid top joint, with the edges turned up 1 1/2 inches under handboard as studs (as shown on drawings); to be carried up to top of sheathing on the inside wall of lookout.

Grounds.—To be 1 by 1 inch for plastering. Good furrings placed to receive same; working angle made at all outer angles to receive plastering.

Furrings.—Ceilings and incline of rafters to be furred with 1 by 1 inch strips placed five (5) spacings to a run.

Chilling of basements. to be furred to receive sheathing.

PLASTER.

The upper floor of first story and second story over bath room to be 2 inch stock, planed one side to an even thickness, grooved and spiked.

Windows not to exceed six (6) inches. Sillings to be Georgia pine, 1 by 11 inches. Upper floor in first second story, and balcony to be with Georgia pine, 1 inch thick, placed in an even thickness, jointed, hand-matched, stained, and laid close; window not to exceed three (3) inches. All upper floors to be placed off square and laid close on completion of the building. Under floor of balcony and platform to slope below to be 11-inch stock, placed in an even thickness.

END OF FIFTH

Detail and finished drawings will be furnished the contractor, as before mentioned.

Hand-matched.—Where not otherwise specified or shown, to be of best quality white-painted pine, free from all defects; to be hand-matched, square, etc., worked out with sandpaper. The pattern of moldings, the detail and full size drawings to be strictly followed. To be generally 1-inch stock.

Architraves.—Where there is a dado, to be 2 1/2 inches; elsewhere, 1 inch thick. Corner blocks, with a beveled cornice, and pilaster blocks to be of the same width and thickness as architraves.

Mould baseboard.—To be seven (7) inches high, including molding, measured from top of under floor. Where there is a dado there will be no baseboard.

Floor base.—Baseboard in spare room to be pine, with beveled top, six (6) inches high above under floor.

Dado and skirting.—To be white pine, 1-inch stock, placed in an even thickness, beveled and grooved, beaded, and not exceeding three (3) inch widths.

Dado top.—Beveled top to dado to finish back with architecture of doors and windows. The ceiling angles of skirting to be covered with a lead angle molding in head room.

CARP FILL.—To be 1 by 4 inches, milled as per detail, secured by a metal facing, back with plastering.

Windows and doors.—To be double hung, sitting-sash, partlets in sashes, evenly balanced with round bottom and iron weights, hung with best "Barnum" sash cord.

Folley sashes and sash heads of Georgia pine. Sash heads to be secured by brass round head covers not exceeding 1 foot in center.

Stationary and partition windows.—To be 11 inches thick. (See drawings.)

Door windows.—To be generally like other windows. To be secured up from the floor, finishing with a window and.

Inside architraves, 3 by 4 inch, rounded and colored; as shown on finish blocks.

Paint and varnishes will be alike in all work.

Window frames on side to be like others, except being wider and higher.

The portion of this window in "unfurnished room" to have a narrow seat tapered in and stop heads, but no other finish details. (See detail drawings for size, etc.)

Seat over door.—To be 11 inches thick, tapered, planed, and rebated to receive 1-inch tenon, tapered, diagonal chocking with a planed mending broken around angles on one side only.

Door frames to be milled.

Turns of all doors to stop back 1 inch from face. (See detail drawings for all doors.)

Outside doors.—To be 11 inches, solid core, pine veneered, set up with waterproof glass.

Six (6) beveled panels, each milled both sides. Georgia pine milled thresholds, 1 inch thick.

Storm door.—To be a well-braced battened storm door in outer rebate of keeper's and crew's extension. Downways full height of opening.

Interior doors.—To be 11 inch solid pine; six (6) beveled panels, each milled both sides. Closet and gallery doors to be 11 inches thick. Closet doors in "Quarters" to be beveled, paneled as shown, no moldings, 11 inches thick.

Transoms under.—Where it is marked at a door opening on plans, to be a transom with same thickness as door.

Flashings.—Valley and hips to be "shingled in" with 16-ounce zinc.

TOPS of all outside casings to all openings to be finished with four (4) pound lead, to run up under shingles 11 inches and turned over casing, securely nailed. Chimney flashings to be 16-ounce zinc "Dutch hip" flashing six (6) inches high at the lowest point and to run six (6) inches under shingles, capped with four (4) pound lead "iron down". The jolly to be built into chimney stack one (1) inch. Curved feet of back-out to be made tight in the best manner.

Roofing cement to be used where required.

Copper flashings.—Copper 16-ounce lining on ridges, turned over a wooden roll and lashed. (See detail drawing.)

Slates.—(See detail drawing.) To have three (3) 1 by 12 inch rough stringers and wood coverings.

Trunks, slates, roof mending, STRIPPER and gallery casings, wood-pole, and balusters to be Georgia pine; hand-rail of cherry. All to be

blocked, fitted, glued, and secured (using iron dogs and ties where necessary) in the best workmanlike manner.

Treads 12 inches with open nosing, boards returned on ends and beveled into riser as felt.

Risers 2-inch, tongued into underside of treads.

Knewel post 4-inch stock, turned to a pattern.

Endposts one (1) inch round, let in full diameter into treads.

The rail of 1 by 2 inch stock, milled.

The stair leads to admit onto stairs in best manner.

To be a 12-inch pine or oak post to receive handrail at head of stairs.

There will be a narrow well hole.

Lockset steps.—(See detail drawings.) To be of Georgia pine, dressed, squared angles slightly rounded, stringers, 2-inch stock. Treads, 12 inch stock, beveled into stringers. Open riser.

Lockset-step platform.—Platform floor to be 12-inch Georgia pine, jointed. Floor joint to platform and lockset will be exposed to view. To be mill-planed with edges slightly chamfered or rounded. The plastering to be carried up to under side of lockset floor and a molding run in the angle of walls only, and in between the joint.

Iron pipe handrail.—To be a one-inch iron pipe hand rail and platform rail, with iron-pipe standards, all properly connected and strongly secured.

Outside steps.—To have three (3) steel 2-inch stock, mill-planed pine stringers, with 12-inch Georgia pine treads, open riser, all well secured to house.

Platform and steps.—Platform and steps to keeper's entrance to be strongly framed, squared timber, mill-planed, resting on cedar or locust posts, and a sill. Floor 12 inch Georgia pine laid open joint to pluck 2 inch away from building.

Paired platforms.—Three (3) cedar posts 12 inches in diameter are to be set where directed, four (4) feet into ground, and well pointed or rounded. To be tapered into 6 by 8 inch sill pieces to support front or ground end of each platform. Stringers to be 2 by 4 inches, placed 12 inches on centers, strongly secured to house sill and ground, all at front end.

Floor to be 2-inch planed spruce, laid 12 inch open joints, not exceeding six (6) inches wide.

Gradient.—The gradient of the platform will be determined by the superintendent, and under his direction to be so arranged as to give an easy run to the boats and opposite wharves.

Trap-door to lockout door.—To be 14 by 8 inch dressed frame, cross braced, resting on a rebated, 14-inch casing piece, all around, to be covered the same as, and to finish flush with, the lockout door. The edge piece of the upper door to be mitered around trap opening.

Trap-door to passage over heat room.—To be in two (2) leaves, of 14 by 4 inch dressed frame, cross braced, resting on a rebated, 14-inch casing piece, all around, to be covered the same as, and to finish flush with, the top of masonry shaft door. Edge piece mitered around trap opening.

Skirting.—To be ten (10) inches wide, unless otherwise specified, dressed both sides, and where not supported by standards or ledges to have 8 by 10 inch horizontal brackets of approved pattern, not over three (3) feet on centers.

Staircase.—To be strongly jointed and neatly set up. All to have hard wood runner strips.

Passy.—To have a counter shelf two (2) feet wide and three (3) feet high, with exposed sides, or narrow tongue-and-grooved beaded skirting, 4-inch by counter door and wood handle, with casing down below and filling like above. Exposed faces of shelves to be neatly beaded.

Cover door.—To be eight (8) feet high, four (4) feet wide. The lower part to be three (3) feet high, with counter shelf two (2) feet wide. To have three (3) wide drawers and a side division with open shelves. The upper part to be 4 feet deep, with three (3) shelves enclosed by two (2) swinging, glazed doors. (See drawing.)

Entrance chest.—To have four (4) shelves and three (3) drawers, with counter shelf placed, as directed, under stairs.

Two (2) chests in entrance of heat room to have three (3) shelves each, in drawers.

Upper glass.—To have a shelf, as shown.

Shelf in passage.—To have two (2) drawers, stand two (2) feet high with counter shelf three (3) feet long, twenty (20) inches wide.

Partitions between.—To be 4-inch tongue-and-grooved skirting, with a grooved base and side piece.

Shelf.—To be a "Columbian" wrought steel galvanized sink, 14 by 18 by 4 inches, of W. & B. Douglas' make, Fig. 333, with a brass sewer drain, complete, supported by a strong frame, left open below, with a wooden grooved skirting shelf, as shown. All to be set open below and neatly finished.

Waste pipe.—To be properly connected with drain pipe by a 14-inch lead pipe.

PUMP—To be a Direct Drivley Hand Fireman Pump, No. 1, No. 2, of W. & B. Dwyer's make (Middletown, Conn.). To have a 2½-inch bore, 4-inch stroke, and 1½-inch galvanized iron suction pipe, iron couplings, brass thread case, all properly connected with cylinder.

Slipping straps—To be eight (8) running feet of 4 by 4 inch headed strips placed where shown upon the plans or as may be directed.

Beams—To be 1½ inches thick, eight (8) inches wide, eight headed, supported by 1 by 2 inch bronzed iron ornamental brackets of approved pattern.

The railing in rear room is to consist of 1½ inch iron slides, as shown on plans.

Wood valves—To be put up near sink.

WATER AND CONDENSERS.

Gutters to be V-shaped, tongue, hand-smoothed white pine, jointed with white lead, connected by proper lead goose necks, with four (4) inch corrugated, galvanized-iron conductors. The latter properly connected with cistern. The gutters to be so arranged as to receive the rain water from the white roof. No gutters to lock-out roof.

FLAGSTAFF.

The flagstaff to be in two parts; lower mast with cross-tree and topmast.

The lower mast to be of white pine, 48 feet long, 12 inches diameter at heel and 7 inches at head; topmast of spruce, to be 20 feet long, 4 inches diameter at heel and 2½ inches at head.

A 4-inch liguan vine truck, two sheaves and halyards, wooden cleat on lower mast for climbing to mainmast, and iron cleat for braying halyards to be furnished.

The lower mast to have 4 feet stepped and marled into 4 by 12 inch masts, 12 feet long, crossing each other at right angles.

The lower and butt of staff to receive a thorough coating of oil and tar.

From the side of masts 4 by 4 inch braces will extend to the lower mast above the section of the joint, and be properly braced, ho and secured.

The flagstaff to be erected and fitted up ready for use of signals.

PAINT AND GLAZING.

All woodwork for painting and glazing to be prepared by properly rubbing down, priming up, etc.; all knots properly killed with shells;

nails set, and work siled before putting up. All inside woodwork, not otherwise specified, to have one coat of light wood stain, made of stains and pure linseed oil, and finished with two (2) coats of "Pol-lacoidin." Hard wood floors and thresholds throughout to have two (2) coats hard oil finish. Stairs to be siled and finished with one coat of Pol-lacoidin. Handrail siled and rubbed down only. Inside of window sashes to be stained cherry before receiving finish coats. Hard wood steps siled, two (2) coats, and finished with Pol-lacoidin. Hard wood porch siles siled, two coats. Outside of window sashes to be painted dark red, three (3) coats. All outside woodwork usually painted to have three (3) coats, light red, made of Venetian red and yellow ochre and pure linseed oil. Outside work to be primed directly it is put in place to prevent warping and checking. Outside of bathroom doors to be oil stained and finished with three (3) coats of Pol-lacoidin. Finishing of platform to be siled, one heavy coat. Staircase painted. Sillings to be left in natural wood, no paint or oil. Copper flashing not painted. Shelving, drawers, and china cabinet in pantry painted a light drab tint. Plaster to be painted white, but three (3) coat work.

All paint work to be of the best materials, with a mixed white lead and French zinc base, using a large proportion of oil and the smallest practicable portion of spirit or dryer. Only pure linseed oil to be used.

Excepting the windows and doors, there will be no paint work in hall, un-finished spare room, or floors of closets. All hollow iron not galvanized to have two (2) coats red lead and oil, one before and one after being set.

Glass all inside and outside sashes, unless otherwise specified, by second quality double-thick American glass in lights as shown on the drawings or as may be directed.

All well bolted, primed, back-primed, and tacked.

All at all repairs at the completion of the building, thoroughly cleaned and left white and primed.

The glass in lookout windows to be best quality, selected, double thick, American glass.

MISCELLANEOUS

Siding below water table to be 1-inch dressed, selected pine, carried below grade level at least one (1) stick.

Wood wood posts.—Wood posts in front room to be pine turned, eight (8) inches at butt to taper to seven (7) inches at the top, bored the entire length with a 1 1/2-inch hole, and a 1-inch ventilating hole bored into this near the top of each post.

Posts to be trenched into a hard-wood cap piece at top seven (7) inches wide, one (1) foot six (6) inches long, notched on their ends, as shown, and secured to girders above by 1-inch galvanized-iron bolts, nuts, and washers.

Posts to frame into girder at both ends.

Flap table.—To be in sections, laid up of narrow pieces dovetailed together and glued, or be of solid wood, but long across.

Flap upper doors.—Upper doors of closets in Keegan's room, Dress-room, Quarters, and unfinished space room to be of pine, spruce, or hemlock of 1 inch, planed one side to an even thickness, jointed, dove-tailed, lined inside.

Weather strips.—To be painted rubber weather strips to the two small outside doors.

Outside finishing.—Finish with zinc turn-ups and lead turn-downs at junction of siders with lower in best manner.

HARDWARE.

Bed room doors.—To have stout galvanized wrought-iron strap hinges, loose joints, and steel or bronze washers, all to be of an approved pattern.

To be secured to the door with proper carriage bolts, nuts, and washers.

Each leaf to have stout galvanized wrought-iron pull handles, both sides, inserted by through bolts and nuts.

To have heavy top and bottom brass slide bolts to each door, or six (6) in all.

There will be no locks. Doors to be secured shut by stout hard-wood mauls, bars with stout galvanized wrought-iron sockets.

Doors to be secured open by stout galvanized iron tag wire eyebolts, hooks, and wooden posts. The latter notched on and strongly bolted to s-t-raps of platform.

Bars.—All doors, not otherwise specified, to have brass-joint, steel-washer, Boston-finish, 4 by 4 inch bolts. Through (3) to each outside door.

Door knobs.—All doors, not otherwise specified, to have 12-inch cherry-wood polished door knobs, No. 100, Yale and Town Manufacturing Co. make, with wooden shaft, rose, and threaded spindle.

Cherry key plates, No. 11.

Cherry, hard turned and polished, turn, door stops with hard-wood bar centers, No. 100.

Keys to street doors 1 1/2 inches diameter; steel make.

Pantry door to have knobs lock sides.

Upper and crew's entrance doors.—To have each a "Standard" lock lock, with handles, No. 1000, and Yale also night latch, No. 10, complete.

Crew's door to have eight (8) keys.

THE TWO LOCKS NOT INTERCHANGEABLE.

To be done (4) hours from (4) lock issued below with necessary completely lock in the station on completion of the building.

Storm doors.—Two (2) storm, outside, doors to have plain japanned-iron handles and lock latches, complete, with galvanized-iron lag screw SYSTEM, AND LOCKS TO MATCH THEM, OPEN AND SHUT.

The following doors to have "Standard" key spring, mortise lock latches, No. 1000, Yale and Towne Manufacturing Company, with two (2) keys each: Two (2) doors in keeper's room, two (2) doors in kitchen, two (2) doors in main room, one (1) door in second story.

THE FOLLOWING DOORS TO HAVE "STANDARD" KEY SPRING, MORTISE LOCK LATCHES, No. 1000, Yale and Towne Manufacturing Company, with two (2) keys each (EXCLUDING CREW'S ROOMS): One (1) door in pantry, one (1) door in keeper's room, one (1) door between boat room and hall, three (3) boat-room closed doors, two (2) doors in second story (space rooms), eight (8) doors in crew's stowage (two (2) key each).

All doors to have brass joliet, steel washers, Boston finish, 4 by 4 inch beams, of seasoned main.

Door to lock to have plain japanned-iron lock latch and handle, complete, and steel loose joint, Boston finish bolts. No door stops, or bars.

Window hardware.—To have Yale and Towne Manufacturing Company make, No. 1201 P., real bronze, natural color with rollers, complete, and best "Roman" beaded window sash.

Sash fasteners.—To have real bronze, Yale and Towne Manufacturing Company make, No. 1202 P., self locking with fasteners, complete.

Sash lifts.—Plain, real bronze, No. 1201 P., lock with lifts, complete. Two (2) to each window.

Chief sash hardware.—To have "Yale and Towne," No. 1001 P., plain bronze exposed ends; brass bolts AND SCREWS. THIS DEVICE LOWER PULL, COMPLETE, ONE (1) TO EACH WINDOW.

Brass bolts and screws to lock lifts and exposed ends, and lower, plain exposed catches to exposed doors of the barrel divisions.

Downer pulls elsewhere to be plain brassed iron, two (2) to each crew.

Swing windows and transoms.—Brass bolts and screws to swinging windows and transoms, and hinged into, patent, lever arms, to work from below, to hold them open and close.

Trap sets.—In kitchen to have 4 brass bolts and screws, complete.

Trap doors.—To have stout strap hinges, flush, two (2) to each lead lockout, and three (3) to each lead second story floor trap, with flush ring pulls. Hooks and lag screw eyebolts to hold them open.

All the above trap iron work to be galvanized.

Staircase hooks and hanging hooks.—The contractor is to provide three (3) dozen six (6) inch barrow hooks, and seven and one-half (7½) dozen black japanned hanging hooks, of an approved pattern, all with brass nuts, complete, and leave them in the building on the completion of the same.

CONCRETEWORK.

TO FORMS WHEN AND HOW BUILT, ALL STAIRS, AND POLES:

Foundations to be eight (8) inch red cedar posts, set four (4) feet into ground and about five (5) feet on centers.

Frames to be of the same quality, material, and workmanship as the main house.

Posts to be 6 by 6 inches; posts, 4 by 4 inches; plates, 2 by 4 inches; studs, 2 by 4 inches.

Truss joists, 3 by 10 inches, sixteen (16) inches on centers.

Railers, 3 by 8 inches, two (2) feet on centers.

Collars, 3 by 6 inches on every other railer.

Floor of two (2) inch spruce, planed one side, jointed, and spiked.

The parties not included in wood and coal bins to have a Chicago pine, dressed one side 1 inch thick, jointed, blind-nailed, narrow width floor.

To be one thickness of Watson's insulating felt between floors.

Upper floor of coal and wood bins to be 1½ inch rough boards, jointed, and dressed one side.

Outer walls and roof covered with tarpaulin and gravel, tilted one side to equal thickness, 1½ inch pine, hemlock, or spruce boards, covered one (1) thickness on walls and two (2) on roofs, with Watson's "W. C." waterproof sheathing paper properly tinned and tacked.

Walls and roof to be shingled like main house, and finish of doors and windows generally the same, except leads to be plain.

A heavy 3-inch rough plank division to separate the bins, with movable sections on front passage and boxed shovel hole. Interior of coal and wood bins to be sheathed six (6) feet in height with two (2) inch rough pine, spruce, or hemlock planks, jointed and spiked.

The other partition shown to be finished on the side only, against
pry, up to plate with standard L-track tapered and grooved, headed
anchoring narrow width.

In party to be six (6) feet high all around inside.

Ceilings throughout to be left open.

WINDOWS to have selected glass frames and sills. Frames 12 inches,
to casing extended. Hang with brass, to be lag screw eye-bolts and
hooks to secure them open and shut. Plate casing inside, outside the
main frame.

Openings in rear wall of main to be closed by a strongly-hatted
sliding, made of narrow, matched, and headed white pine, opening
outward, hang like windows.

Door to be framed and placed, selected and painted with 1-inch
tongued and grooved diagonal boarding, secured to with brass screws.
All DOOR, lag screw eye-bolts and hooks to be galvanized.

Door opens to left.

Door to have brass black polished iron handle and 1/2 inch, 100

Take rim sight lock, No. 44, complete.

Flush about openings same as main house.

Roofs to be covered same as main house, with 18 gauge copper
board over wooden sill.

Oil room to have two (2) rows of shales for (10) inches wide.

Privy and closet to be 12-inch clear white pine with proper fits.

A strong BOX OF painted concrete to be made, as directed, in standard
form. It must be easily removable, and be attached to the outside by
a hinged shutter.

A ventilator of plain boards to be made as shown.

A substantial plate work, three (3) feet wide to be held from stage
at 1/2 inch's clearance to door of rebuilding.

Outside woodwork to be painted in the same flat and manner as
main house.

CURTAIN.

A brick stove to be built adjacent to the kitchen, outside of the
main building, with a partition wall across the middle, with an open-
ing under, 4 feet of the height to be below the established grade, and
the remainder above the same; all dimensions and manner of con-
struction strictly in accordance with plans.

The stove to be built on well-cured concrete 4 inches thick, made
of good hydraulic cement, clean sand, and broken stone, in the pro-
portion of 1 cement to 7 sand to 3 stone.

The outer walls to be laid with a 2-inch space left in the middle and to be properly bonded across the same; this space to be filled with good made of best Portland cement mixed with water-lime sand, in the proportion of 1 to 1. The face to be one thickness of brick, edges being laid dry, with open joints 1 inch each; the open joints to be filled with good, the same as just described for the 2-inch space in outer walls.

The corners to be built with best hard-burnt brick and Roman-cement mortar; the brickwork to be well bonded and laid with joints not exceeding 1 inch in thickness. The bricks to be soaked in water before laying; the outer faces of joints to be struck smooth.

The inside of cistern except partition wall to require three coats of Portland-cement mortar, the last coat being of cement only. In the work on the cistern some hot fresh water and washed sand to be used.

Outlets for the down-spouts, pump-connections, and overflow to be left in the brick walls. The overflow-pipe to be a 4-inch cast-iron pipe, with elbows, from the cistern to 2 feet into the ground, where it is to be properly connected with the main house drain and carried to a point indicated by the superintending officer. The cast-iron pipe to be well coated with tar inside and outside. The walls of the cistern to be covered by a 2 by 2 inch plate, upon which a strongly framed and beamed lid of white pine in two sections will be secured by heavy galvanized-iron strap-hinges. To be a process built dome-tile, removable, built inside cistern.

A D D E N D A

The lot to be graded for a distance of twenty (20) feet around the building, the site now being fairly level. Where not otherwise specified the frame to be of spruce.

March 30th, 1896.

General Superintendent
Life-Saving Service
Washington, D. C.

Sir:

Referring to the plans and specifications for Life Saving stations of the
or Portsmouth style, you are respectfully informed that experience
has shown that certain alterations in them are desirable, and the following
is submitted for your consideration.

1st - Page 4 - "Roofing Work"

"No. 1 Rockland lime" is called for. Add "or equally good". For the reason that
it is difficult to obtain Rockland lime in all localities, and first quality
lime will answer as well.

2nd Page 9 - Shingles

"Shaved White Cedar Shingles" are called for. Change to "Shaved Shingles of
CEDAR, CYPRESS, or PINE" for the reason, first, that shaved shingles are no
better than unshaved shingles and are harder to obtain except in the New England
states, and, second, that while pine or cedar shingles are good in all
latitudes, they are no better than cypress shingles for use in the South.

3rd - Page 9 - "Floor"

Strike out the words "2 inch stock", and insert instead "two inches thick,
of such material as is used for similar purposes at or near where the station
is to be built" for the reason that the material is not now specified.

4th - Page 10 - Lines 3 and 4.

Strike out the words "jointed, blind nailed, strained and close."
and insert the words "matched, strained and blind nailed," for the reason
that as good a floor and a better finish can be obtained thereby.

5th - Page 10 - "Inside finish"

In the fourth line between the words "well dried" and "plac" insert the word
"white," for the reason that with the present wording other pine may be con-
sidered, which is not desirable.

6th - Page 11 (and sheet 8, drawings)

The construction of the boat room doors as called for and shown, is not as
satisfactory as it should be shown, in such doors, leakage and damage occurs
by the settling of water in the heads of the doors, where it sets
on the frame, and this in time causes discoloration and decay. Change the
class to the following. "The great doors of the boat room are to be carefully
made, as shown in details, of 3" x 4" well braced frames, dressed, beaded, and

strongly pinned together, covered on the outer side with $\frac{3}{8}$ " stock dressed on both sides, well matched and beaded, in width not to exceed $\frac{1}{4}$ " inches, set on vertically, and properly billed across to the frame, with edges rounded off. The outer covering to be further fastened with steel nails put in as shown, all to closely follow details."

Such doors are to be found in the plans for the L. S. Station.

7th - Page 14 - "Flashings" - line 3

Strike out the figures "12" and insert the figure "4" instead, for the reason that $\frac{1}{2}$ " flashings have been found insufficient to prevent leakage.

8th - Page 14 - "Hardware," "Best Best Door,"

2nd line. Strike out the words "all to be of an approved pattern" and insert instead, the words "two hinges to each door leaf all as shown in details"

for the reason that in the absence of such details misunderstanding and delay are apt to occur and it is desirable that in so important a matter as these heavy hinges there shall be no room for any misapprehension as to what will be approved.

It is suggested that drawings in detail of a hinge of about the following dimensions be made at your office and printed in the plans for these stations.

A hinge of $\frac{3}{8}$ " iron, $3\frac{1}{2}$ " long $3\frac{1}{2}$ " wide at the pin, reducing to 1" wide at the end. The pin to be $\frac{3}{4}$ " in diameter and its support at the door post to be of $\frac{3}{8}$ " iron, T shaped, with proper holes for bolt and screw.

The hinges to be straight, and plain in finish.

9th - Page 14, "Hardware," lines 7 and 8

Strike out three lines and insert instead "To have heavy galvanized iron slide bolts, two to each door leaf. These bolts will be furnished by the Government, the contractor will put them on the doors.

10 th - Page 14 "Hardware" lines 10-11:

Strike them out for the reason that the bars referred to will be unnecessary when the bolts above referred to are provided.

11th Line start 1:

The doorway for the hatch apparatus part is shown but 6' wide, while the parts are over 6' wide. This door should be shown 7' wide on the plans.

12th Line start # 1:

The opening and slide in the partition between the dining room and kitchen are of no practical use. A door, instead, will be much better and prevent the necessity of passing through the vestibule when going from one of these rooms to the other, which tend, to keep the dining room cold. With a door as suggested the heat from the kitchen will suffice for warming the dining room except in very cold weather.

If the above changes meet with your approval it is recommended that the specifications and plans attached be altered as suggested.

Appendix C

Portsmouth, NC, Life-Saving Station Log Books, 1894-1938

Notes taken from original volumes at NARA,
Record Group 26.4, Morrow, Georgia, Fall 2005

1894

- Sep 30 Sunday morning about 9AM A. Styron sighted boat 15 miles out; loaded with cedar and honey from Cuba; landed north of Ocracoke and went to Hatteras to telegraph
- Oct 27 schooner ashore on Beacon Island inside Ocracoke Inlet
- Nov 3 first full entries in log book made this day; crew listed include George R. Willis, Jesse Newton, Washington Roberts, Augustus D. Mason, James to Salter, George R. Willis, George W. Gilgo; Dennis Mason was sick
- Nov 12 patrols not taken, beach flooded; "tide all around station" with nor'easter blowing
- Nov 14 rcd uniforms for surfmen; "house duty performed"
- Dec 15 "scrubbed the house"
- Dec 27 vessel grounded at Ocracoke; Ocracoke Station unaware; vessell crew' small boat capsized but five crew rescued by people on beach joining hands and wading out into the surf; Terrell couldn't get men to go with him in vessel's small boat to get remaining three crew but they wouldn't go; "kept watch on beach all night. Also fires to encourage sailors."
- Dec 28 at daylight, Ocracoke keeper went to

work; saved two of crew with breech's buoy; one perished."

- Dec 31 3- masted schooner in distress; beach "all covered with water and ice"; 20 Portsmouth men helped launch Jersey boat

1895

- Jan 2 beach still flooded- - - had to take wagon apart and put in boat to get it back to station
- Jan 13 ship aground, lost anchor, could not get her off
- Jan 14 unloaded wood and flour but still couldn't get her off until wind changed
- Jan 16 rcd. "remainder of articles for Portsmouth Station"
- Jan 17 schooner Sulphen got off and went in to Ocracoke
- Feb 1 rcd. Jersey surf- boat and one monomay surfboat with sails- - - returned surfboat and wagon borrowed from Creed's Hill Station
- Feb 8 9 men from Davis oystering came to station; "there being so much ice was afraid when iit broke up they would be carried to sea. They was furnished meals and lodging."
- Feb 9 9 men still there; "everything froze up"; in 20s all day
- Feb 11 men still there; "dare not stay aboard their boats"
- Feb 15 men tried to get boats but failed
- Feb 17 9 men left station
- Feb 24 report on oystermen- - - stayed 9 nights and "furnished 162 meals at the Keeper's house."
- Mar 11 "Crew arrived at station at 7 AM and signed articles and went to work"; set key posts.

	Crew:		station
	1. Joseph W. Roberson	Mar 31	rcd. 1 sheet of zinc, 3 elbows, 6"
	2. George Dixon		galvanized stove pipe
	3. Augustus Mason	Aug 12	finished stables today
	4. Joseph Styron	Sep 4	rcd two cords of fire wood
	5. George R. Willis	Oct 6	fcd 4500 lbs oats, 4500 lbs corn, 8000 lbs hay, 1200 lbs straw
	6. Dennis Mason		
	7. Washington Roberts	Oct 10	tide knee deep around station- - - [Cat 2 storm stayed well off shore]
Mar 12	put up wreck pole		
Apr 6	discharged Joseph W. Robinson, George Dixon, Joseph Styron as directed by Gen'l Superintendent; hired Martin Dixon, George Gilgo, David Salter	Oct 11	oil and coal house tore up- - - breakwater east of station washed down along with part of fence
Apr 12	rcd box of clothing from Women's National Relief Assoc.	Oct 12	island still covered with water
Apr 17	tide all over beach and around station	Oct 29	crew repair breakwater
Apr 19	had to move north key post; shore washed away	Dec 2	tide around station, island underwater
Apr 18- 20	helping sweep for lost anchor to schooner lade with 500 tons coal		
	Crew:	1897	
	1. Jesse Newton	Feb 10, 13,	
	2. George W. Gilgo	17- 18	crew building boat house on outer beach
	3. Augustus D. Mason	Feb 26	finished boat house
	4. James T. Salter	Oct 30	warning rcd. about ships with yellow fever
	5. George R. Willis		
	6. Dennis Mason	1898	
	7. Washington Roberts	Mar 7	repaired walk from station to oil house
Aug 1	Crew arrived back at station- - -	Apr 12	island under water
	1. Dennis Mason	May 27	whitewashed barn and boat house
	2. Wash Roberts	Nov 1	rcd one grey horse
	3. Augustus D. Mason	1899	
	4. James to Salter	Apr 17	whitewashed fence
	5. George R. Willis	Aug 8	[San Ciriaco hurricane devastates Puerto Rico, Cat 4 storm at its height; still Cat 3, 110- 130 mph winds when it hit Hatteras]
	6. George W. Gilgo	Aug 16	gale, island under water, fence down, boat house at hill settled in sand
	7. Jesse J. Newton	Aug 17	9" of water in station; "stables gone with horses in them"; rescued families of Charles and Daniel Willis whose houses were off foundations
Oct 2	"Mrs. Ackins a lady boarding at Portsmouth was taking with cramps scent to Station for JJamaica ginger, could get none on the island, so keeper let her have some"	Aug 18	Willis families still at station
Oct 7	12 tons of coal for station	Aug 20	water still 3' deep between station and outer beach
Oct 19	rcd. two handcarts from Racine Wagon and Carriage Co	Aug 24	body found and buried
Dec 13	highest tide in 3 years	Oct 30	tide all around station; breakwater damaged; [Cat 2 storm came ashore south of Wilmington]
1896		Nov 23	rcd gutters, lumber for cart house and walk; additional material on Dec 22
Jan 16	Rcd. from Trent Lumber Co. by Schooner Two Friends lumber for breakwater- - - 20 pcs 2 x 12 x 16, 10 pcs 6 x 6x 16	1900	
Feb 3	crew finish building breakwater east of	Feb	asst super of construction framing watch

	house		
Mar 1	gale, sea tide over breakwater washed down in October; cut bank within 9' of station		1. Washington Roberts 2. H. D. Goodwin 3. M. M. Pigott 4. E. T. Roberts 5. H. S. Goodwin 6. Homer Harris 7. Milton Robinson
March 15-16	surfmen finish working on carriage house		8. Crawford Range
Jun 2	fixing boat room door		
Jun 14-17	tinner puts up new gutters	Jan 4	rd. Crawford Range
		Jan 7	nor'easter, sea tide washed sand down in the creek on east side of station 35' northeast of launch way for surfboat
1901			
Crew in 1901:		Apr 24	crew moved condemned boat house from beach to the station to shelter the Monomay surfboat
	1. Wash Roberts	Apr 26-29	crew work on boat house
	2. W. T. Willis (b. 1870)- - Portsmouth	May 1-2	crew whitewash boat house
	3. D. W. Yeomans (b. 1873)- - Portsmouth	May 22	"crew engaged putting hard oil finish in keeper's and dining rooms"
	4. M. M. Pigott	May 23	finished hard oil downstairs
	5. J. W. Fulcher	May 27	putting rocks and turf at south corner of station
	6. H. D. Goodwin (b. 1873) Portsmouth	Sep 23	rd. new Lyle gun w/ carriage, etc.
1902			
Nov 28	rd. two wood heating stoves		
May 23	men putting windows and painting "trimmings"		
1903		1906	
Dec 22	a piece of plastering fell from station wall about the size of 7" by 7 ft in length	Jan 25	keeper carried linen and laundry to Core Bank station
1904		Mar 10	crew shingling wood house
Jan 5	a piece of plastering fell from station wall size about 2- 1/2 ft by 13 ft.	Mar 27	rd. 75 lbs white lead, 2 gal hard oil finish, 5 gal boiled linseed oil, 1 gal green paint, 2 lbs lamp black
Mar 12	in answer to "Is the house in good repair?": "good" replaced by "fair"	Apr 25	district superintendent inspects station
May 17	cleaned out cistern	May 17	painted Beebe- McClellan and Monomay surf boats
May 18, 20	hauled turf to put in and around station yard	Aug 6	motor boat "Defiance" ashore on Bush Shoal
May 27	made shelter to put monomy surf boat under	Oct 1- 2	water all around station [no tropical storm in vicinity]
Aug 17	rd. 1- 1/2 lbs of bicarbonate of soda, 4 oz. sulphuric acid for fire extinguishers	1907	
Oct 11	rd ten iron bedsteads, 80 lbs soap, 12 brooms, 12 chairs, 2 boat hooks, 60 lbs white lead, 4 gal varnish, 5 gal linseed oil, 5 lbs putty	Feb 16	"What repairs, if any, are needed upon the buildings?" was a standard entry in the station logs. Typically "none" was the answer, but on this date "porches, windows, stables, gutters, etc." was entered.
Nov 22	"so we came ashore and got keeper gas boat" [first mention of motor boats]	Mar 9	"general repairs needed"
Dec 18	crew hauling rocks and bricks to put at east side of station	May 24	crew putting stone on each side of station
Dec 30	Henry S. Davis inspects "condition of this station barn etc."	May 27	crew hauling bricks and turf to put on each side of station
1905		Jul 8	keeper fell thru wharf at Ocracoke and broke his leg
Crew in 1905:		Aug 1	Washington Roberts is acting keeper

Aug 7	crew whitewash fence and out houses	Feb 7	working on store house
Aug 11	Capt Newcomb visited station and inspected it and barn for repairs	Feb 16	finished building the dam at head of creek and will fill in same as soon as we get a sand scraper
Aug 21	Keeper returns to duty	Mar 21	building sand fence
1908		Mar 22	moving sand hill from west end of yard
May 27	Mr. George T. Hale has arrived to begin work on station	Apr 4	crew working on window screens and cleaning up yard
May 29	crew saved about \$250 worth of lumber that belong to Mr. Shull [sic], the contractor who is to repair this station	Apr 5	crew painting water closet and working on window screens
Aug 3	crew working on walks	Apr 6	making door screens
Aug 4	crew working on "horse pound"	Apr 7	crew help W. H. Babb move his house
Aug 6	crew taking up and putting down sewer pipe that Mr. Shull put down in July. He put it down 2' lower at the cistern than it was at the pipe that lead from the sink to the cistern pipe and the dirty water that come from the sink and the salt water on high tide would run down at the lower end of the pipe to the cistern and ruined the water in the cistern - - - cleaned cistern out today	Apr 9, 11, 13	crew paint window screens
Aug 7	finished walks	Apr 20	whitewashing fences
Aug 11- 15	working on "dam" on east side of station	Apr 25	working on windows for oil house
Aug 27- 29	"ground under water"; third category 1 storm that year	Apr 26	whitewashing barn
Sep 3	finished putting up yard fence	Apr 29	painted trimmings on oil house
Sep 7	crew painting keepers room	May 2	crew hauling sand in sand scoop and finished painting trimmings on store house
Sep 9	crew engaged painting cook room	May 5	putting Alabastine on lower walls
Sep 12	crew painting dining room	May 26	condemned a number of articles including 2 screen doors and 15 window screens
Sep 14	crew putting hard oil finish down stairs	May 28	sandpapered and oiled boat room floor
Sep 17	crew hard oiled boat room floor	May 31	hard oiled keepers room
Sep 28	crew making cork jackets	Aug 8	hauling turf and repairing old stables
Dec 7	crew hauling sand to fill in at northeast of station	Aug- Sep	painting trimmings on the station
Dec 28	hauling stone and brick for northeast corner of station	Sep 26	finished painting the white trimmings on the station
1909		Oct 3- 4	crew painting overhead in piazza
Mar 1	crew painted piazza floor	Oct 26	painting piazza floor
Mar 13, 16, 20	crew painting windows	Nov 5	rent 31' power boat from Harry Dixon for \$5 to make rescue in rough weather
Mar 23, 24, 26	crew painting trimmings of the station	1911	
May 10	crew landing lumber for station	Feb 11	Asst. supt. of Const. T. J. Lothar arrived to see about building a boat house
May 11	crew landing lumber for sand fence	Feb 27	hard oil boat room floor and keepers room
May 14- 15	crew putting up sand fence	Apr 17- 24	painting trimmings on station
1910		Nov 15	hard oiled boat room floor
Jan 13	crew finish foundation to privy	1912	
Jan 23	rcd. 200# white lead, 15 gal raw oil, 3# blind green paint	Mar 9	hard oil lookout and crew "setting room"
Feb 5	finish building privy	Mar 21	hard oil on doors and trimmings on second floor
		Mar 24	hard oil on siding in store room
		Apr 5	painting station trimmings
		Apr 13	crew painting porch floors
		Apr 19	crew painting cistern
		May 21	rcd. 16 window shades

1913

Feb 21 rcd. gutters for the station
 Mar 26 - 27 crew putting up gutters on station
 Apr 7 crew painting trimmings on station
 Apr 22 rcd one steel warning tower complete
 May 12 crew engaged in painting walls of the setting room on the first floor
 June 6 rcd 6 window sash painted and fitted for frames; 1000' of 2 x 4 x 16; 4000' 1 x 6 x 16 and 18 door locks with brass knobs
 Aug 18 crew painting windows
 Aug 20 crew putting locks on station
 Sep 2- 3 Cat 1 hurricane blew off top of kitchen chimney, turned over water closet, washed away part of sand fences and jetty at creek; two wrecks; destroyed Methodist church
 Sep 9 got water closet out of creek
 Sep 11 putting back sand fence
 Sep 20 reset water closet
 Oct 7- 9 crew help raise school house which blew or washed off blocks in Sep storm
 Oct 29 crew make coffin for Washington Roberts' mother
 Nov 18 rcd 184 barrells of Portland cement, 1400' 1 x 6 x 16, 610; 2 x 4 x 16; 100 lbs of 8d galvanized nails and 1 side walk maker
 Dec 17- 18 mason rebuilds cook house chimney

1914

Jan 3 rcd 1412 pcs 1 x 6 x 16; 403 pcs 4 x 4 x 8; 100# 10d galvanized nails
 Jan 14 crew painting white enamel bedsteads
 Feb 23 rcd from Harris Hdw. 250 iron rods, 1/2" x 16; and 36 pcs 3/8" x 16'
 May crew painting trimmings on station and putting up sand fence
 Jun 16 station out of water; no rain since mid-April
 Jun 19 rain
 Oct 5 Supt of Construction John S. Randall arrives

1915

Jan 12- 14 assist Mr. Latham with concrete wall; work continued throughout February
 Feb 23 crew sign enlistment papers for Coast Guard
 Feb 26- 27 crew work on sewer pipe from kitchen to creek
 Mar- Apr continuing work on concrete wall
 Mar 4, 11- 12 finish sewer pipe

May paint station trimmings
 May 9 hard oil stairs
 May 15 paint gutters
 May 21 crew finish painting U.S. Coast Guard on boats and station
 May 25 work on window screens
 Jul 29 Capt Milam H. Willis delivers 149 bas of cement on his contract
 Aug Crew on duty:
 1. Washington Roberts, Portsmouth
 2. L. D. Williams, Ocracoke
 3. Homer Harris, Stacy NC
 4. M. W. Gilgo, Portsmouth
 5. Homer Howard, Ocracoke
 6. Gary Bragg, Portsmouth
 7. Munroe Robinson, Atlantic
 8. Joe Roberts, Portsmouth
 Aug 6 161 more bags of cement delivered
 Aug 10 unloaded lumber for church
 Aug 14 rcd 99 barrells of cement, 50# 8d nails
 Aug 17 crew taking up old walks in yard
 Aug 19- 20 crew working on walks
 Aug- Sep crew putting down concrete walks
 Sep 13 work on walks in AM; haul lumber for church in PM
 Sep 14 crew work on "station walks and Inclined [sic]"
 Sep 15 crew work on "incline" on east side of station
 Sep 24 crew work on "moulds" for incline and repairing door sill in boat room
 Sep 27- 28 crew work on forms for concrete
 Oct 19 finished walks at 2:40 PM
 October work on concrete continues all through the month
 Nov 22 crew hauling shells and sand for concrete

1916

Jan 3 used up all cement and re- bar but still lack 103' completing sea wall
 Jan 5 crew oiling boat room floor
 Jan 14 Keeper ordered to Wilimington for exam as to his permanent disability; Roberts acting officer in charge
 Jan 20 crew working on "incline" to barn and putting shingles on old barn
 Jan 29 crew backfilling sea wall with sand
 Feb 17 fix screen door to cook house
 Feb 24 McWilliams retired at midnight, leaving Roberts in charge
 March 6- 7 crew measuring and surveying station
 Mar 8 Albert Barco assumes actg. officer in

May 1	telephone service restored north of station		present war
May 22	paint trimmings on station	Nov 15	crew remove varnish from interior of kitchen
Jul 15	removed varnish from dining room of station building	Nov 16	crew remove hard oil from kitchen
Jul 18	crew prepared all bright work in surfman's wash room and the dining room for receiving coat of varnish	Nov 18	Harris and Taylor return with 26' power surf boat 1553
Aug 6	Glenn Bantley Willis enlisted as cook (first cook?)	Dec 11	Rcd 20 gal straw- colored paint
Aug 20	varnish lookout and stairs	Dec 18	problems with surfboat engine
Aug 28	prepared dining room walls for painting; put in new screens	1919	
Sep 5	painted walls of plastered rooms on lower floor with alabastine	Jan 4	religious service conducted by Rev. Geo. Willis from 10 to 10:30 Sat. morning
Sep 6	crew varnish dining room of main building; painted plastered walls of dining room	Jan 7	flag at half staff on death of Teddy Roosevelt
Sep 9	buried gasoline storage tank	Jan 20	rcd. telephone message stating medical officer for Coast Guard crew was obtainable at Manteo by sea plane
Sep 11	remove varnish from doors on second floor	Jan 22	rcd. magneto for power boat but Harris couldn't install it
Sep 13	remove varnish from doors and walls in surfmen's room	Feb 3	supply ship Carolina takes surfboat 1553 for repairs and returns life boat 722 after repairs to hull
Sep 25	painted porch floors	Feb 11	Steamer Wishkah from Seattle bound for Norfolk runs aground- - - 28 crew taken to station
Oct 2	remove hard oil from keeper's bedroom	Feb 16	Wishkah crew leave station for Morehead City
Oct 9	paint window screens	Mar 6	cook Glenn Willis promoted to surfman #8 after Joe Roberts discharge
Oct 10	removed varnish from keeper's room; rcd. one rifle, Springfield, belt, sling, bayonet, scabbard, and canteen- - - 240 cartridges	Mar 13	Jesse J Babb enlisted as cook
Oct 11	crew prepared floor for paraffin oil	Mar 26	repair window screens
Oct 14	crew remove varnish from keeper's room; telephone message relating to "sea planes"	Mar 28	crew scraping hard oil from walls of kitchen
Oct 16	crew remove varnish from keeper's office	Apr 2	crew remove hard oil from walls of kitchen
Oct 18	crew remove hard oil from walls and ceilings of keeper's room	Apr 7	crew worked on walls and ceiling of kitchen
Oct 20	worked on keeper's office removing varnish	Apr 9	crew worked on interior of kitchen
Oct 23	had to take cook to doctor in Atlantic	Apr 15	crew hard oiled kitchen
Oct 25	crew sandpaper ceiling and walls in keeper's wash room	Apr 17	crew hard oiled inside of kitchen
Oct 28	crew cleaning floor of keeper's room	Apr 23	crew whitewashing station fence and old barn
Oct 30	cleaned and hard oiled keeper's room	Apr 29	crew painted windows and doors
Oct 31	varnished keeper's room	May 6	crew painted windows and doors
Nov 1	crew work on keeper's room polishing floor	Jun 10	crew paint piazza floor and cistern
Nov 6	crew employed putting hard oil in keepers room	Jun 13	crew paint boat room doors, expending 1 gal grey paint
Nov 9	Harris and Taylor leave on power life boat 722 to Elizabeth City	Aug 16	delivered life boat 722 to supply boat Carolina to be transferred to Station 192
Nov 11	3 PM rcd. telegram relating to end of	Aug 21	rcd. from Carolina power life boat 1097 and equipment transferred from Station

190
 Sep 19 Baalim, bay horse, 9 yrs old rc. Aug 14, 1916, taken with staggers
 Sep 21 horse dies
 Nov 4 crew repair and paint steel flag pole
 Nov 5 crew puts up all heating stoves
 Nov 12 sea plane lands near station with Lt. M. B. Blanchard, W. C. Hampler, R. G. Sackett of NY; spent night
 Dec 10 Norwood Roberts discharge for "inaptitude" during probationary period
 Dec 22 Jesse Babb promoted to #8

1920

Jan 2 Edw. C. Fulcher arrived from Station 190; demoted from surfman to cook at his own request to replace Babb
 Jan 21 crew repair pipes leading from cistern to sink in surfman's wash room "bursting during recent freeze"
 May 6 paint screens
 May 7 Paint windows
 May 21, 24, 31 paint trimmings on station
 Jun 3 crew paint trimmings on station and outbuildings

Crew list:

Mitchell Hamilton, Sea Level
 W. Roberts, Portsmouth
 L. D. Williams, Ocracoke
 Homer Harris, Portsmouth
 Monroe W. Gilgo, Portsmouth
 Murrery Robinson, Atlantic
 Glenn B. Willis, Atlantic
 Roy Robinson, Atlantic
 Jesse Babb, Portsmouth
 Edw. C. Fulcher, Portsmouth

Jun 9 whitewash barn and boat house\
 Jun 10 paint steel tower
 Jul 28 first mention of Pilentary Club House; also Harbor Island Clubhouse mentioned
 Dec 8 Boatswain Hamilton ordered to superintendent's office, Roberts acting

1921

Feb 6 B'son W. M. Yeomans transferred from Station 169 to take charge of 188
 Mar 3 grey horse had been sick—shot today
 Mar 7 crew work on water tank
 Mar 14 crew employed in work on tank
 Mar 15 crew working on and finishing water tank
 Apr 6 rcd. 1 dark bay horse

Crew list:

W. M. Yeomans, Portsmouth
 W. Roberts, Portsmouth
 L. P. Williams, Ocracoke
 Homer Harris, Portsmouth
 G. B. Willis, Portsmouth
 J. J. Babb, Portsmouth
 A. W. Rice, Portsmouth
 Samuel Williams, Portsmouth
 E. G. Fulcher, Portsmouth
 Harry Dixon (cook), Portsmouth

Dec 30 Message of Peace aground at inlet; ordered to be seized and cutter Pamlico summoned

1922

May 12 Power surf boat 1295 transferred to station from Station 183

1924

Jul 16 crew cutting grass in station yards
 Aug 1 rcd. 5500 shingles for station barn
 Sep 27 rcd. 11 pcs 6 x 6 x 16, 6 pcs 6 x 6 x 12, 15 pcs 3 x 6 x 12, 10 pcs 3 x 6 x 16, 18 bundles flooring
 Nov 16 J. R. Emory detached from Oregon Inlet Station to take charge here - - C. H. Wroton sent to Wash Woods Station

1925

Apr 4 Roy Robinson detached from Hatteras Inlet and put in charge of Portsmouth; Emory sent to Elizabeth City, NC
 May

Crew list:

Roy Robinson, Bosn L, Atlantic, NC
 W. P. Willis, BMC, Portsmouth, NC
 Homer Harris, MMC, Portsmouth, NC
 J. J. Babb, MMc, Portsmouth, NC
 Samuel Williams, Portsmouth, NC
 D. H. Scarborough, Portsmouth, NC
 T. C. Miller, Portsmouth, NC
 C. W. Midgett, Portsmouth, NC
 D. E. Meekins, Portsmouth, NC
 W. R. Styron, Portsmouth, NC
 Dec 17 run engines of power boats - - surfboat 1295, lifeboat 1097

1926

Feb 6 mention of Robinson's motorboat #798 being anchored at Sheep Island Slue

Feb 23	rcd. 300 gal. gasoline Standard Oil	agents in boarding vessel; found 4 gal.
Mar 5	rcd. material to repair wharf 70 pcs 3x10x16, 10 pcs 3x8x16, 169 pcs. 2x6x6, 40 pcs 2x4x16 cypress, 100# 20d nails, 100# 30d nails, 100# 60d galvanized	corn whiskey, 22 bottles home brew; seized vessel
May 20	rcd. from A.B.- 21 one barrel of lime and one Radio set	Aug 20- 21 crew repairing base of station building in afternoon
Jun 1	"Rev. Geo Willis was transferred down the beach from Core Bank, held service at this station" spent night and then taken to Ocracoke	Aug 25 crew repair and paint base of station
Dec 9	sent boat to Ocracoke for Rev. Willis	Dec 21 Robinson transferred to Ft. Macon Station- - - George Meekins (Avon, NC) takes command
Dec 10	transferred Rev. Willis to Core Bank via automobile	
1927		
Mar 2	nor'easter with snow, sleet, 75 mph winds; rescued 3 schooners and 2 motor boats; south post and key washed away; assisted in refloating boats for the next week	1932
Mar 15	schooner distress flag five miles sw of station; stranded since Mar 3; took Ford car to site, but took two days to float her	Feb 23- 25, 29 crew paint interior of station
		Mar 1- 4 ditto
		Feb 26 crew assembling tractor which has been out of commission since it first arrived at this station
		Mar 17- 18 crew making palings for fence around station
		Mar 19 delivered horses for delivery to Portsmouth, VA
		May 26, 30, 31 crew erecting station fence
		Jun 1, 6- 8 ditto
		Jul 1 Elisha G. Tillett takes command
		Jul 2 rcd. oil stove for cooking
		Jul 5 crew employed at painting wall leading to officer in charge's sleeping room in afternoon
		Jul 13 landing and hauling Tillett's furniture
		Jul 21 crew cleaning provision room
		Jul 25 crew touching up paint in company room
		Aug 22 new telephone installed
		Dec 21 repairing porch in afternoon
1928		
	[numerous entries regarding picketing of inlet]	
Oct 26	crew employed in building barn	
Nov 2, 6, 19, 20	several days spent working on barn	
Nov 8	rcd picket boat I375 in good condition	
Nov 24	rcd life boat 1560 and surfboat 1231 in good order	
1929		
	[Among the crew is Hermon W. Ritchie from Lincoln, Michigan, and Harold W. Kriewell from Port Hope, Michigan]	
Oct 19	rcd radio and equipment	
Dec 6	AB- 21 delivers material for wharf	
1930		
Aug 2	instructed crew in firing rifles and pistols	
1931		
Jan 20	Robinson leaves sick and is gone until	
June 15		
Jul 10	rcd. 300 pounds of ice from Albert Styron at Ocracoke	
Jul 24	ditto; arrived w/ tractor for station	
Jul 27	delivered tractor to Ocracoke Station	
Aug 1	rcd. 300 lbs ice; assisted prohibition	
		Aug 22 gale 50 mph in evening; "crew preparing for approaching storm in afternoon"; no patrol in PM due to extremely high tide; 9:30 PM part of fence washed down; secured it to prevent its going adrift; 10 PM water in lower rooms in station
		Aug 23 5:30 AM- - - part of wharf and wharf house gone; motor surfboat 3398 sunk to leeward of dock; fence on NE side of station gone, but telephone still working; 8AM water on lower floors
		Aug 24 rcd lumber for wharf
		Aug 29 rcd 1 barrel of kerosene
		Aug 31 cleaned cisterns for water supply
		Sep 15 making preparation for storm as far as possible; by midnight winds over 90mph; 10PM water on all lower floors of station and in all buildings

- Sep 16 “flag tower blew down just after mid-night; launched surfboats 4097 and 579 at 3 AM and moored them to leeward of station as station was surging badly and expected to go away”; water 10” deep in lower rooms; all crews’ families at station for protection; at daylight discovered all of station fence gone, chimney down on kitchen, shingles off NE side of barn; both patrol houses “had gone away in storm”
- Sep 28 Red Cross sends supplies to Portsmouth
- Oct 6 crew repair incline to barn and install new barn door
- Nov 3 Elisha G. Tillett appointed chief boatswains mate lifesaving
- 1934**
- Jan 7 telephone service restored
- Feb 14 three men assigned from Core Bank Station until it can be repaired
- Mar 9 outbuildings in need of repairs from storms
- Mar 14 supt. of const. L. J. Jordan arrives to take inventory of needed work
- Apr 11 Luther Jordan spends morning at station “for purpose of gaining information in regard to repair of station buildings,
- making sketches, etc.
- Crew members:
 Elisha G. Tillet, Wanchese, NC
 Troy Morris, New Bern, NC
 Roland Styron, Davis, NC
 Harvey Taylor, Sea Level, NC
 Wilbur S. Goodwin, Lola, NC
 Whelington Robinson, Atlantic, NC
 Horatio G. Midgett, Rodanthe, NC
 Walter Goodwin, Roe, NC
 Thomas H. Nelson, Marshallburg, NC
 Julian L. Gray, Rodanthe, NC
 Shanklin S. Fulcher, Frisco, NC
 Garfield Emory, Roe, NC
- 1935**
- Jan 23 Julian L. Gray assumes command; “buildings are in need of repair due to damage done by storms,” an entry that is routinely repeated until station is closed in 1937
- 1937**
- May 26 crew repair window screens; letter rcd. announcing decommissioning of station
- May 31 inventory of equipment
- Jun 1 station decommissioned at sunset



The National Park Service cares for special places saved by the American people so that all may experience our heritage.

